

catálogo 2022/2023
www.spotline.com.br

spotline
iluminação



Baixe os modelos 3D para SketchUp,
acesse o QR-Code ao lado.



*ACENDA TODA SUA CRIATIVIDADE!
ILUMINE SEUS PROJETOS E SUA VIDA COM
FEIXES DE INOVAÇÃO E AUTENTICIDADE.
INSPIRE-SE BRILHE COM A SPOT LINE!*

O catálogo Spot Line 2022/2023, apresenta as novas linhas de produtos desenvolvidos para atender as demandas do mercado de iluminação, decoração e arquitetura.

Traz também as linhas “best seller”, coleções anteriores que já são conhecidas e fazem sucesso.

Nossos produtos acompanham as tendências do mercado de iluminação, com acabamento de alta qualidade, iluminação em LED e pintura em diversos acabamentos.

A Spot Line foi fundada em 1991, possui sede própria em São Paulo e atende todo o território nacional.

Tabela de Cores

| | | | | | |
|---|---|---------------------|----|---|--------------------|
| 1 |  | BF - Branco Fosco | 9 |  | DR/O - Dourado Ono |
| 2 |  | CA- Café | 10 |  | LX - Lixado |
| 3 |  | CO/L - Cobre Lixado | 11 |  | PO - Polido |
| 4 |  | CO/P - Cobre Polido | 12 |  | PT - Preto |
| 5 |  | CO/O - Cobre Ono | 13 |  | TC - Terracota |
| 6 |  | CR - Concreto | 14 |  | RO - Rosê |
| 7 |  | DP - Dourado Polido | | | |
| 8 |  | DL - Dourado Lixado | | | |

Exemplo de Combinações de Cores

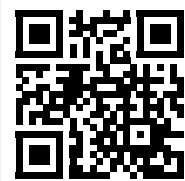
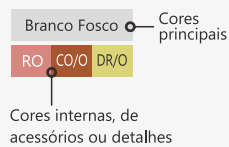

Abra o leitor QR Code em seu celular ou tablet e foque no código com a câmera. Depois clique em ler código para acessar nosso site.

| | | | | | |
|-----------------|----|---------------|----|-----------------|-----|
| print..... | 4 | pisa | 47 | only..... | 81 |
| score..... | 8 | mônaco | 48 | aria | 82 |
| mark | 10 | grécia..... | 48 | office | 84 |
| bank..... | 11 | frame..... | 49 | road | 85 |
| prisma | 12 | soul..... | 50 | hall..... | 85 |
| small..... | 13 | hook | 51 | vanity..... | 86 |
| connect | 14 | unique | 52 | style..... | 87 |
| case | 16 | cruze..... | 53 | verssat..... | 90 |
| halo | 19 | zurich..... | 54 | long | 90 |
| planet | 20 | power | 55 | century..... | 91 |
| filadélfia..... | 21 | shine..... | 56 | angulus..... | 92 |
| orion..... | 22 | alamo | 57 | rob..... | 92 |
| foco | 23 | summer | 58 | soft | 93 |
| hight | 27 | grau | 59 | argo | 93 |
| cordoba | 28 | honda | 60 | bronx | 94 |
| thin | 29 | ávila | 61 | queens..... | 95 |
| twist..... | 30 | hills | 62 | martin..... | 96 |
| corner..... | 31 | gemini | 63 | square | 97 |
| blown | 32 | madri..... | 64 | prime..... | 97 |
| veneza | 33 | double | 66 | new smart | 98 |
| parma | 34 | vega | 67 | smart | 99 |
| novara | 35 | vale..... | 68 | panamera | 100 |
| torcia | 35 | delta | 69 | ellos | 101 |
| string | 35 | cali | 69 | astra | 101 |
| ipê | 36 | vigo..... | 69 | kamilla..... | 102 |
| stelo..... | 37 | glass..... | 70 | empire..... | 103 |
| esteca | 38 | delta | 71 | drop..... | 104 |
| lina..... | 38 | uno | 71 | tiger | 105 |
| volare | 39 | pêndulo | 72 | vitara | 105 |
| cake | 40 | gota | 74 | city..... | 106 |
| pipe | 42 | tromp | 75 | dix..... | 107 |
| imola | 43 | torch..... | 75 | denver | 107 |
| malta | 43 | shell | 76 | oxford | 108 |
| iglu..... | 44 | dome | 76 | zeus | 109 |
| maia..... | 44 | haste..... | 77 | globo | 109 |
| atena | 45 | búzios..... | 77 | flex..... | 110 |
| savana | 46 | maze..... | 78 | tróia..... | 110 |
| carpi | 46 | kit | 79 | usina..... | 111 |
| draft..... | 47 | event | 80 | | |



1012 – perfil sobrepор print LED
mini spot



1013 – perfil sobrepор print LED
mini globo

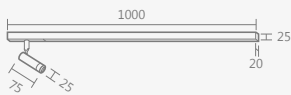

1012/1 – 1000mm

- 14 watts + 3 watts – bivolt
- 1275 lumens

| ID | COR | COR LED |
|------|--------|---------|
| 4599 | preto | 3000K |
| 4600 | branco | |
| 4603 | preto | 4000K |
| 4604 | branco | |



1013/1 – 1000mm

- 14 watts + 2 watts – bivolt
- 1200 lumens

| ID | COR | COR LED |
|------|--------|---------|
| 4453 | preto | 3000K |
| 4451 | branco | |
| 4455 | preto | 4000K |
| 4454 | branco | |



1012/1,5 – 1500mm

- 24 watts + 3 watts – bivolt
- 2025 lumens

| ID | COR | COR LED |
|------|--------|---------|
| 4606 | preto | 3000K |
| 4608 | branco | |
| 4609 | preto | 4000K |
| 4452 | branco | |



1013/1,5 – 1500mm

- 24 watts + 2 watts – bivolt
- 1950 lumens

| ID | COR | COR LED |
|------|--------|---------|
| 4456 | preto | 3000K |
| 4457 | branco | |
| 4458 | preto | 4000K |
| 4460 | branco | |



1014 – perfil sobrepор print LED pendente mini spot



1015 – perfil sobrepор print LED pendente mini globo

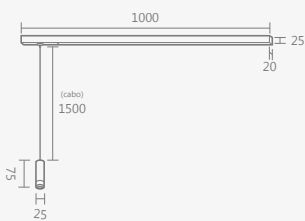

1014/1 – 1000mm

- 14 watts + 3 watts – bivolt
- 1275 lumens

| ID | COR | COR LED |
|------|--------|---------|
| 4462 | preto | 3000K |
| 4464 | branco | |
| 4465 | preto | 4000K |
| 4466 | branco | |

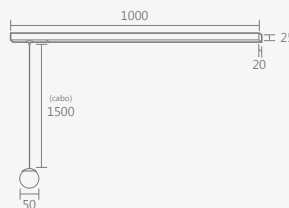

1015/1 – 1000mm

- 14 watts + 2 watts – bivolt
- 1200 lumens

| ID | COR | COR LED |
|------|--------|---------|
| 4479 | preto | 3000K |
| 4483 | branco | |
| 4485 | preto | 4000K |
| 4487 | branco | |



1014/1,5 – 1500mm

- 24 watts + 3 watts – bivolt
- 2025 lumens

| ID | COR | COR LED |
|------|--------|---------|
| 4472 | preto | 3000K |
| 4474 | branco | |
| 4476 | preto | 4000K |
| 4477 | branco | |



1015/1,5 – 1500mm

- 24 watts + 2 watts – bivolt
- 1950 lumens

| ID | COR | COR LED |
|------|--------|---------|
| 4489 | preto | 3000K |
| 4491 | branco | |
| 4494 | preto | 4000K |
| 4495 | branco | |



1024 – perfil print pendente LED mini spot



1025 – perfil print pendente LED mini globo

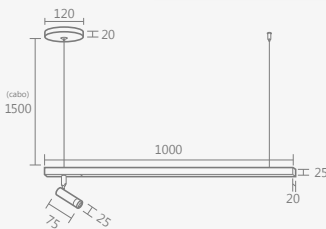

1024/1 – 1000mm

- 14 watts + 3 watts – bivolt
- 1275 lumens

| ID | COR | COR LED |
|------|--------|---------|
| 4534 | preto | 3000K |
| 4533 | branco | |
| 4536 | preto | 4000K |
| 4535 | branco | |

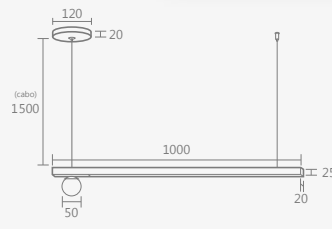

1025/1 – 1000mm

- 14 watts + 2 watts – bivolt
- 1200 lumens

| ID | COR | COR LED |
|------|--------|---------|
| 4542 | preto | 3000K |
| 4541 | branco | |
| 4544 | preto | 4000K |
| 4543 | branco | |

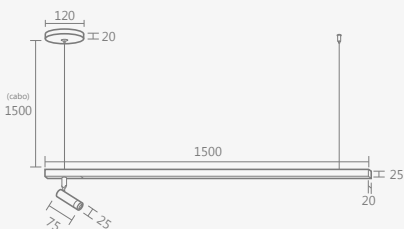

1024/1,5 – 1500mm

- 24 watts + 3 watts – bivolt
- 2025 lumens

| ID | COR | COR LED |
|------|--------|---------|
| 4538 | preto | 3000K |
| 4537 | branco | |
| 4540 | preto | 4000K |
| 4539 | branco | |

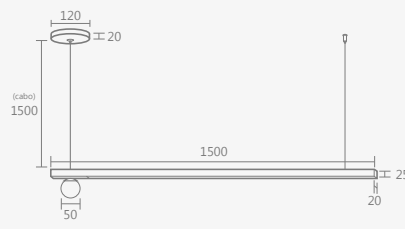

1025/1,5 – 1500mm

- 24 watts + 2 watts – bivolt
- 1950 lumens

| ID | COR | COR LED |
|------|--------|---------|
| 4546 | preto | 3000K |
| 4545 | branco | |
| 4548 | preto | 4000K |
| 4547 | branco | |



1016/2 – perfil print arandela LED mini spot



1017/2 – perfil print arandela LED mini globo

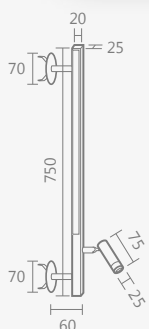

- 11 watts + 3 watts – bivolt
- 1050 lumens

| ID | COR | COR LED |
|------|--------|---------|
| 4496 | preto | 3000K |
| 4497 | branco | |
| 4498 | preto | 4000K |
| 4499 | branco | |

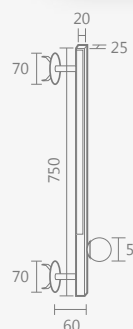

- 11 watts + 2 watts – bivolt
- 975 lumens

| ID | COR | COR LED |
|------|--------|---------|
| 4500 | preto | 3000K |
| 4501 | branco | |
| 4502 | preto | 4000K |
| 4503 | branco | |

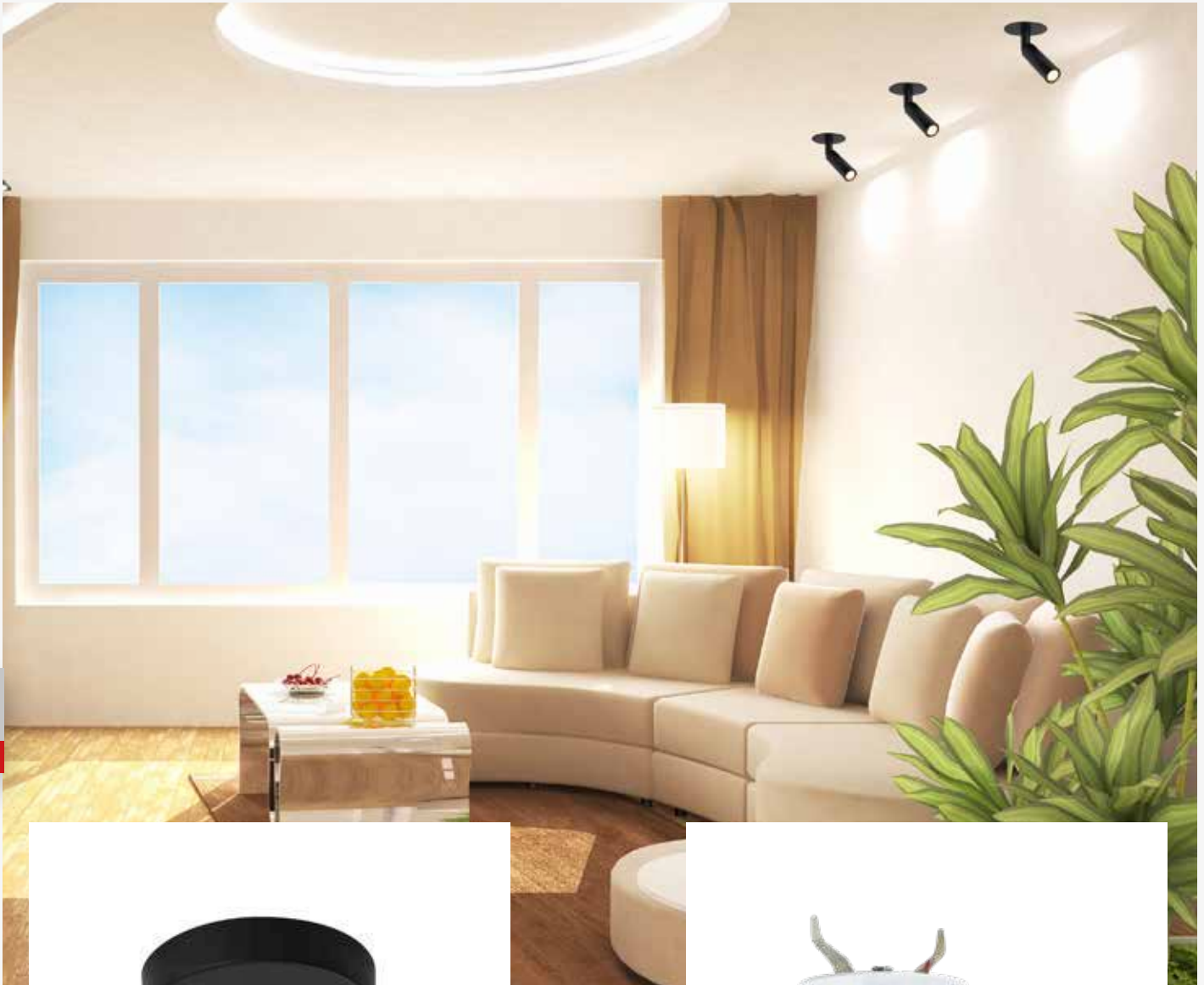

996/1 – mini spot score

- 3 watts – bivolt
- 225 lumens

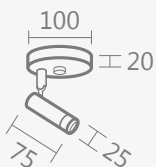

| ID | COR | COR LED |
|------|----------------|---------|
| 4484 | branco | 3000K |
| 4486 | preto | |
| 4488 | dourado lixado | |
| 4597 | dourado ono | |
| 4490 | branco | 4000K |
| 4492 | preto | |
| 4493 | dourado lixado | |
| 4598 | dourado ono | |



995/1 – mini spot score para gesso

- 3 watts – bivolt
- 225 lumens



| ID | COR | COR LED |
|------|----------------|---------|
| 4286 | preto | 3000K |
| 4285 | branco | |
| 4287 | dourado lixado | |
| 4445 | dourado ono | |
| 4289 | preto | 4000K |
| 4288 | branco | |
| 4290 | dourado lixado | |
| 4446 | dourado ono | |



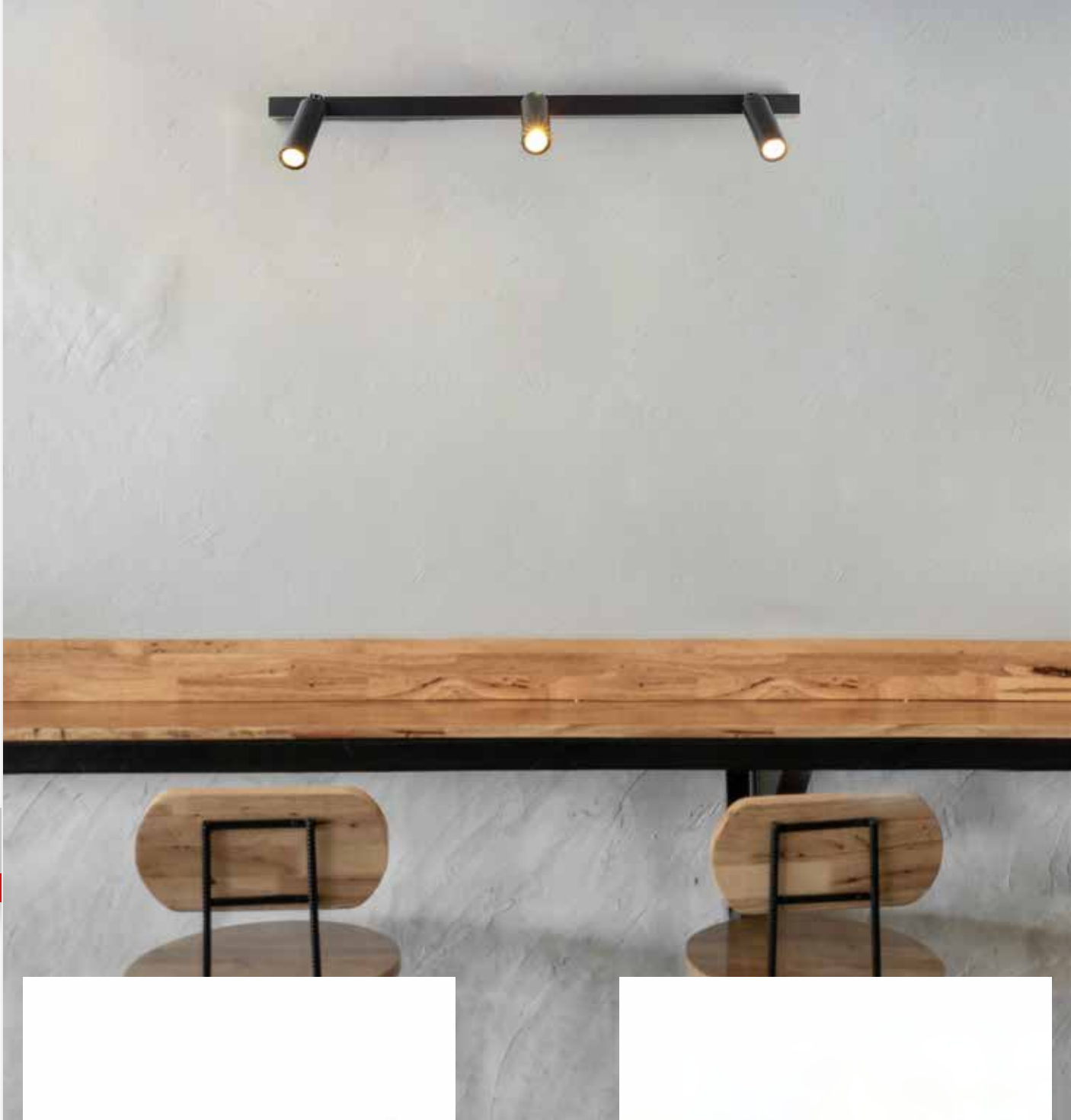

995/2 – mini spot duplo score

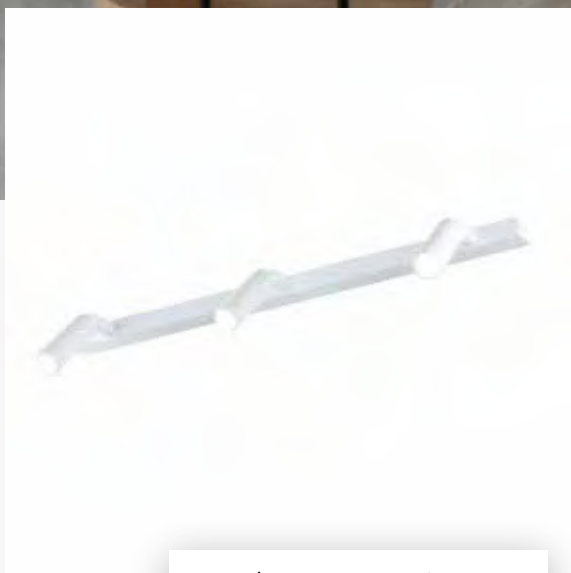

995/3 – mini spot triplo score



- 5 watts – bivolt
- 375 lumens

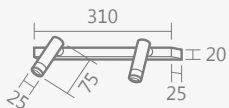

| ID | COR | COR LED |
|------|-------------|---------|
| 4463 | preto | 3000K |
| 4459 | branco | |
| 4470 | dourado ono | |
| 4469 | preto | 4000K |
| 4467 | branco | |
| 4471 | dourado ono | |

- 7 watts – bivolt
- 525 lumens

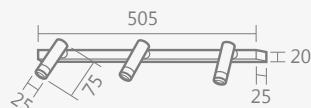

| ID | COR | COR LED |
|------|-------------|---------|
| 4473 | preto | 3000K |
| 4684 | branco | |
| 4481 | dourado ono | |
| 4478 | preto | 4000K |
| 4685 | branco | |
| 4482 | dourado ono | |



1041/1 – arandela mark

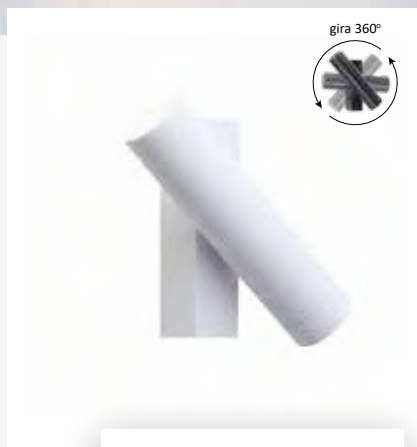

1042/2 – arandela mark

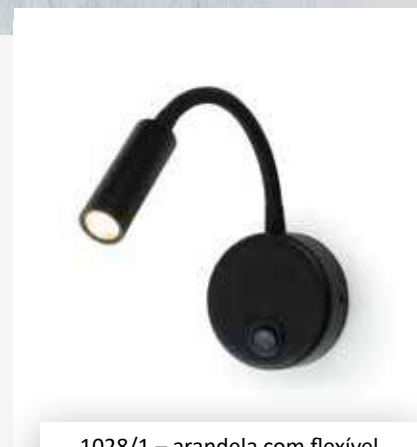

1028/1 – arandela com flexível
mini spot

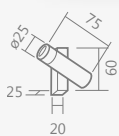

- 1 faixa
- 3 watts – bivolt
- 225 lumens

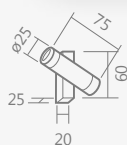

- 2 faixos
- 5 watts – bivolt
- 375 lumens

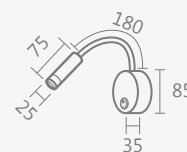

- 3 watts – bivolt
- 225 lumens

| ID | COR | COR LED |
|------|----------------|---------|
| 4753 | branco | 3000K |
| 4754 | preto | |
| 4755 | dourado ono | 4000K |
| 4756 | dourado lixado | |
| 4757 | branco | |
| 4758 | preto | 4000K |
| 4759 | dourado ono | |
| 4760 | dourado lixado | |

| ID | COR | COR LED |
|------|----------------|---------|
| 4761 | branco | 3000K |
| 4762 | preto | |
| 4763 | dourado ono | 4000K |
| 4764 | dourado lixado | |
| 4765 | branco | |
| 4766 | preto | 4000K |
| 4767 | dourado ono | |
| 4768 | dourado lixado | |

| ID | COR | COR LED |
|------|--------|---------|
| 4565 | preto | 3000K |
| 4566 | branco | |
| 4567 | preto | 4000K |
| 4568 | branco | |

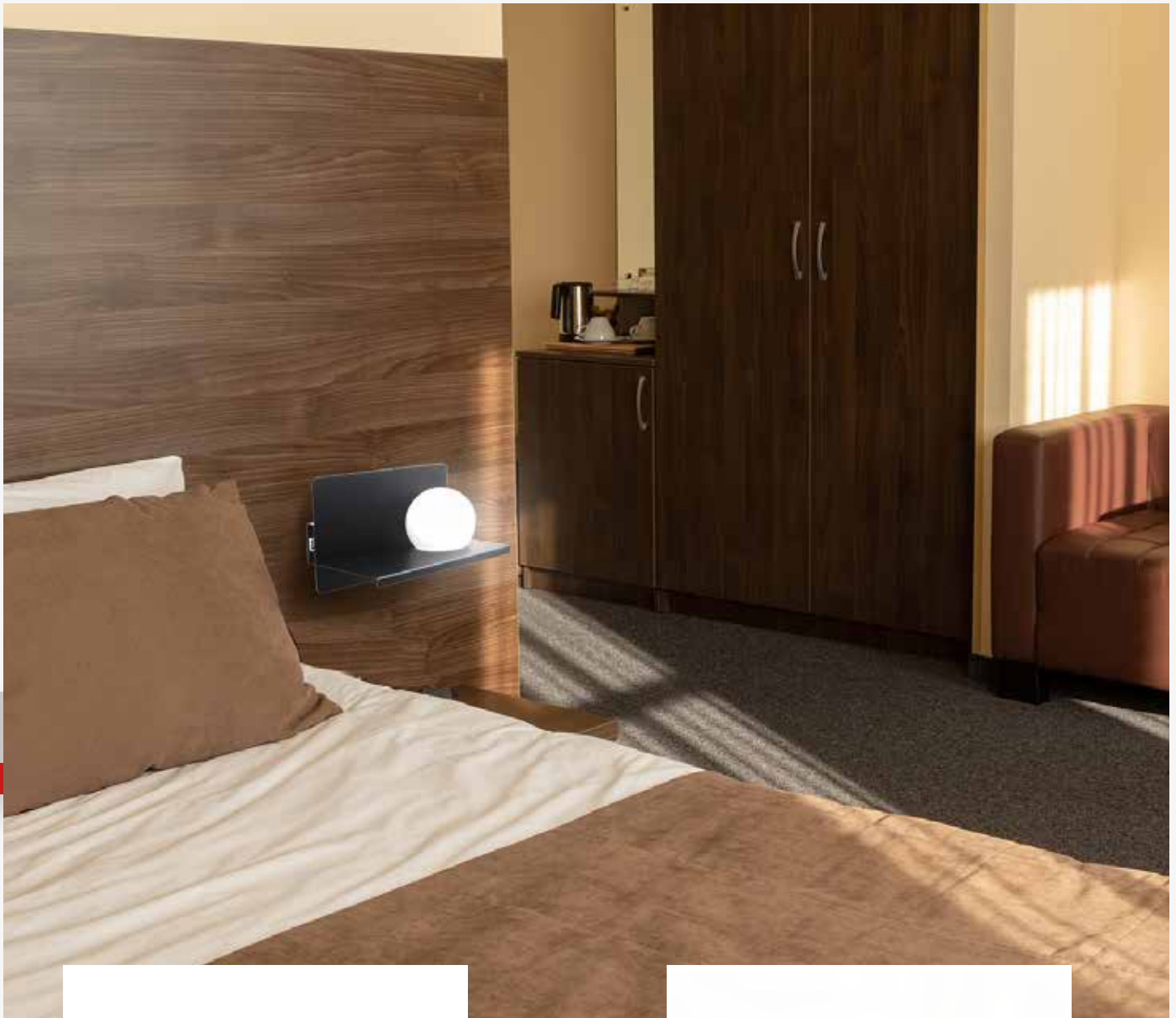

1002/1 – arandela com apoio para celular
globo Ø100mm bank

• 1 globo vidro leitoso Ø100mm - 1 x G9

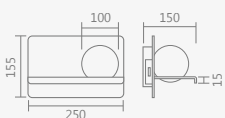

| ID | COR |
|------|-------------|
| 4643 | preto |
| 4642 | branco |
| 4644 | dourado ono |

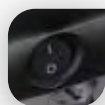

botão
liga/desliga
na peça



1003/1 – arandela com apoio para celular
mini spot flexível bank

• 3 watts – bivolt
• 225 lumens

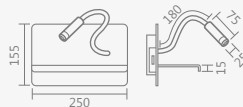

| ID | COR | COR LED |
|------|--------|---------|
| 4646 | preto | 3000K |
| 4645 | branco | |
| 4648 | preto | |
| 4647 | branco | 4000K |



linha. prisma

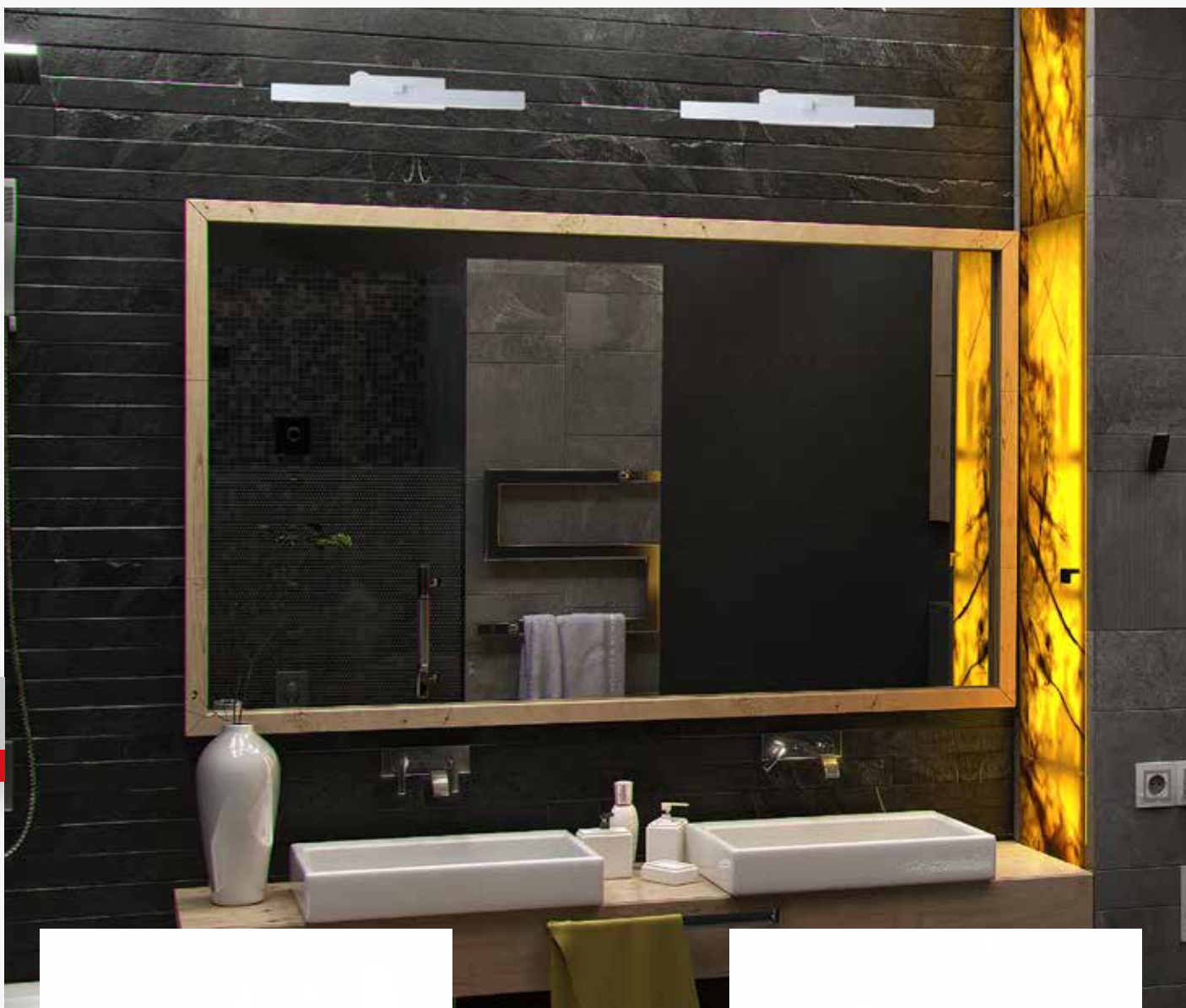

12

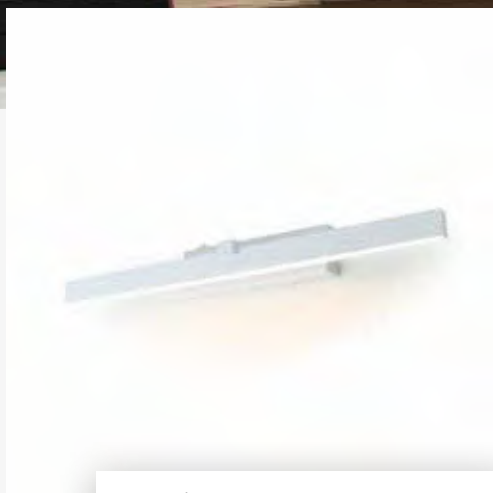

993/40 – arandela prisma 400mm

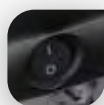

botão
liga/desliga
na peça



993/60 – arandela prisma 600mm

- 6 watts – bivolt
- 450 lumens

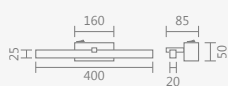

| ID | COR | COR LED |
|------|-------------|---------|
| 4276 | branco | 3000K |
| 4277 | preto | |
| 4441 | dourado ono | 4000K |
| 4278 | branco | |
| 4279 | preto | |
| 4442 | dourado ono | |

- 9 watts – bivolt
- 675 lumens

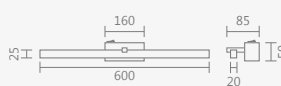

| ID | COR | COR LED |
|------|-------------|---------|
| 4313 | branco | 3000K |
| 4314 | preto | |
| 4443 | dourado ono | 4000K |
| 4316 | branco | |
| 4317 | preto | |
| 4444 | dourado ono | |

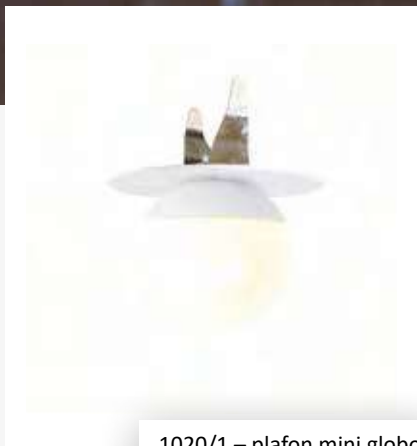
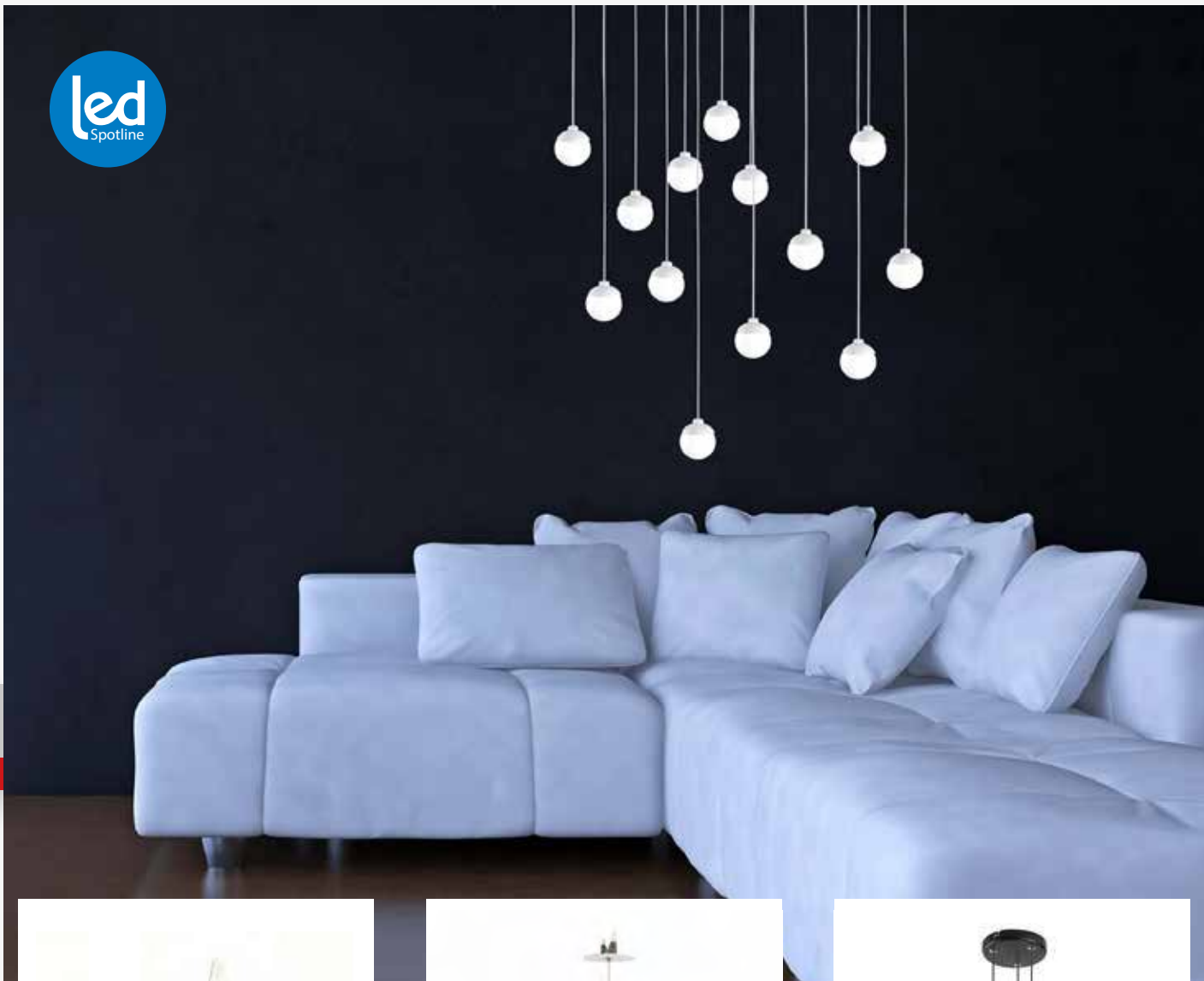

1020/1 – plafon mini globo small para gesso

- 2 watts – bivolt
- 150 lumens

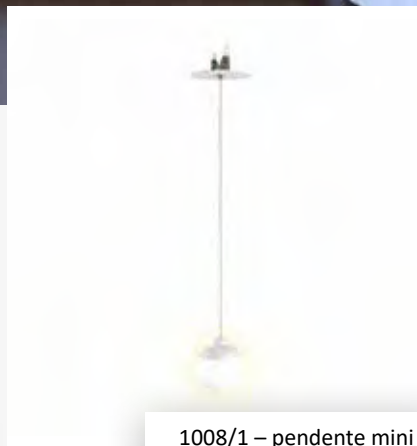

1008/1 – pendente mini globo small para gesso

- 2 watts – bivolt
- 150 lumens

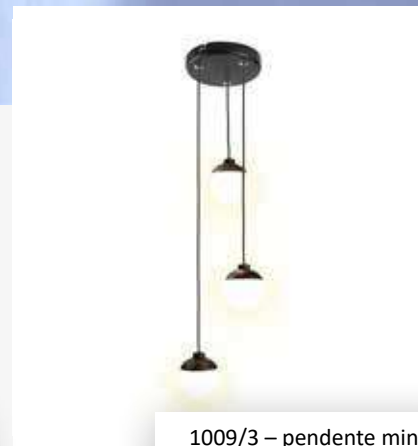

1009/3 – pendente mini globo small

- 5 watts – bivolt
- 375 lumens

70
50

| ID | COR | COR LED |
|------|--------|---------|
| 4509 | branco | 3000K |
| 4508 | preto | |
| 4511 | branco | 4000K |
| 4510 | preto | |



| ID | COR | COR LED |
|------|--------|---------|
| 4580 | branco | 3000K |
| 4579 | preto | |
| 4582 | branco | 4000K |
| 4581 | preto | |

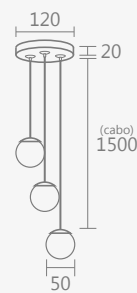

| ID | COR | COR LED |
|------|--------|---------|
| 4584 | branco | 3000K |
| 4583 | preto | |
| 4586 | branco | 4000K |
| 4585 | preto | |

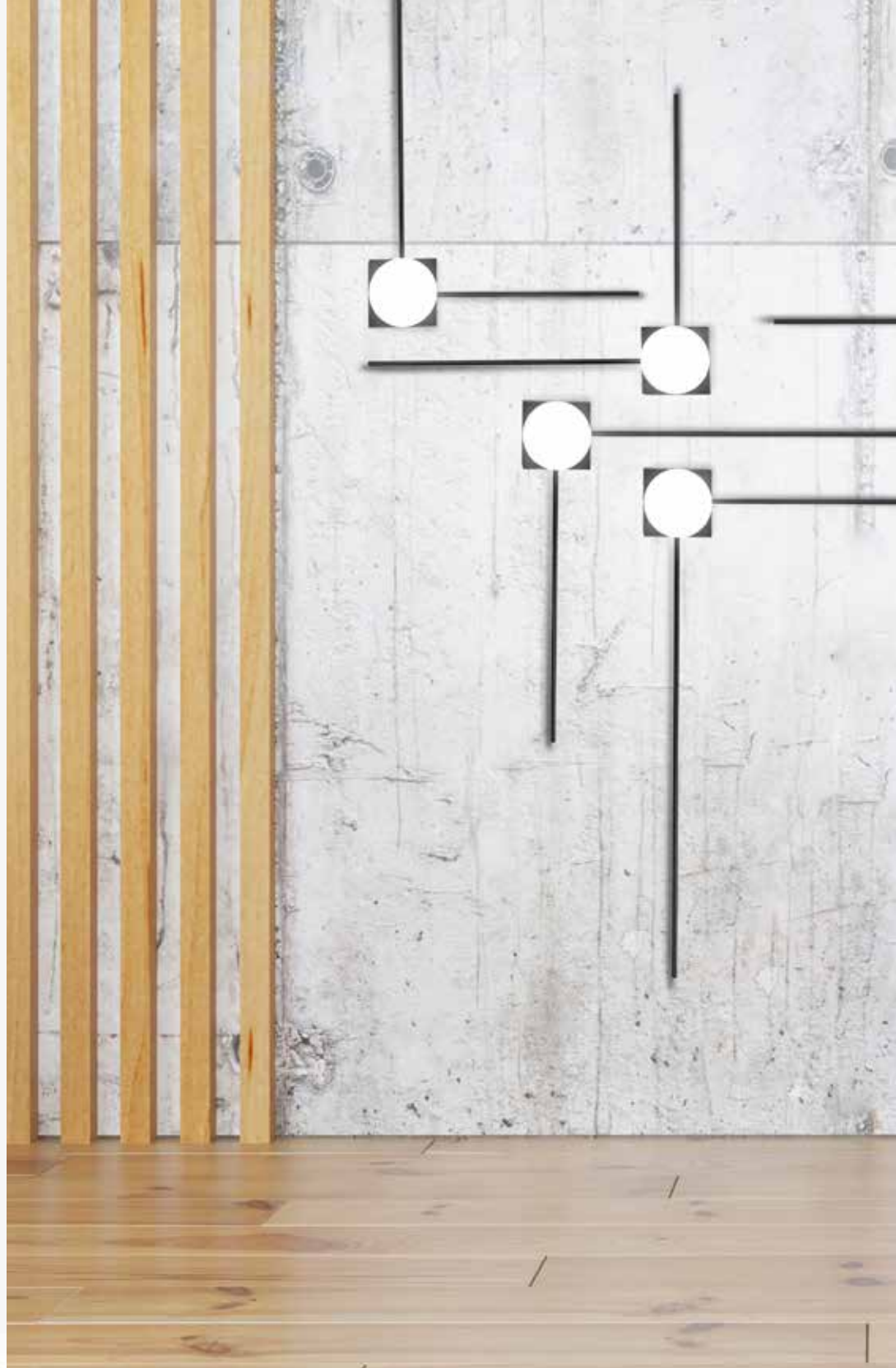

998/100 – arandela connect
globo \varnothing 100mm

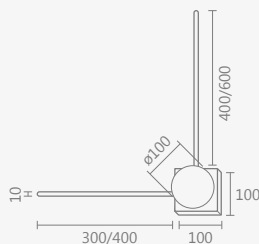

• 1 globo vidro leitoso \varnothing 100mm - 1 x G9

| ID | COR | MEDIDA DAS HASTES |
|------|----------------|-------------------|
| 4612 | branco | 300 x 400mm |
| 4620 | branco | 300 x 600mm |
| 4621 | branco | 400 x 600mm |
| 4613 | preto | 300 x 400mm |
| 4622 | preto | 300 x 600mm |
| 4623 | preto | 400 x 600mm |
| 4614 | dourado ono | 300 x 400mm |
| 4624 | dourado ono | 300 x 600mm |
| 4625 | dourado ono | 400 x 600mm |
| 4615 | dourado lixado | 300 x 400mm |
| 4626 | dourado lixado | 300 x 600mm |
| 4627 | dourado lixado | 400 x 600mm |



998/120 – arandela connect globo \varnothing 120mm

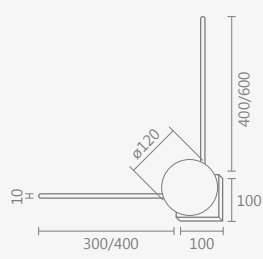

• 1 globo vidro leitoso \varnothing 120mm - 1 x G9

| ID | COR | MEDIDA DAS HASTES |
|------|----------------|-------------------|
| 4616 | branco | 300 x 400mm |
| 4628 | branco | 300 x 600mm |
| 4629 | branco | 400 x 600mm |
| 4617 | preto | 300 x 400mm |
| 4630 | preto | 300 x 600mm |
| 4631 | preto | 400 x 600mm |
| 4618 | dourado onó | 300 x 400mm |
| 4724 | dourado onó | 300 x 600mm |
| 4725 | dourado onó | 400 x 600mm |
| 4619 | dourado lixado | 300 x 400mm |
| 4726 | dourado lixado | 300 x 600mm |
| 4727 | dourado lixado | 400 x 600mm |



1019/30 – plafon case com mini spot



1021/30/30 – plafon case luz direta e indireta

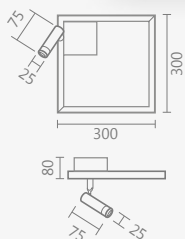

- 19 watts + 3 watts – bivolt
- 1650 lumens

| ID | COR | COR LED |
|------|-------------------|---------|
| 4505 | preto/spot branco | 3000K |
| 4504 | preto/spot preto | |
| 4507 | preto/spot branco | |
| 4506 | preto/spot preto | 4000K |

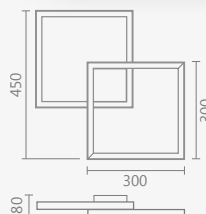

- 44 watts – bivolt
- 3300 lumens

| ID | COR | COR LED |
|------|--------|---------|
| 4513 | branco | 3000K |
| 4512 | preto | |
| 4515 | branco | 4000K |
| 4514 | preto | |



824/30 – plafon case

- 22 watts – bivolt
- 1650 lumens

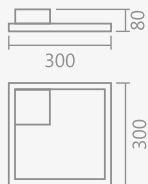

| ID | COR | COR LED |
|------|-------------|---------|
| 1433 | preto | 3000K |
| 1434 | branco | |
| 2469 | cobre ono | |
| 2537 | dourado ono | |
| 4911 | cobre ono | 4000K |
| 1435 | preto | |
| 2252 | branco | |
| 4912 | dourado ono | |



824/30-40 – plafon case

- 45 watts – bivolt
- 3375 lumens

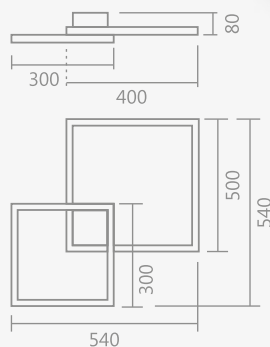

| ID | COR | COR LED |
|------|-------------|---------|
| 1441 | preto | 3000K |
| 1443 | branco | |
| 1869 | cobre ono | |
| 1445 | dourado ono | |
| 1446 | preto | 4000K |
| 4740 | cobre ono | |
| 1444 | branco | |
| 4915 | dourado ono | |



824/30-30 – plafon case



827/30-30 – pendente case

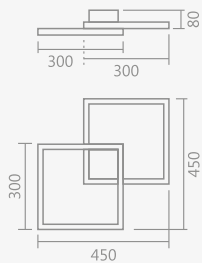

- 40 watts – bivolt
- 3000 lumens

| ID | COR | COR LED |
|------|-------------|---------|
| 1438 | dourado ono | 3000K |
| 1439 | preto | |
| 2206 | branco | |
| 3217 | cobre ono | |
| 1437 | branco | 4000K |
| 1440 | preto | |
| 2452 | dourado ono | |
| 4914 | cobre ono | |

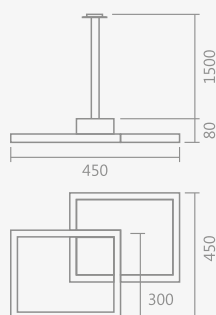

- 40 watts – bivolt
- 3000 lumens

| ID | COR | COR LED |
|------|-------------|---------|
| 1456 | branco | 3000K |
| 1457 | preto | |
| 2267 | cobre ono | |
| 2359 | dourado ono | |
| 2373 | dourado ono | 4000K |
| 1880 | preto | |
| 2201 | branco | |
| 4916 | cobre ono | |

linha halo



19



1027/40 – pendente halo 400mm



1026/60 – pendente halo 600mm



- 2 globos vidro leitoso de $\varnothing 80\text{mm}$ – 2 x G9
- 1 mini spot LED 3000K
- 3 watts – bivolt
- 225 lumens

- 4 globos vidro leitoso de $\varnothing 80\text{mm}$ – 4 x G9
- 2 mini spots LED 3000K
- 5 watts – bivolt
- 375 lumens

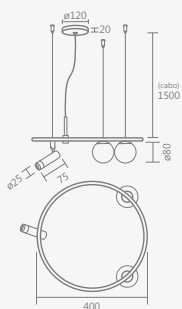

1027/40 – para gesso

| ID | COR |
|------|-------------|
| 4557 | branco |
| 4558 | preto |
| 4559 | dourado ono |
| 4560 | cobre ono |

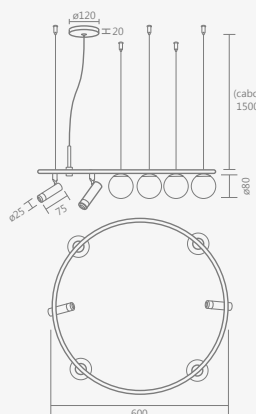

1027/60 – para gesso

| ID | COR |
|------|-------------|
| 4561 | branco |
| 4562 | preto |
| 4563 | dourado ono |
| 4564 | cobre ono |



1026/40 – com canopla

| ID | COR |
|------|-------------|
| 4549 | branco |
| 4550 | preto |
| 4551 | dourado ono |
| 4552 | cobre ono |



1026/60 – com canopla

| ID | COR |
|------|-------------|
| 4553 | branco |
| 4554 | preto |
| 4555 | dourado ono |
| 4556 | cobre ono |



linha planet



889/2 – arandela planet



1007/6 – pendente planet

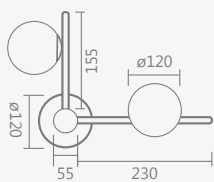

• 2 globos vidro ø120mm – 2 x G9

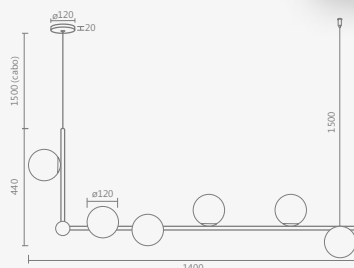

• 6 globos vidro ø120mm – 6 x G9

| globo ambar | |
|-------------|-----------------------|
| ID | COR |
| 4244 | preto/dourado lixado |
| 4245 | preto |
| 4247 | dourado lixado |
| 4248 | branco/dourado lixado |
| 4870 | dourado ono |

| globo leitoso | |
|---------------|-----------------------|
| ID | COR |
| 4434 | preto/dourado lixado |
| 4435 | preto |
| 4436 | dourado lixado |
| 4437 | branco/dourado lixado |
| 4856 | dourado ono |

| globo ambar | |
|-------------|-----------------------|
| ID | COR |
| 4665 | preto |
| 4666 | branco |
| 4667 | dourado lixado |
| 4668 | preto/ dourado lixado |
| 4869 | dourado ono |

| globo leitoso | |
|---------------|-----------------------|
| ID | COR |
| 4669 | preto |
| 4670 | branco |
| 4671 | dourado lixado |
| 4672 | preto/ dourado lixado |
| 4857 | dourado ono |

linha filadélfia

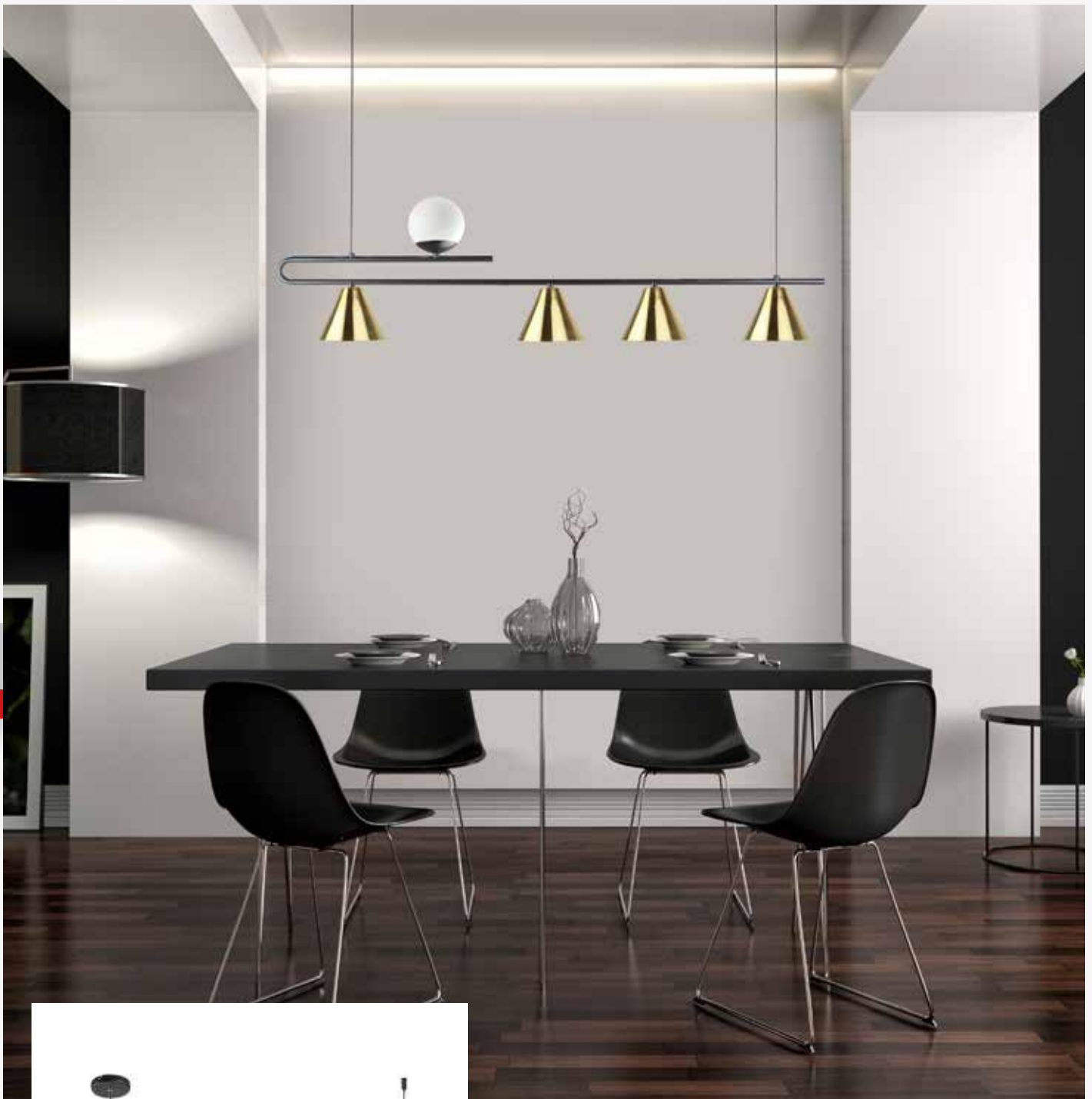

21



1004/5 – pendente filadélfia

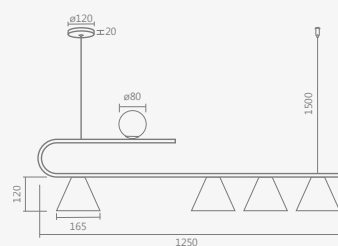

- 1 globo vidro leitoso $\varnothing 80\text{mm}$ – 1 x G9
- 4 cúpulas – 1 x E27

| ID | COR |
|------|-----------------------|
| 4649 | preto |
| 4650 | branco |
| 4651 | preto/cobre lixado |
| 4652 | preto/dourado lixado |
| 4653 | branco/dourado lixado |
| 4654 | dourado onco |

linha. orion

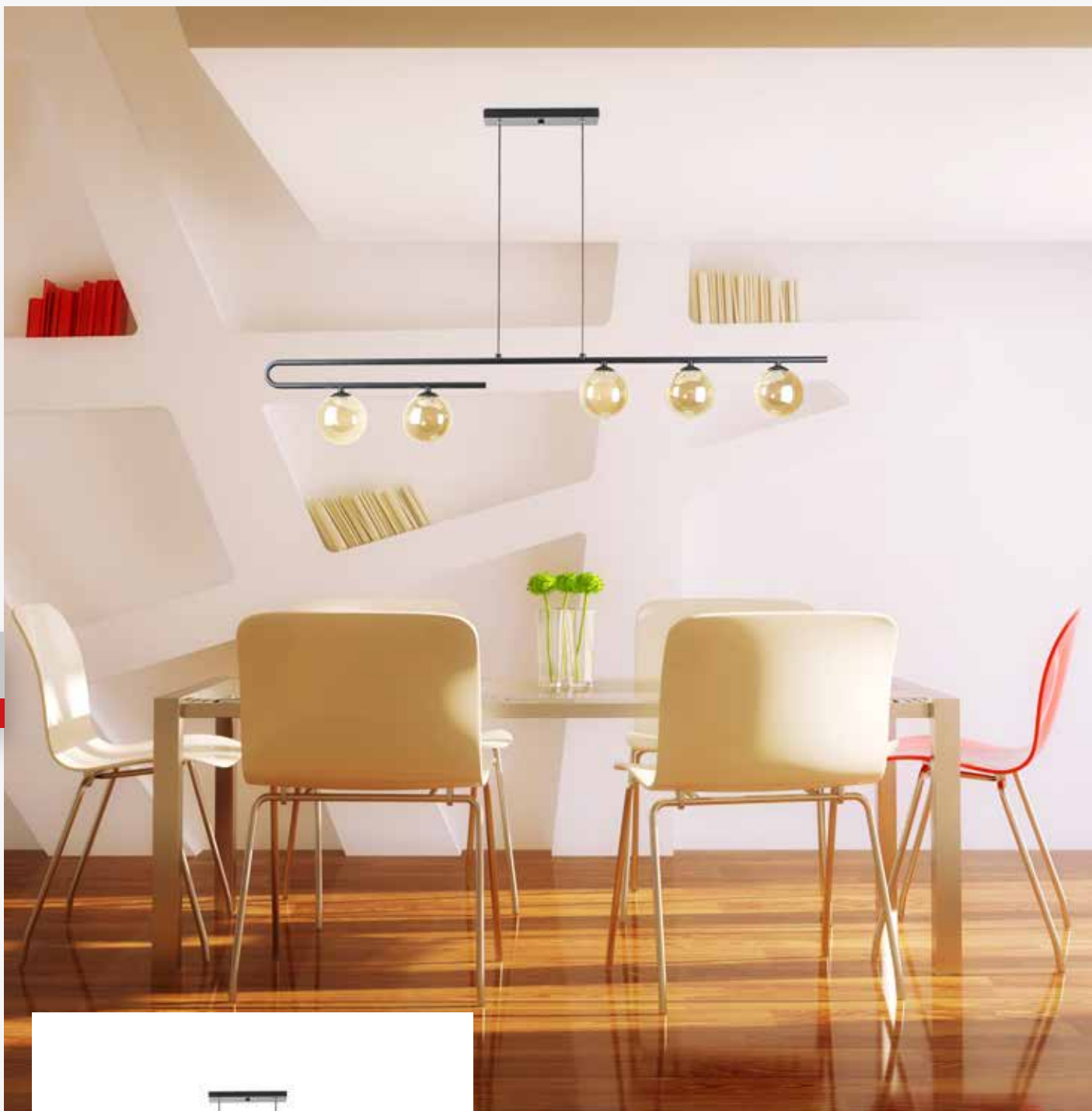

22



1005/5 – pendente orion

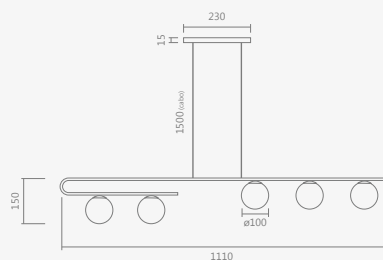

• 5 globos vidro $\varnothing 100\text{mm}$ – 5 x G9

globo duo ambar

| ID | COR |
|------|-------------|
| 4655 | preto |
| 4656 | branco |
| 4657 | dourado ono |

globo leitoso

| ID | COR |
|------|-------------|
| 4658 | preto |
| 4659 | branco |
| 4660 | dourado ono |



1006/6 – pendente foco

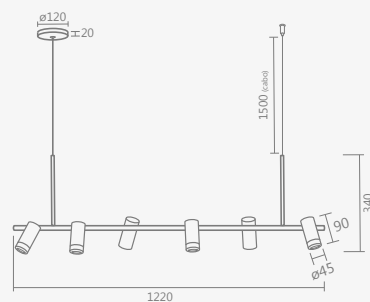

• 6 spots MR11 – 6 x GU10

| ID | COR |
|------|----------------------|
| 4661 | preto |
| 4662 | branco |
| 4663 | dourado ono |
| 4664 | preto/dourado polido |



994/1 – spot foco para gesso

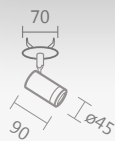

- 1 spot MR11 – 1 x GU10

| ID | COR |
|------|----------------------|
| 4280 | dourado lixado |
| 4281 | preto/dourado lixado |
| 4680 | cobre lixado |
| 4282 | preto |
| 4283 | branco |
| 4284 | preto/cobre lixado |



855/1 – spot foco

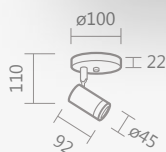

- 1 spot MR11 – 1 x GU10

| ID | COR |
|------|-----------------------|
| 2882 | preto |
| 2883 | dourado lixado |
| 2886 | preto/dourado lixado |
| 2888 | preto/cobre lixado |
| 3827 | branco/dourado lixado |



855/2 – spot duplo foco

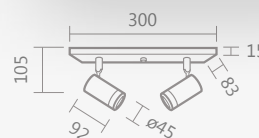

- 2 spot MR11 – 2 x GU10

| ID | COR |
|------|-----------------------|
| 2890 | preto |
| 2893 | dourado lixado |
| 2897 | preto/dourado lixado |
| 2899 | preto/cobre lixado |
| 3828 | branco/dourado lixado |



855/3 – spot triplo foco

• 3 spots MR11 – 3 x GU10

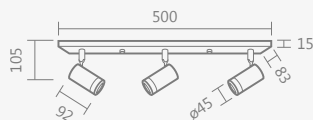

| ID | COR |
|------|----------------------|
| 2901 | preto |
| 2903 | dourado lixado |
| 2904 | preto/dourado lixado |
| 2905 | preto/cobre lixado |



856/1 – pendente foco

• 1 spot MR11 – 1 x GU10

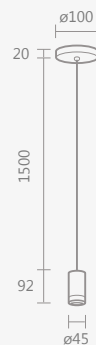

| ID | COR |
|------|----------------------|
| 2908 | preto |
| 2909 | branco |
| 2910 | dourado lixado |
| 2911 | preto/dourado lixado |
| 2912 | preto/cobre lixado |



860/1 – luminária de mesa foco

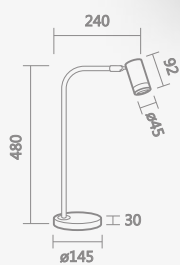

• 1 spot MR11 – 1 x GU10

| ID | COR |
|------|----------------------|
| 2884 | preto |
| 2885 | preto/cobre lixado |
| 2887 | preto/dourado lixado |



861/1 – coluna foco

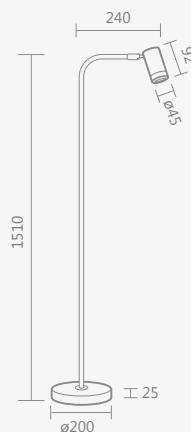

• 1 spot MR11 – 1 x GU10

| ID | COR |
|------|----------------------|
| 2916 | preto |
| 2917 | preto/cobre lixado |
| 2918 | preto/dourado lixado |

linha hight

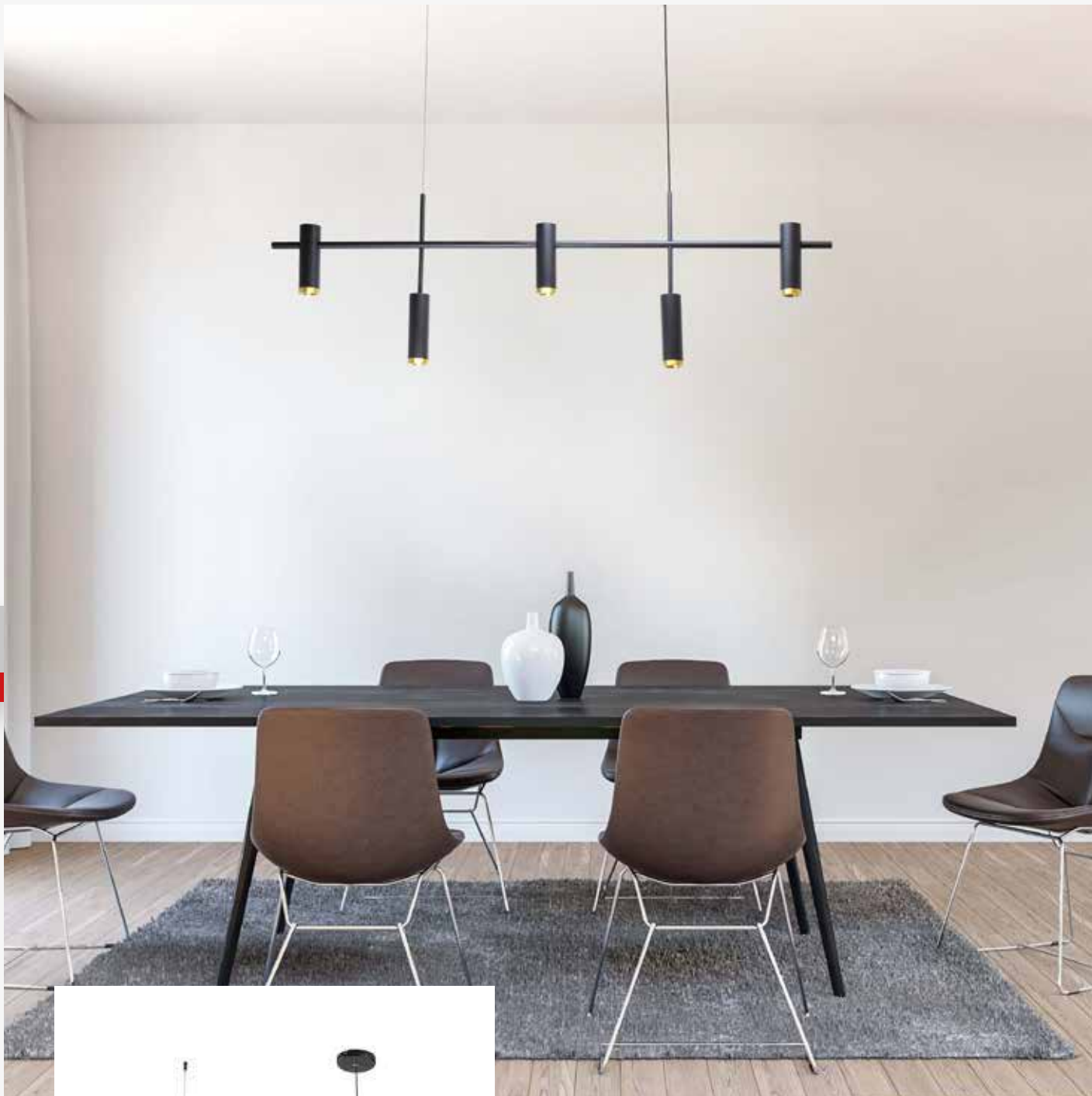

27



1010/5 – pendente hight

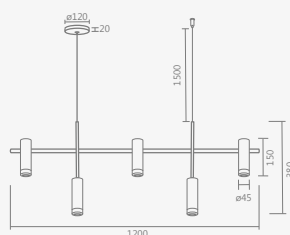

• 5 spot MR11 – 5 x GU10

| ID | COR |
|------|----------------------|
| 4587 | dourado ono |
| 4588 | preto/dourado lixado |
| 4589 | preto |
| 4590 | branco |
| 4591 | preto/cobre lixado |

linha cordoba



28

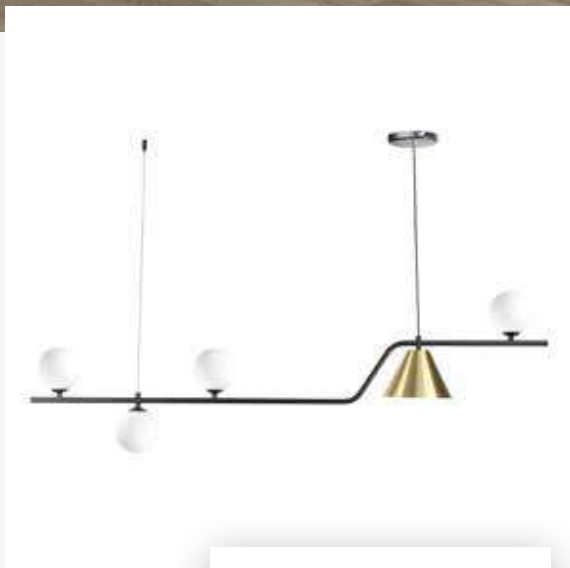

1011/5 – pendente cordoba

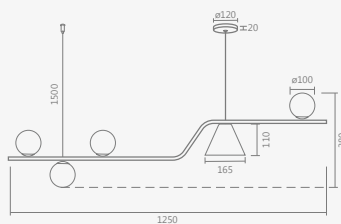

- 4 globos vidro leitoso $\varnothing 100\text{mm}$ – 4 x G9
- 1 cúpula – 1 x G9

| ID | COR |
|------|----------------------|
| 4592 | preto/dourado lixado |
| 4593 | preto |
| 4594 | branco |
| 4595 | preto/cobre lixado |
| 4596 | dourado ono |

linha thin

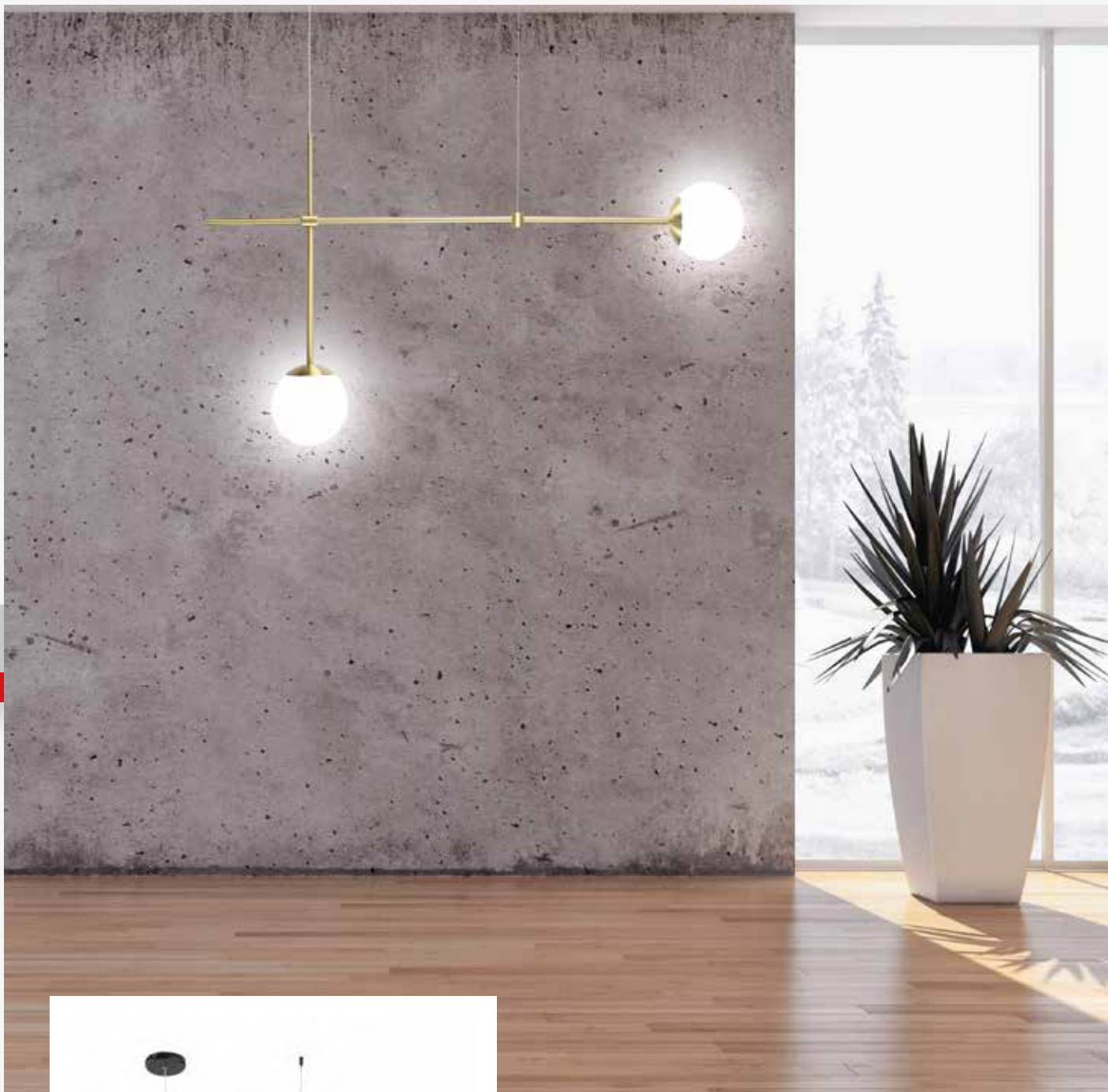

29

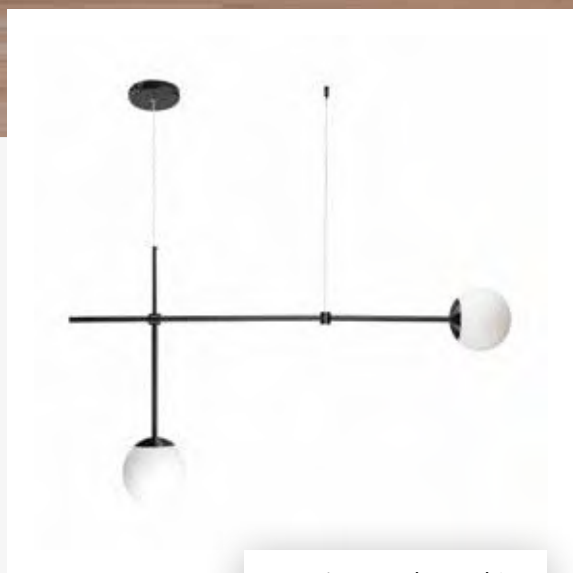

1022/2 – pendente thin

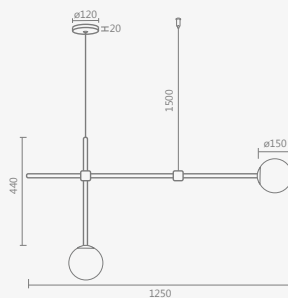

• 2 globos vidro leitoso $\varnothing 150\text{mm}$ – 2 x E27

| ID | COR |
|------|-----------------------|
| 4522 | branco/dourado lixado |
| 4523 | preto |
| 4524 | dourado polido |
| 4525 | dourado onó |
| 4526 | preto/dourado lixado |

linha twist

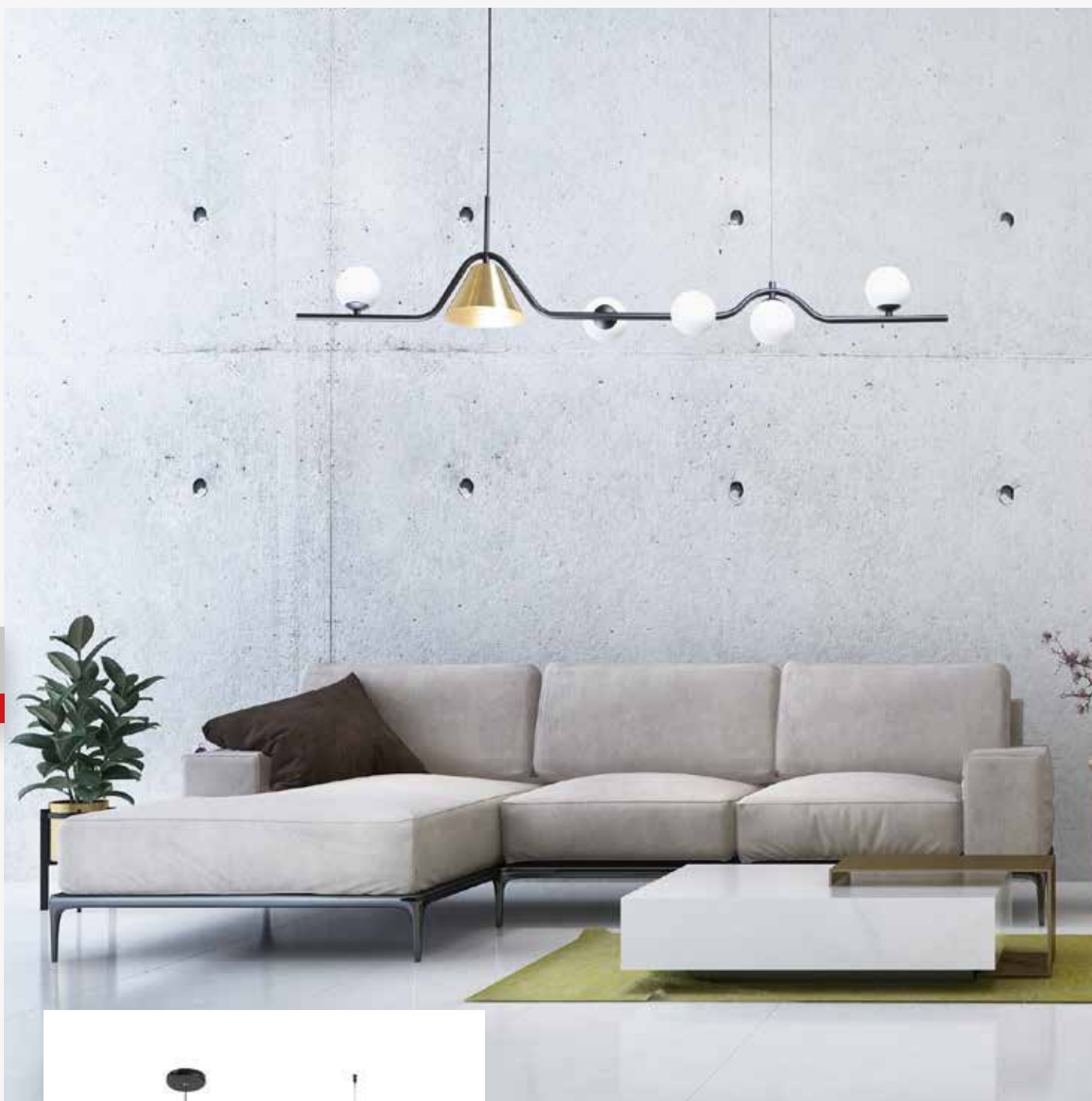

1023/6 – pendente twist

- 5 globos vidro leitoso $\varnothing 100\text{mm}$ – 5 x G9
- 1 cúpula – 1 x G9

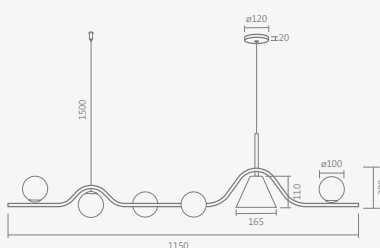

| ID | COR |
|------|-----------------------|
| 4527 | preto/dourado lixado |
| 4528 | preto |
| 4529 | branco |
| 4530 | preto/cobre lixado |
| 4531 | dourado onô |
| 4532 | branco/dourado lixado |



linha corner



997/1 – arandela corner

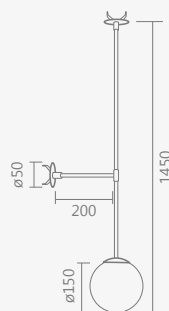

- 1 globo vidro leitoso ϕ 150mm – 1 x E27

| ID | COR |
|------|----------------|
| 4601 | branco |
| 4602 | preto |
| 4605 | dourado polido |
| 4607 | dourado ono |
| 4610 | dourado lixado |
| 4611 | cobre lixado |

linha blown



32



1018/1 – pendente blown



880/1 – pendente blown para gesso

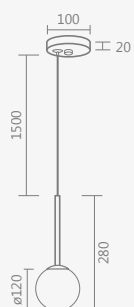

- 1 globo vidro leitoso $\varnothing 120\text{mm}$ – 1 x G9

| ID | COR |
|------|----------------|
| 4207 | dourado lixado |
| 4426 | dourado ono |
| 4430 | preto |
| 4431 | branco |
| 4432 | cobre lixado |
| 4433 | dourado polido |

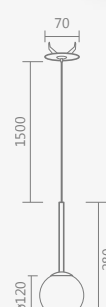

- 1 globo vidro leitoso $\varnothing 120\text{mm}$ – 1 x G9

| ID | COR |
|------|----------------|
| 4162 | dourado lixado |
| 4164 | dourado ono |
| 4165 | preto |
| 4167 | branco |
| 4168 | cobre lixado |
| 4425 | dourado polido |



linha vенеza

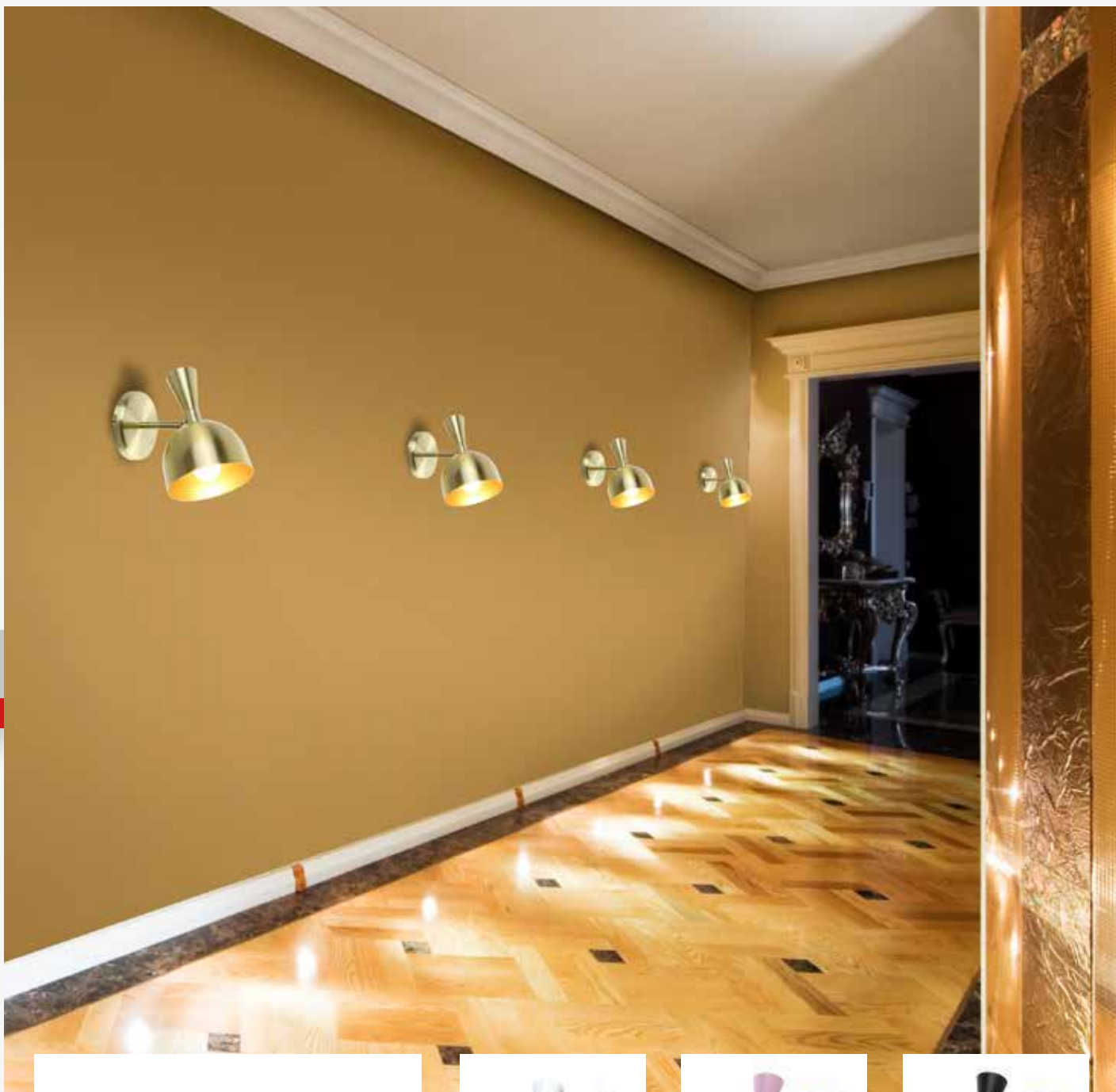

33



878/1 – arandela veneza

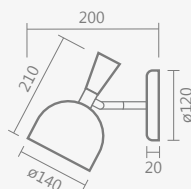

• 1 soquete E27

| ID | COR |
|------|-----------------------|
| 4141 | rosa/dourado lixado |
| 4145 | preto |
| 4147 | branco/dourado lixado |
| 4148 | dourado lixado |
| 4149 | preto/dourado lixado |
| 4150 | dourado ono |

linha parma

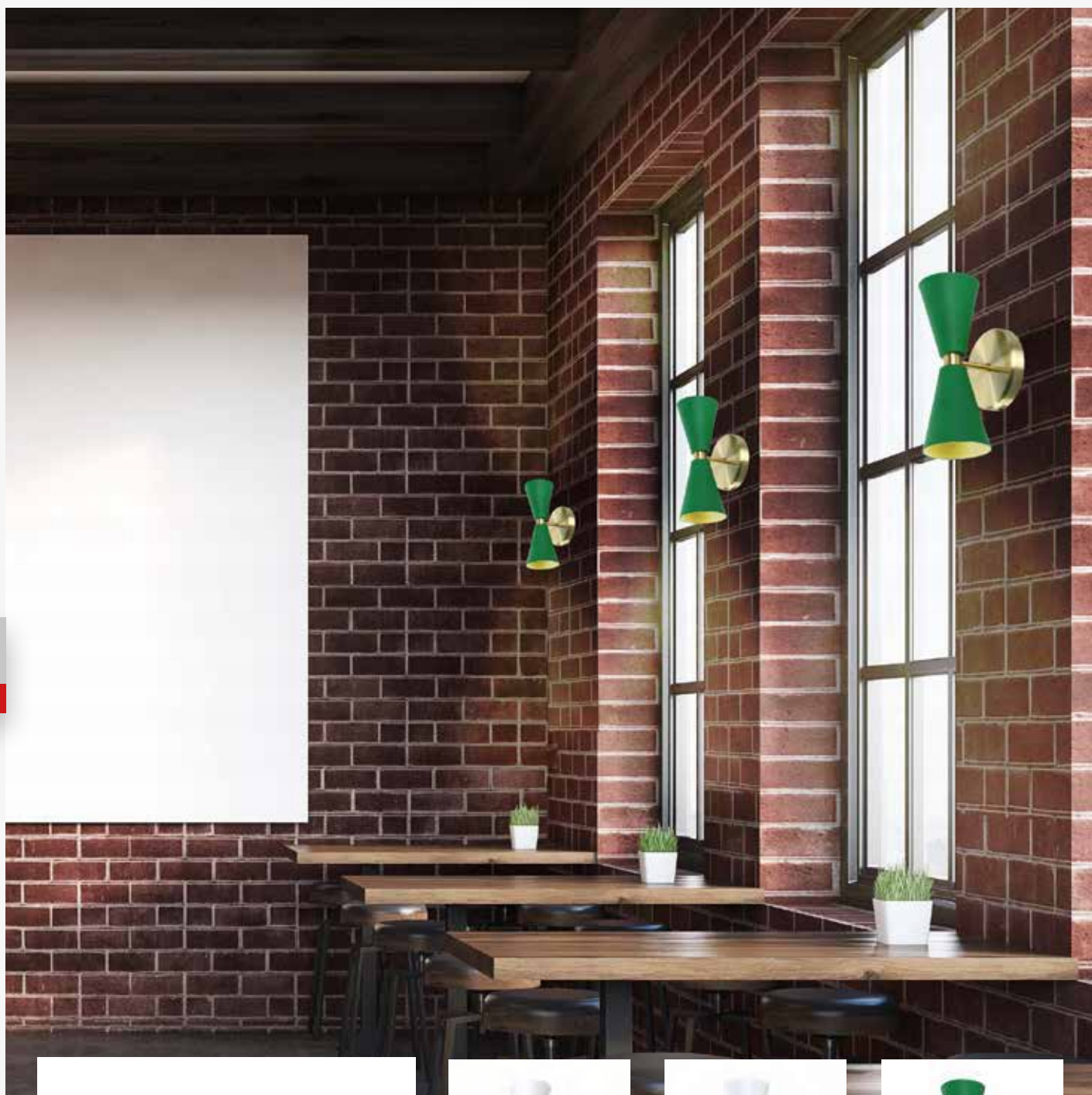

886/2 – arandela parma

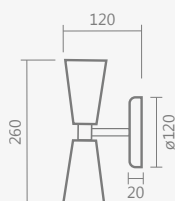
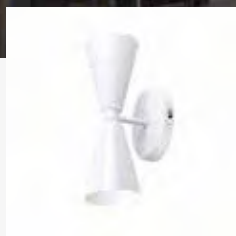

• 2 soquetes GU10

| ID | COR |
|------|-----------------------|
| 4222 | preto/dourado lixado |
| 4223 | preto |
| 4224 | branco |
| 4225 | branco/dourado lixado |
| 4226 | verde/dourado lixado |
| 4429 | dourado ono |
| 4683 | dourado lixado |

linha novara



890/1 – arandela novara

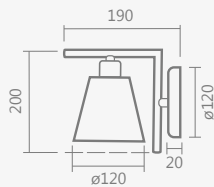

- 1 soquete E27

| ID | COR | CÚPULA |
|------|----------------|--------|
| 4250 | preto | preta |
| 4251 | branco | cru |
| 4253 | dourado polido | preta |
| 4256 | dourado ono | preta |
| 4438 | dourado polido | cru |
| 4439 | dourado ono | cru |



linha torcia



885/1 – arandela torcia

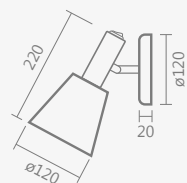

botão
liga/desliga
na peça

- 1 soquete E27

| ID | COR | CÚPULA |
|------|----------------------|--------|
| 4218 | preto/dourado lixado | preta |
| 4219 | preto | preta |
| 4220 | dourado lixado | cru |
| 4221 | branco | cru |
| 4427 | dourado ono | preta |
| 4428 | dourado ono | cru |



linha string



887/1 – arandela string

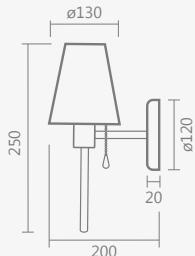

cordão
liga/desliga
na peça

- 1 soquete E27

| ID | COR | CÚPULA |
|------|----------------|--------|
| 4229 | preto | preta |
| 4230 | dourado lixado | preta |
| 4231 | dourado ono | preta |
| 4232 | branco | cru |
| 4233 | dourado lixado | cru |



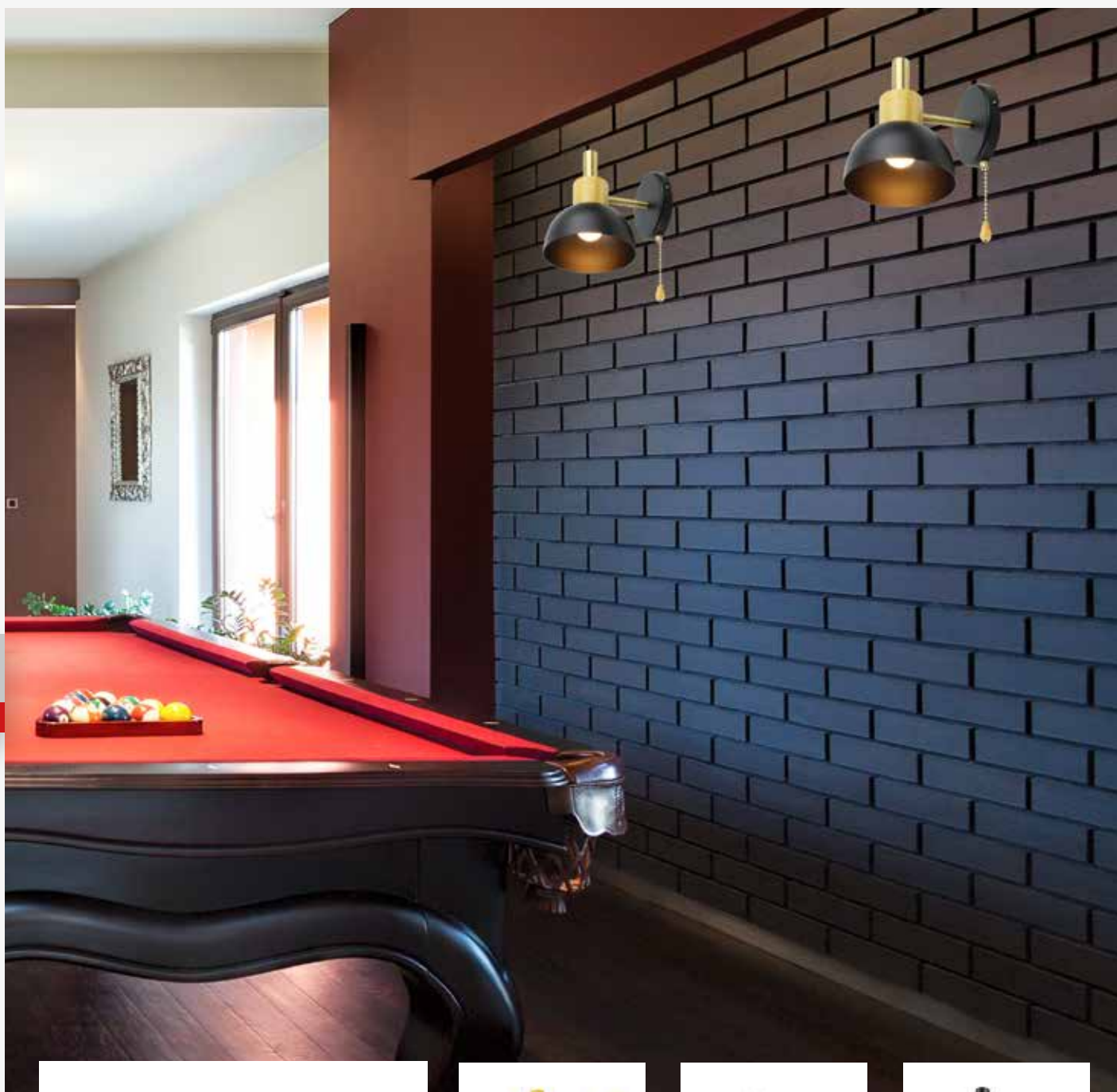

896/1 – arandela ipê



cordão
liga/desliga
na peça

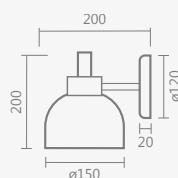

• 1 soquete E27

| ID | COR |
|------|----------------------|
| 4151 | preto |
| 4156 | amarelo |
| 4158 | branco |
| 4161 | preto/dourado lixado |
| 4163 | dourado lixado |

linha stelo



37



1039/1 – arandela stelo

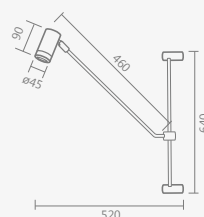

• 1 spot MR11 – 1 x GU10

| ID | COR |
|------|----------------------|
| 4743 | branco |
| 4744 | preto |
| 4745 | dourado ono |
| 4746 | cobre ono |
| 4747 | preto/dourado lixado |

linha esteca



1040/1 – arandela esteca

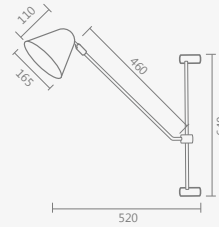

- 1 soquete E27

| ID | COR |
|------|-----------------------|
| 4752 | preto/dourado lixado |
| 4748 | branco |
| 4749 | preto |
| 4750 | dourado ono |
| 4751 | cobre ono |
| 4868 | branco/dourado lixado |



38

linha lina



883/1 – arandela lina

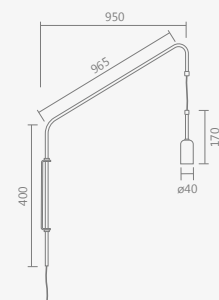

- 1 soquete E27

| ID | COR |
|------|----------------------|
| 4206 | preto/dourado lixado |
| 4208 | preto |
| 4209 | dourado ono |

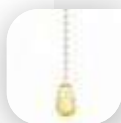
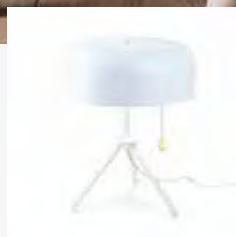

cordão
liga/desliga
na peça

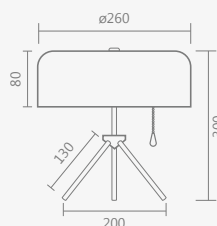

- 10 watts – bivolt
- 750 lumens

| ID | COR | COR LED |
|------|----------------------|---------|
| 4166 | rosa/verde | 3000K |
| 4171 | branco | |
| 4173 | preto/dourado lixado | |
| 4176 | dourado lixado | |
| 4718 | preto | |

895/1 – luminária de mesa volare

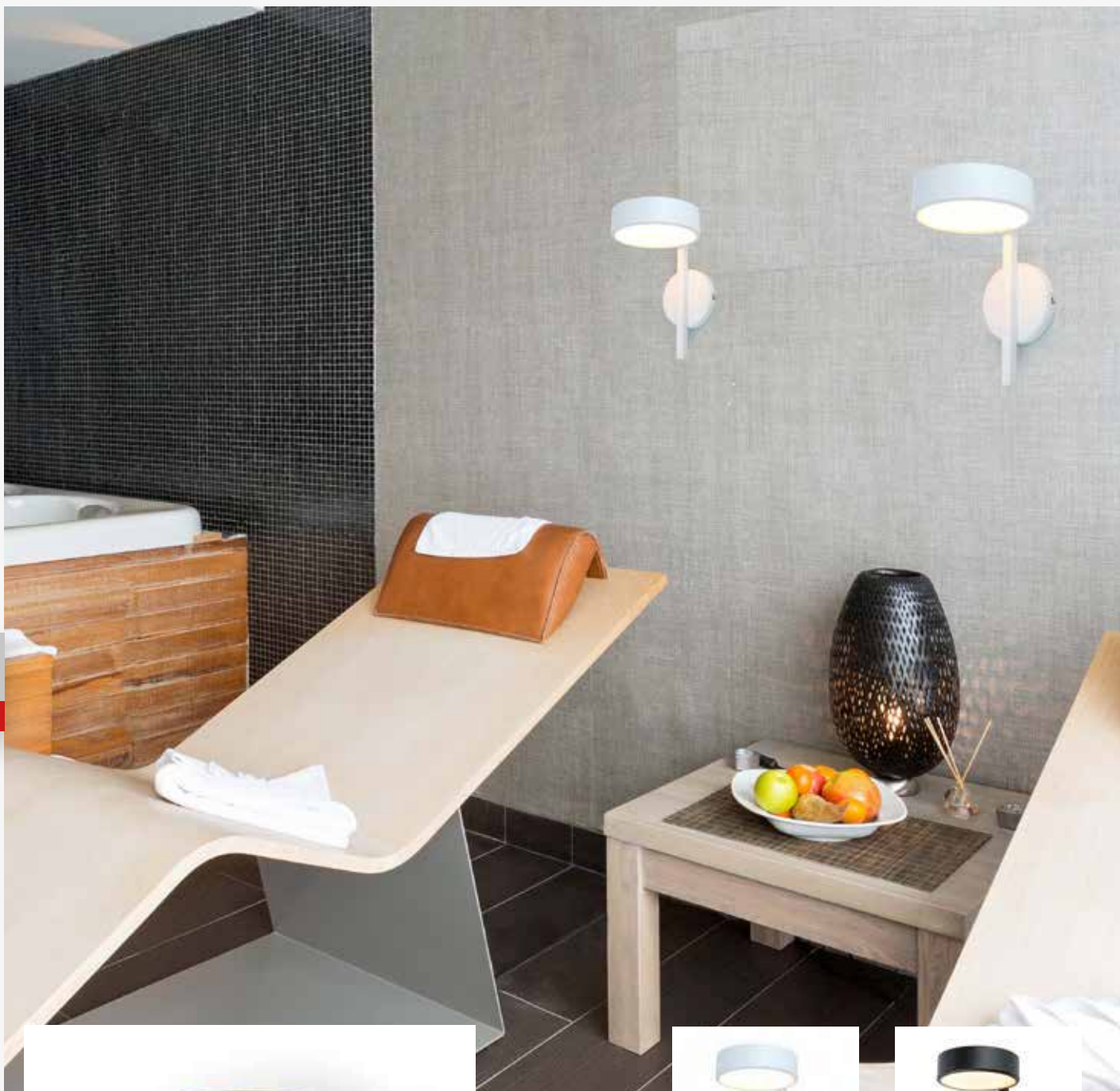

884/1 – arandela cake

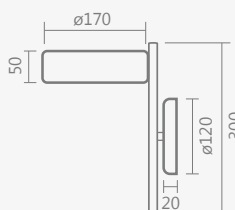

- 8 watts – bivolt
- 600 lumens

| ID | COR | COR LED |
|------|-------------------|---------|
| 4210 | preto/dourado ono | 3000K |
| 4211 | preto | |
| 4212 | branco | |
| 4213 | dourado ono | |
| 4214 | preto/dourado ono | 4000K |
| 4215 | preto | |
| 4216 | branco | |
| 4217 | dourado ono | |



847/1 – abajur cake

- 8 watts – bivolt
- 600 lumens

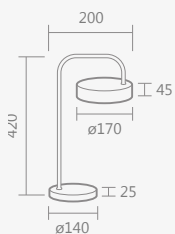

| ID | COR | COR LED |
|------|----------------------|---------|
| 2939 | preto/dourado lixado | 3000K |
| 2940 | preto | |
| 2941 | preto/cobre lixado | |
| 2942 | dourado ono | |
| 2943 | cobre ono | |
| 2934 | preto/dourado lixado | 4000K |
| 2935 | preto | |
| 2936 | preto/cobre lixado | |
| 2937 | dourado ono | |
| 2938 | cobre ono | |



850/1 – coluna cake

- 13 watts – bivolt
- 975 lumens

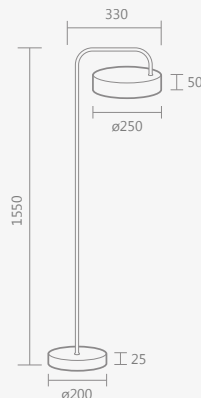

| ID | COR | COR LED |
|------|----------------------|---------|
| 2874 | preto/dourado lixado | 3000K |
| 2876 | preto | |
| 2877 | preto/cobre lixado | |
| 2878 | dourado ono | |
| 2879 | cobre ono | |
| 2946 | preto/dourado lixado | 4000K |
| 2947 | preto | |
| 2948 | preto/cobre lixado | |
| 2949 | dourado ono | |
| 2950 | cobre ono | |

linha pipe



893/1 – luminária de mesa pipe



894/1 – coluna pipe

• 1 soquete E27

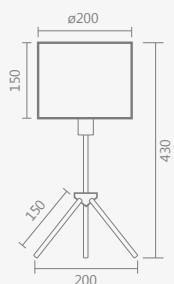

| ID | COR | CÚPULA |
|------|-----------------------|--------|
| 4269 | branco | cru |
| 4270 | dourado polido | |
| 4271 | dourado lixado/branco | |
| 4274 | dourado lixado | |
| 4309 | branco/dourado polido | preta |
| 4301 | branco/dourado polido | |
| 4302 | preto/dourado polido | |
| 4303 | preto | |
| 4304 | branco | |
| 4305 | dourado polido | |
| 4306 | dourado ono | |
| 4307 | preto/dourado lixado | |
| 4308 | dourado lixado | |

• 1 soquete E27

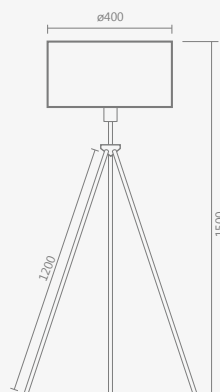

| ID | COR | CÚPULA |
|------|----------------|--------|
| 4144 | branco | cru |
| 4146 | dourado polido | |
| 4257 | dourado polido | preta |
| 4261 | preto | |
| 4266 | dourado ono | |

linha imola



891/1 – luminária de mesa imola

- 1 globo vidro leitoso $\phi 100\text{mm}$ – 1 x G9

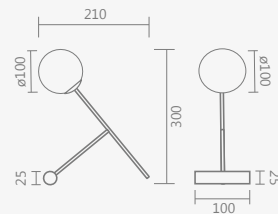

| ID | COR |
|------|----------------|
| 4291 | dourado ono |
| 4292 | preto |
| 4293 | dourado polido |
| 4294 | branco |



43

linha malta



991/1 – luminária de mesa malta

- 1 soquete E27

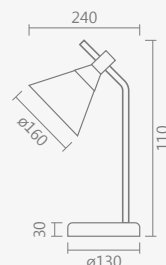

| ID | COR |
|------|-----------------------|
| 4910 | rosa/dourado lixado |
| 4909 | branco/dourado lixado |
| 4262 | preto/dourado lixado |
| 4263 | preto |
| 4265 | dourado ono |
| 4440 | azul claro |
| 4881 | dourado lixado/branco |
| 4829 | cobre ono |

linha iglu



892/1 – luminária de mesa iglu

• 1 soquete E27

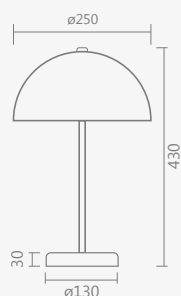

| ID | COR |
|------|-----------------------|
| 4039 | branco/dourado lixado |
| 4295 | dourado lixado/branco |
| 4296 | dourado lixado/preto |
| 4297 | preto |
| 4298 | branco |
| 4299 | dourado lixado |
| 4300 | dourado onô |
| 4310 | cobre lixado/branco |
| 4311 | cobre lixado/preto |



linha maia



897/1 – luminária de mesa maia

• 1 soquete G9

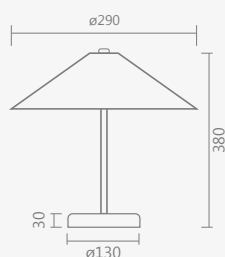

| ID | COR |
|------|-----------------------|
| 4170 | dourado lixado/branco |
| 4181 | dourado lixado/preto |
| 4183 | preto |
| 4189 | branco |
| 4190 | dourado lixado |
| 4191 | dourado onô |

linha atena



45

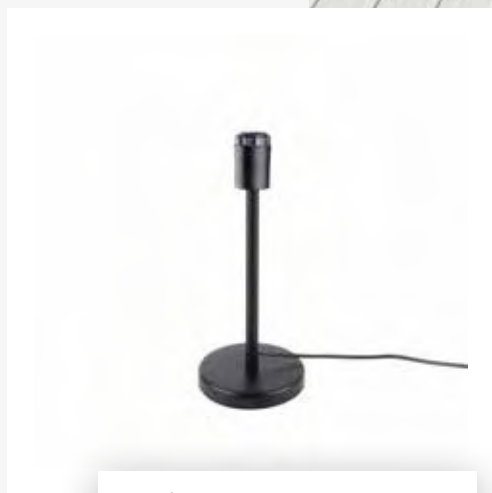

989/1 – luminária de mesa atena



990/1 – coluna de chão atena

• 1 soquete E27

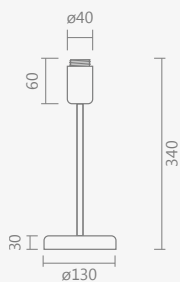

| ID | COR |
|------|----------------|
| 4198 | dourado lixado |
| 4227 | preto |
| 4228 | branco |
| 4240 | dourado ono |

• 1 soquete E27



| ID | COR |
|------|----------------|
| 4243 | dourado lixado |
| 4249 | preto |
| 4252 | branco |
| 4255 | dourado ono |



linha savana



882/1 – pendente savana



• 1 soquete E27

| ID | COR |
|------|----------------|
| 4182 | branco |
| 4200 | preto |
| 4201 | dourado lixado |
| 4202 | dourado onô |
| 4203 | preto/azul |
| 4204 | amarelo/marrom |
| 4205 | rosa/verde |

linha carpi



888/1 – pendente carpi

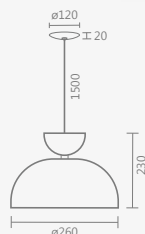

• 1 soquete E27

| ID | COR |
|------|----------------|
| 4234 | branco |
| 4235 | preto |
| 4237 | dourado lixado |
| 4238 | dourado onô |
| 4239 | preto/azul |
| 4241 | amarelo/marrom |
| 4242 | rosa/verde |



linha draft



879/1 – pendente draft

• 1 soquete E27

| ID | COR |
|------|----------------|
| 4152 | branco |
| 4153 | preto |
| 4154 | dourado lixado |
| 4155 | dourado onô |
| 4157 | preto/azul |
| 4159 | amarelo/marrom |
| 4160 | rosa/verde |

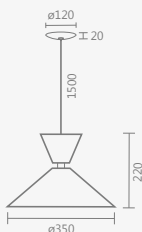

linha pisa

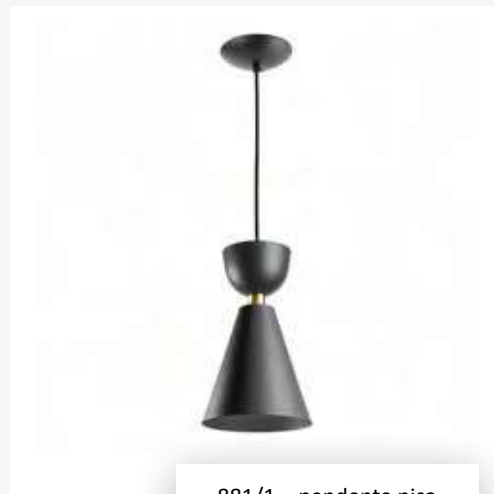

881/1 – pendente pisa

• 1 soquete E27

| ID | COR |
|------|----------------|
| 4172 | branco |
| 4174 | preto |
| 4175 | dourado lixado |
| 4177 | dourado onô |
| 4178 | preto/azul |
| 4179 | amarelo/marrom |
| 4180 | rosa/verde |

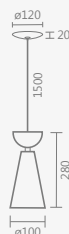

linha mônaco



992/1 – luminária de mesa mônaco

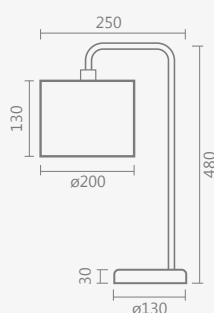

• 1 soquete E27

| ID | COR | CÚPULA |
|------|-----------------------|--------|
| 4275 | branco/dourado lixado | cru |
| 4268 | preto/dourado lixado | |
| 4272 | preto | preta |
| 4273 | dourado ono | |



linha grécia



988/1 – luminária de mesa grécia

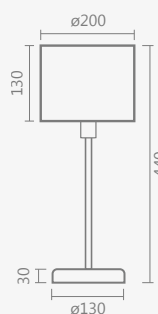

• 1 soquete E27

| ID | COR | CÚPULA |
|------|----------------|--------|
| 4192 | dourado lixado | cru |
| 4195 | branco | |
| 4197 | dourado ono | preta |
| 4193 | dourado lixado | |
| 4194 | preto | |
| 4196 | dourado ono | |

linha frame



1029/1 – luminária de mesa frame



1038/1 – luminária de mesa frame

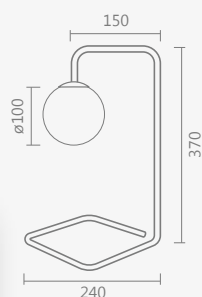

- 1 globo vidro leitoso \varnothing 100mm – 1 x G9

| ID | COR |
|------|-------------|
| 4569 | branco |
| 4570 | preto |
| 4571 | rosa |
| 4572 | dourado ono |
| 4573 | azul claro |

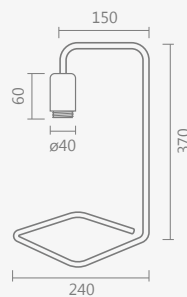

- 1 soquete E27

| ID | COR |
|------|-------------|
| 4574 | branco |
| 4575 | preto |
| 4576 | rosa |
| 4577 | dourado ono |
| 4578 | azul claro |



1000/1 – luminária de mesa frame



1001/1 – luminária de mesa frame

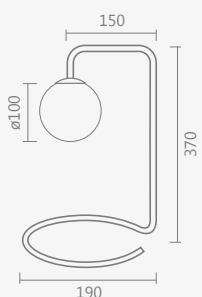

- 1 globo vidro leitoso \varnothing 100mm – 1 x G9

| ID | COR |
|------|-------------|
| 4632 | branco |
| 4633 | preto |
| 4634 | rosa |
| 4635 | dourado ono |
| 4636 | azul claro |

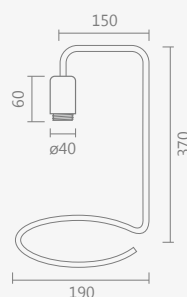

- 1 soquete E27

| ID | COR |
|------|-------------|
| 4637 | branco |
| 4638 | preto |
| 4639 | rosa |
| 4640 | dourado ono |
| 4641 | azul claro |

linha soul



50



849/1 – pendente soul

• 1 soquete E27

| ID | COR |
|------|----------------------|
| 2853 | preto |
| 2854 | dourado lixado |
| 2855 | preto/dourado lixado |
| 2856 | preto/cobre lixado |
| 4323 | branco |



854/1 – coluna soul

• 1 soquete E27

| ID | COR |
|------|----------------------|
| 2857 | preto |
| 2858 | dourado lixado |
| 2859 | preto/dourado lixado |
| 2860 | preto/cobre lixado |

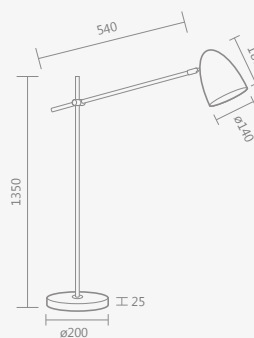
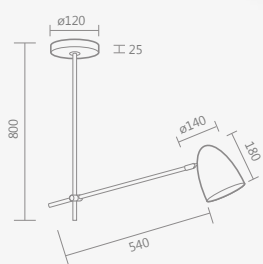

linha hook



51

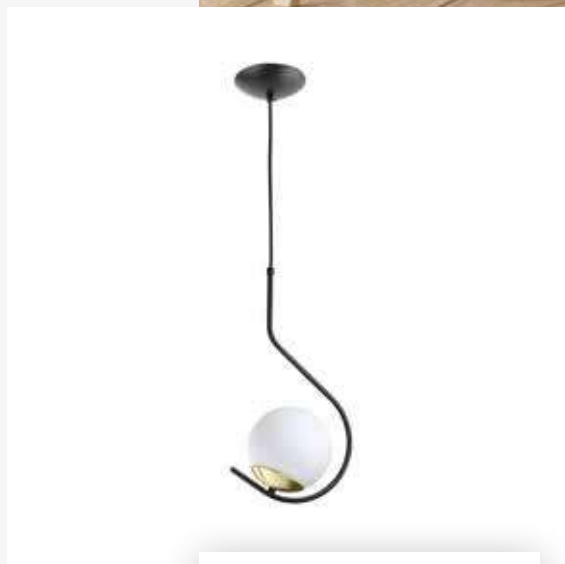

851/1 – pendente hook

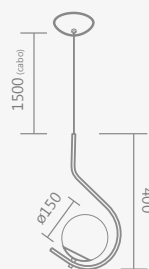

• 1 globo vidro Ø150mm – 1 x E27

| ID | COR |
|------|----------------------|
| 2861 | preto/dourado lixado |
| 2862 | preto/cobre lixado |
| 2863 | preto |
| 2864 | dourado onô |
| 2865 | cobre onô |
| 2866 | dourado polido |
| 2867 | cobre polido |

linha unique

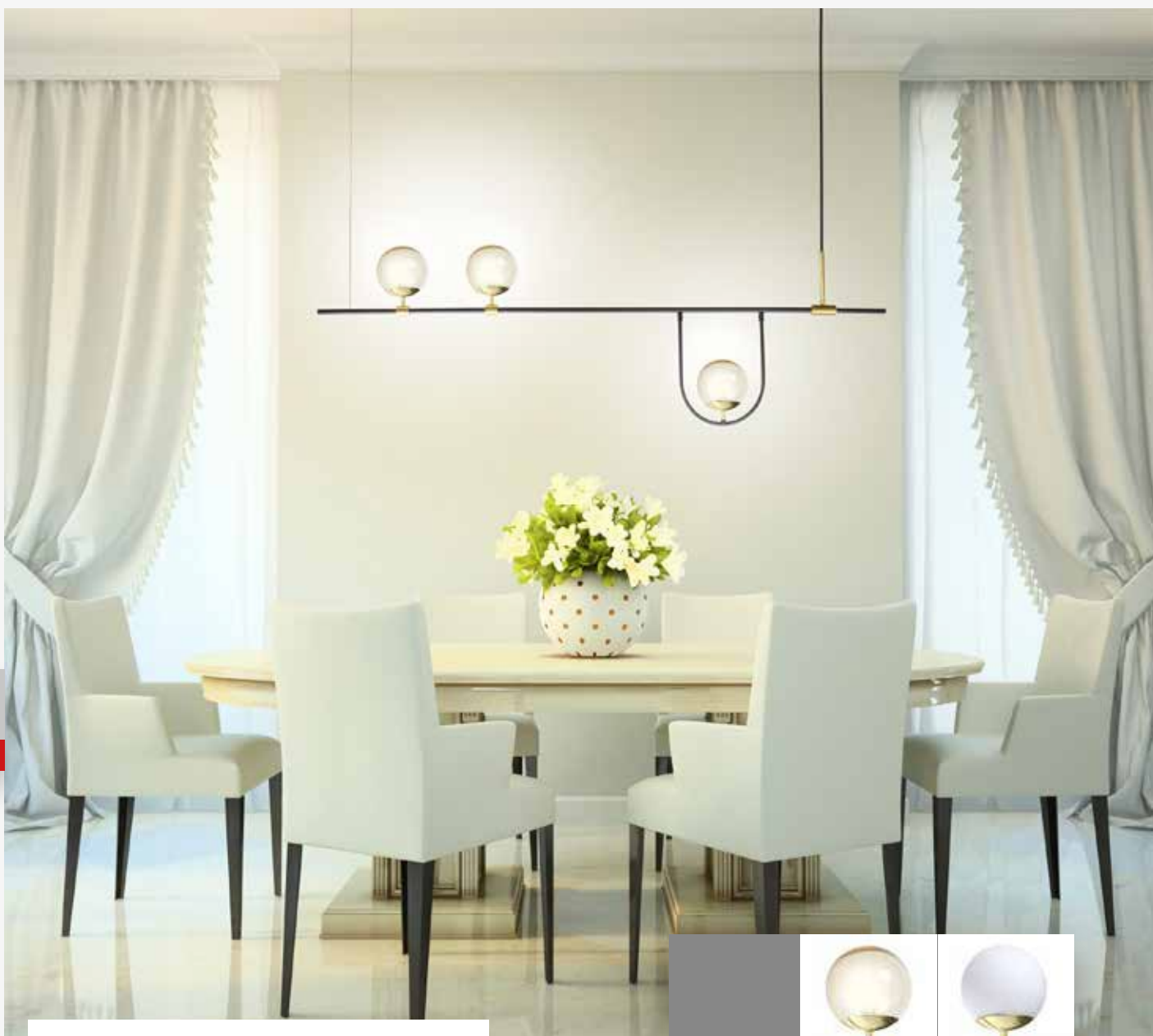

52



3 X G9

ambar

leitoso



859/3 – pendente unique

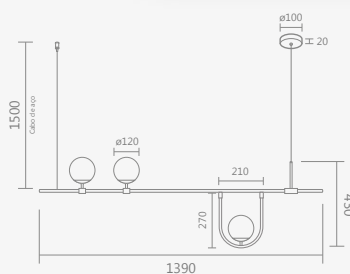

• 3 globos vidro \varnothing 120mm – 3 x G9

| globo ambar | |
|-------------|-----------------------|
| ID | COR |
| 3059 | preto/cobre lixado |
| 4728 | branco |
| 4729 | branco/dourado lixado |
| 4730 | branco/cobre lixado |
| 3057 | preto |
| 3058 | preto/dourado lixado |

| globo leitoso | |
|---------------|-----------------------|
| ID | COR |
| 2913 | preto |
| 2914 | preto/dourado lixado |
| 2915 | preto/cobre lixado |
| 3977 | branco/cobre lixado |
| 4321 | branco/dourado lixado |

linha cruze



53



4 X G9

ambar

leitoso



867/4 – pendente cruze

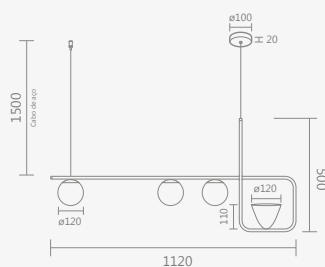

- 3 globos vidro ø120mm – 3 x G9
- 1 cúpula – 1 x G9

| globo ambar | |
|-------------|----------------------|
| ID | COR |
| 3026 | preto |
| 3027 | preto/dourado lixado |
| 3028 | preto/cobre lixado |

| globo leitoso | |
|---------------|----------------------|
| ID | COR |
| 2961 | preto |
| 2962 | preto/dourado lixado |
| 2963 | preto/cobre lixado |



862/1 – abajur zurick



863/1 – arandela zurick

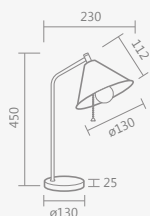

• 1 soquete E27

| ID | COR |
|------|----------------------|
| 2923 | preto |
| 2924 | preto/cobre lixado |
| 2925 | preto/dourado lixado |

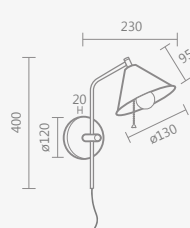

• 1 soquete E27

| ID | COR |
|------|----------------------|
| 2894 | preto |
| 2895 | preto/cobre lixado |
| 2898 | preto/dourado lixado |

linha power



845/1 – pendente power

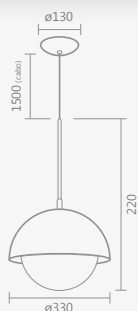

- 1 soquete E27

| ID | COR |
|------|----------------|
| 2845 | dourado lixado |
| 2846 | cobre lixado |
| 2847 | dourado ono |
| 2848 | preto |
| 4882 | branco |



848/1 – abajur power



- 1 soquete E27

| ID | COR |
|------|----------------|
| 2919 | dourado lixado |
| 2920 | cobre lixado |
| 2921 | dourado ono |
| 2922 | preto |
| 4395 | branco |



853/1 – coluna power

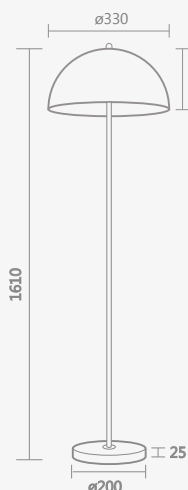

- 1 soquete E27

| ID | COR |
|------|----------------|
| 2849 | dourado lixado |
| 2850 | cobre lixado |
| 2851 | dourado ono |
| 2852 | preto |
| 4719 | branco |

linha shine



56



852/1 – arandela shine

- 2 watts – bivolt
- 112,5 lumens

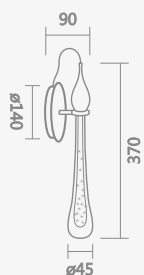

| ID | COR | COR LED |
|------|----------------|---------|
| 2868 | preto | 3000K |
| 2870 | dourado polido | |
| 2871 | cobre polido | |
| 2872 | dourado lixado | |
| 2873 | cobre lixado | |
| 4519 | dourado ono | |
| 4917 | cobre ono | |
| 4918 | lixado | |
| 4919 | polido | |



832/1 – pendente shine

- 2 watts – bivolt
- 150 lumens

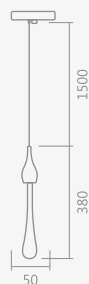

| ID | COR | COR LED |
|------|----------------|---------|
| 1475 | cobre lixado | 3000K |
| 1476 | dourado lixado | |
| 1478 | cobre ono | |
| 1479 | cobre polido | |
| 1480 | dourado ono | |
| 1481 | dourado polido | |
| 1482 | preto | |
| 2825 | lixado | |
| 4389 | polido | |

linha alamo



864/2 – arandela alamo

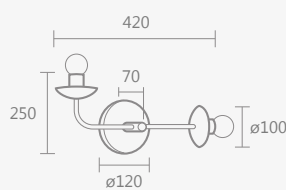

• 2 soquetes E27

| ID | COR |
|------|----------------------|
| 2889 | preto |
| 2891 | preto/cobre lixado |
| 2892 | preto/dourado lixado |

linha summer



58

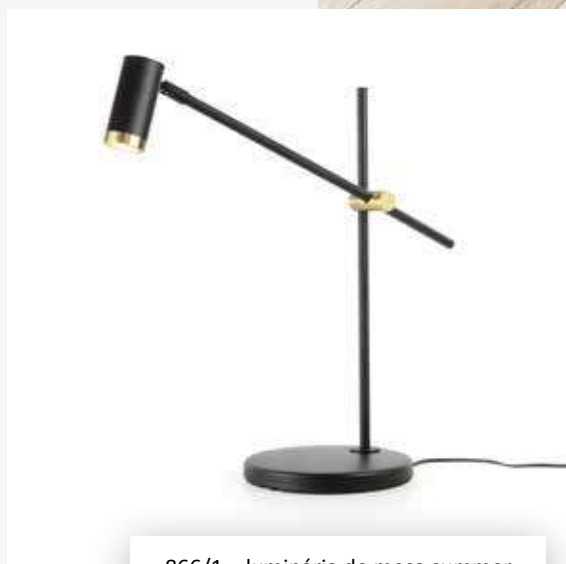

866/1 – luminária de mesa summer

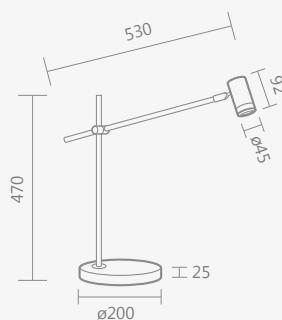

• 1 spot MR11 - 1 x GU10

| ID | COR |
|------|----------------------|
| 2958 | preto |
| 2959 | preto/cobre lixado |
| 2960 | preto/dourado lixado |

linha grau

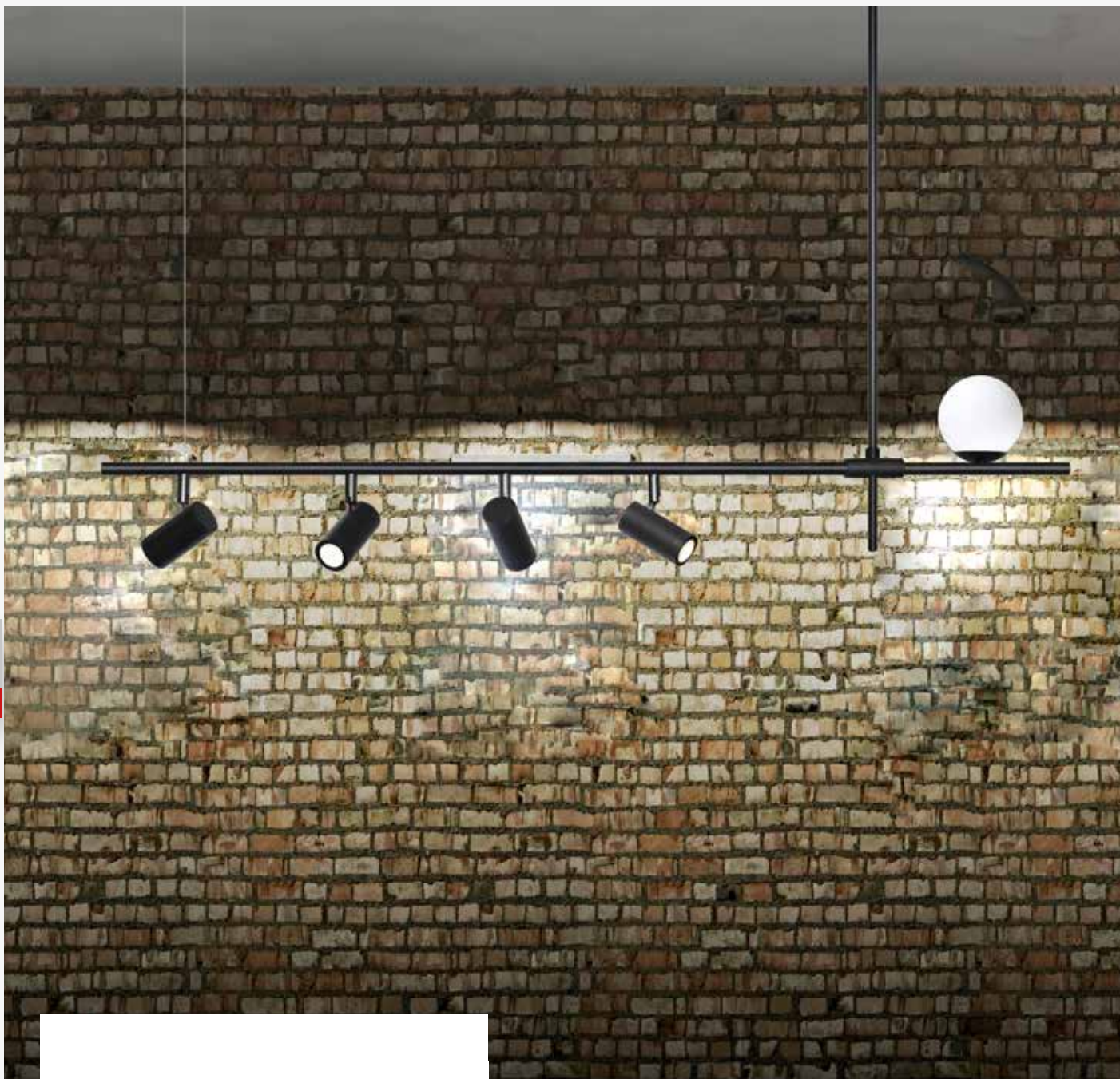

59

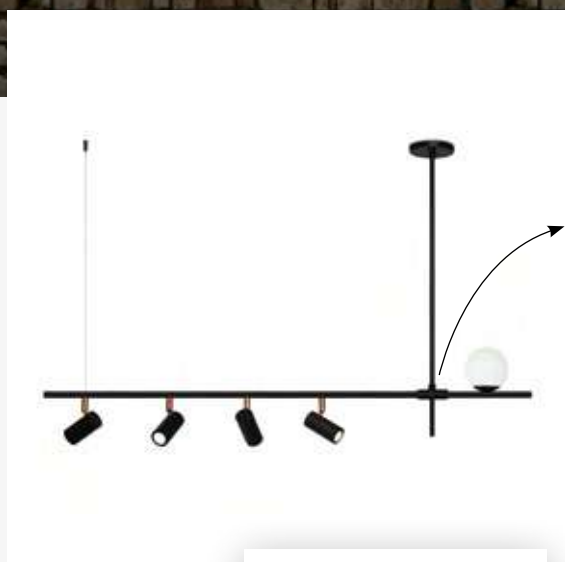

808/5 – pendente grau

articulada 360°



- 1 globo vidro leitoso Ø120mm – 1 x G9
- 4 spots MR11 – 4 x GU10

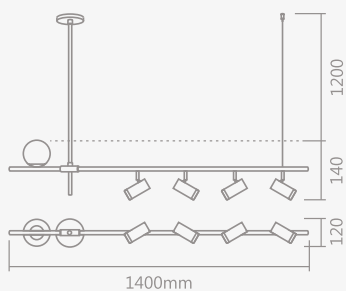

| ID | COR |
|------|----------------------|
| 1311 | cobre lixado |
| 1312 | cobre onô |
| 1313 | cobre polido |
| 1314 | dourado lixado |
| 1315 | dourado onô |
| 1316 | dourado polido |
| 1317 | preto |
| 1318 | preto/cobre lixado |
| 1319 | preto/cobre onô |
| 1320 | preto/cobre polido |
| 1321 | preto/dourado lixado |
| 1322 | preto/dourado onô |
| 1323 | preto/dourado polido |

linha honda



60



807/4 – pendente honda

articulada 360°

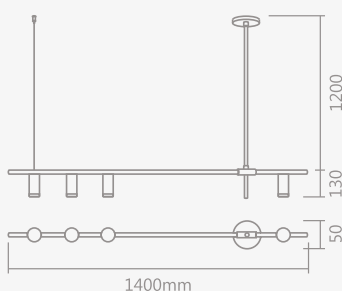

• 4 spots MR11 – 4 x GU10

| ID | COR |
|------|----------------------|
| 1299 | dourado ono |
| 1301 | preto |
| 1302 | preto/cobre lixado |
| 1303 | preto/cobre polido |
| 1304 | preto/dourado lixado |
| 1305 | preto/dourado ono |
| 1306 | dourado polido |
| 1307 | dourado lixado |
| 1944 | cobre lixado |
| 3866 | cobre ono |

linha ávila



61



articulada 360°



- 3 globos vidro leitoso Ø120mm – 1 x G9
- 1 cúpula – 1 x G9

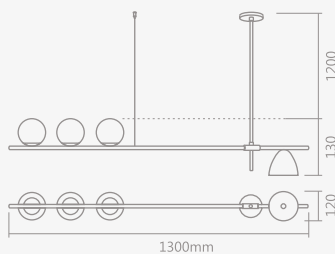

| ID | COR |
|------|----------------------|
| 1267 | preto |
| 1268 | preto/cobre lixado |
| 1269 | preto/cobre polido |
| 1270 | preto/dourado lixado |
| 1271 | preto/dourado onô |
| 1272 | preto/dourado polido |
| 2163 | preto/cobre onô |
| 2176 | dourado lixado |

805/4 – pendente ávila

linha hills



806/3 – pendente hills

• 3 globos vidro leitoso \varnothing 120mm – 3 x G9

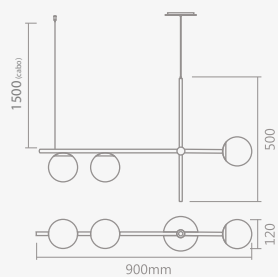

| ID | COR |
|------|----------------|
| 1273 | dourado ono |
| 1275 | cobre polido |
| 1276 | dourado lixado |
| 1277 | dourado polido |
| 1278 | lixado |
| 1279 | polido |
| 1280 | preto |
| 1281 | cobre lixado |
| 1926 | cobre ono |

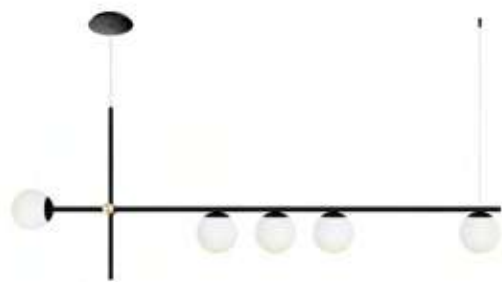

806/5 – pendente hills

• 5 globos vidro leitoso \varnothing 120mm – 5 x G9

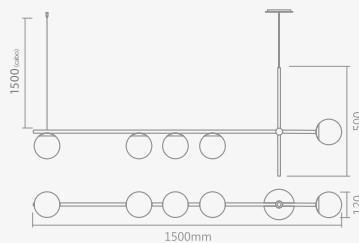

| ID | COR |
|------|----------------|
| 1282 | dourado ono |
| 1286 | cobre polido |
| 1288 | dourado lixado |
| 1289 | dourado polido |
| 3255 | lixado |
| 2324 | polido |
| 1290 | preto |
| 1297 | cobre lixado |
| 1285 | cobre ono |

linha geminis



802/2 – pendente gemini

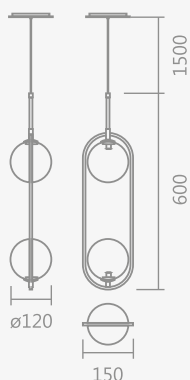

• 2 globos vidro \varnothing 120mm – 2 x G9

| globo ambar | | globo duo | |
|-------------|----------------|-----------|----------------|
| ID | COR | ID | COR |
| 1207 | cobre ono | 1217 | cobre ono |
| 1208 | cobre polido | 1218 | cobre polido |
| 1210 | dourado lixado | 1220 | dourado lixado |
| 1211 | dourado ono | 1221 | dourado ono |
| 1212 | dourado polido | 1222 | dourado polido |
| 1213 | preto | 1223 | preto |

linha madri



64



804/3 – pendente madri

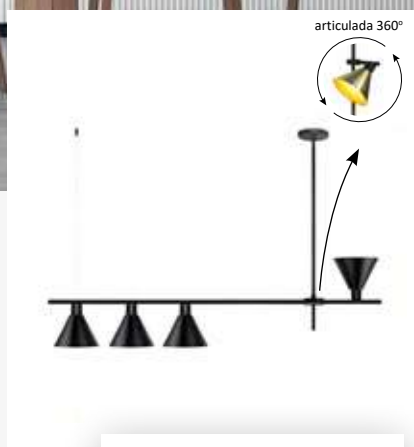

804/4 – pendente madri

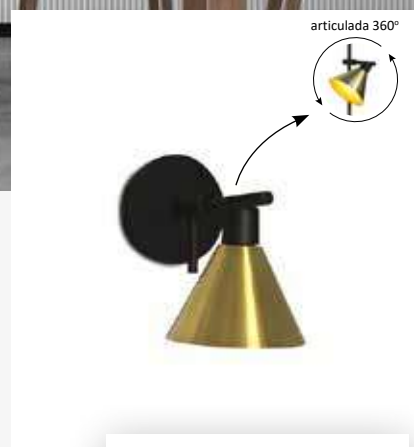

821/1 – arandela madri

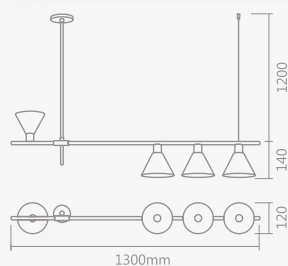
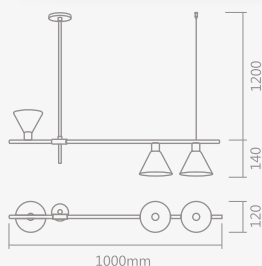

• 3 soquetes E27

| ID | COR |
|------|-----------------------|
| 1242 | branco |
| 1243 | cobre lixado |
| 1244 | cobre polido |
| 1245 | preto |
| 1246 | preto/cobre lixado |
| 1248 | preto/dourado polido |
| 1250 | dourado onô |
| 2118 | cobre onô |
| 2172 | preto/dourado lixado |
| 4921 | branco/cobre polido |
| 4922 | dourado polido |
| 4920 | branco/dourado lixado |
| 4924 | branco/cobre lixado |
| 1249 | rose |
| 4923 | branco/dourado polido |

• 4 soquetes E27

| ID | COR |
|------|-----------------------|
| 1250 | branco |
| 3727 | cobre lixado |
| 1252 | cobre polido |
| 1257 | preto |
| 1258 | preto/cobre lixado |
| 1262 | preto/dourado polido |
| 1255 | dourado onô |
| 1251 | cobre onô |
| 1260 | preto/dourado lixado |
| 3072 | branco/cobre polido |
| 4927 | dourado polido |
| 4926 | branco/dourado lixado |
| 4928 | branco/cobre lixado |
| 4929 | branco/cobre polido |
| 3124 | rose |

• 1 soquete E27

| ID | COR |
|------|-----------------------|
| 1418 | branco |
| 1902 | cobre lixado |
| 1410 | cobre polido |
| 1412 | preto |
| 1413 | preto/cobre lixado |
| 4925 | preto/dourado polido |
| 1411 | dourado onô |
| 1409 | cobre onô |
| 1415 | preto/dourado lixado |
| 4933 | branco/cobre polido |
| 2585 | dourado polido |
| 4934 | branco/dourado lixado |
| 4935 | branco/cobre lixado |
| 4936 | rose |
| 4937 | branco/dourado polido |

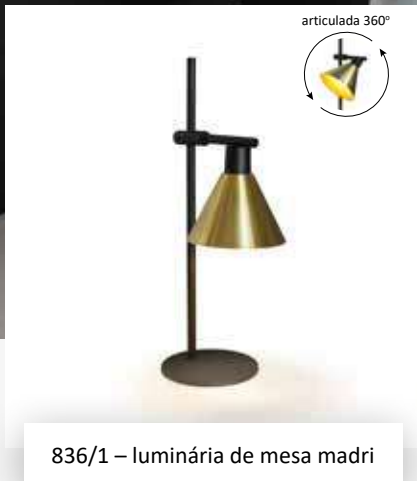

836/1 – luminária de mesa madri



• 1 soquete E27

| ID | COR |
|------|-----------------------|
| 1507 | branco |
| 4937 | cobre lixado |
| 1509 | cobre polido |
| 1511 | preto |
| 1505 | preto/cobre lixado |
| 4947 | preto/dourado polido |
| 1510 | dourado onô |
| 2195 | cobre onô |
| 1512 | preto/dourado lixado |
| 4940 | branco/cobre polido |
| 2145 | dourado polido |
| 4948 | branco/dourado lixado |
| 4949 | branco/cobre lixado |
| 1514 | rose |
| 1508 | branco/dourado polido |



804/1 – pendente madri

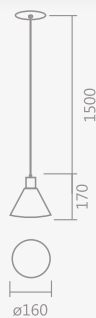

• 1 soquete E27

| ID | COR |
|------|-----------------------|
| 1236 | branco |
| 2968 | cobre lixado |
| 1237 | cobre polido |
| 1235 | preto |
| 1239 | preto/cobre lixado |
| 3046 | preto/dourado polido |
| 1851 | dourado onô |
| 3207 | cobre onô |
| 1884 | dourado lixado |
| 1240 | preto/dourado lixado |
| 4930 | branco/cobre polido |
| 1781 | dourado polido |
| 4931 | branco/dourado lixado |
| 4932 | branco/cobre lixado |
| 1241 | rose |

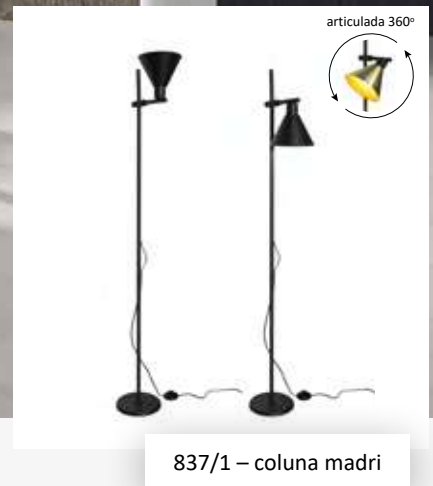

837/1 – coluna madri

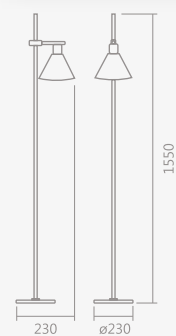

• 1 soquete E27

| ID | COR |
|------|-----------------------|
| 1522 | branco |
| 3666 | cobre lixado |
| 1523 | cobre polido |
| 1525 | preto |
| 1527 | preto/cobre lixado |
| 2073 | preto/dourado polido |
| 1862 | dourado onô |
| 4950 | cobre onô |
| 1530 | preto/dourado lixado |
| 2930 | branco/cobre polido |
| 4062 | dourado polido |
| 4951 | branco/dourado lixado |
| 4952 | branco/cobre lixado |
| 1532 | rose |
| 4953 | branco/dourado polido |

linha double



66



784/2 – pendente double

• 2 globos vidro leitoso $\varnothing 150\text{mm}$ – 2 x E27

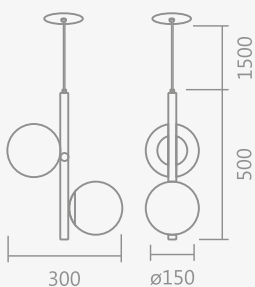

| ID | COR |
|------|----------------|
| 1064 | branco |
| 1065 | cobre polido |
| 1066 | dourado lixado |
| 1067 | dourado onó |
| 1068 | dourado polido |
| 1069 | lixado |
| 1071 | preto |
| 1924 | cobre onó |
| 4938 | cobre lixado |
| 2317 | polido |



800/2 – pendente double

• 2 globos vidro leitoso $\varnothing 120\text{mm}$ – 2 x G9

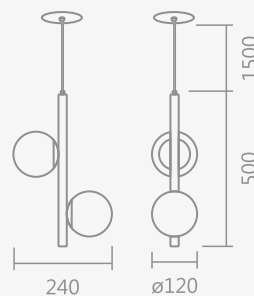

| ID | COR |
|------|----------------|
| 1194 | branco |
| 1195 | cobre lixado |
| 1196 | cobre onó |
| 1197 | cobre polido |
| 1199 | dourado lixado |
| 1200 | dourado onó |
| 1201 | dourado polido |
| 1202 | polido |
| 1203 | preto |
| 3834 | lixado |

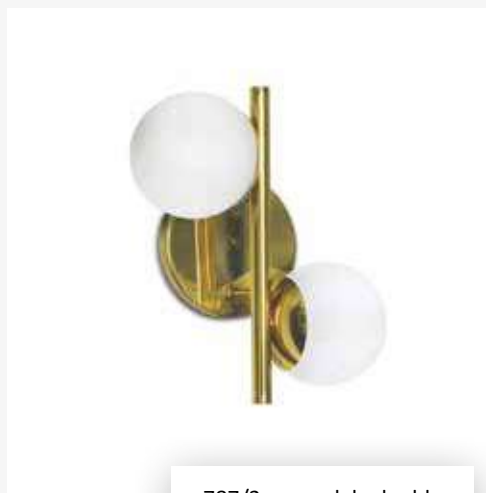

787/2 – arandela double

• 2 globos vidro leitoso ø100mm – 2 x G9

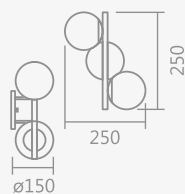

| ID | COR |
|------|----------------|
| 1090 | cobre polido |
| 1091 | cobre lixado |
| 1093 | dourado lixado |
| 1094 | dourado ono |
| 1095 | dourado polido |
| 1096 | preto |
| 2003 | cobre ono |
| 2076 | lixado |
| 2316 | polido |
| 2672 | branco |



linha vega

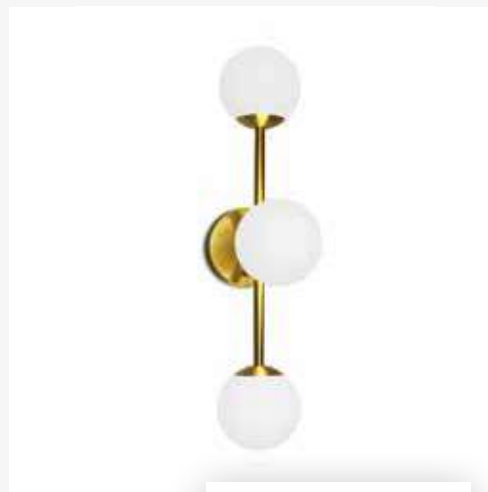

788/3 – arandela vega

• 3 globos vidro leitoso ø100mm – 3 x G9

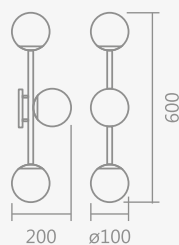

| ID | COR |
|------|----------------|
| 1098 | cobre ono |
| 1099 | cobre polido |
| 1100 | dourado lixado |
| 1101 | dourado ono |
| 1102 | dourado polido |
| 1103 | preto |
| 1936 | branco |
| 2053 | cobre lixado |
| 2072 | lixado |
| 2256 | polido |

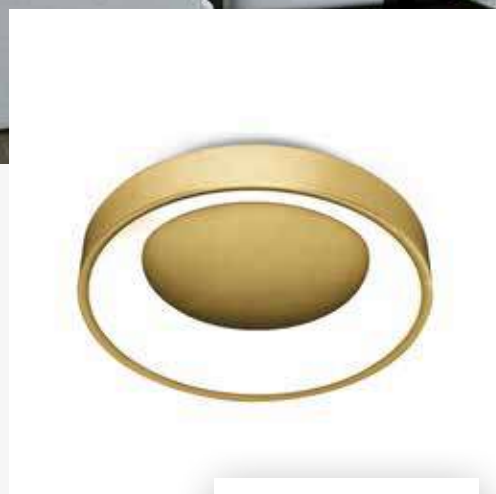

1044 – plafon vale

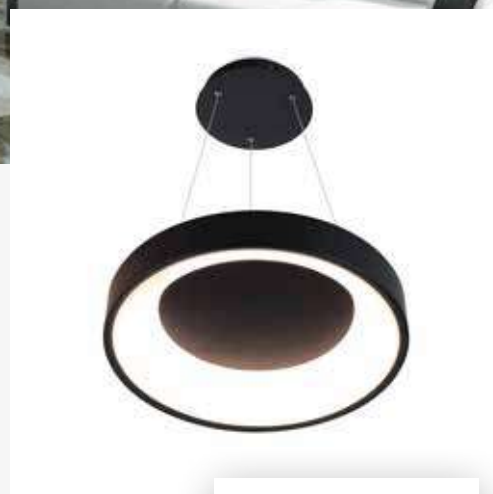

1043 – pendente vale



cód. 1044/35 – ø350mm

- 20 watts – bivolt
- 1500 lumens

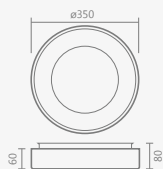

| ID | COR | COR LED |
|------|-------------|---------|
| 4770 | branco | 3000K |
| 4771 | preto | |
| 4772 | dourado ono | |
| 4773 | cobre ono | 4000K |
| 4774 | branco | |
| 4775 | preto | |
| 4776 | dourado ono | |
| 4777 | cobre ono | |

cód. 1043/30 – ø350mm

- 20 watts – bivolt
- 1500 lumens

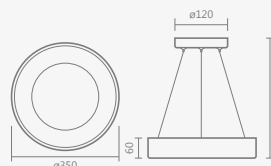

| ID | COR | COR LED |
|------|-------------|---------|
| 4786 | branco | 3000K |
| 4787 | preto | |
| 4788 | dourado ono | |
| 4789 | cobre ono | 4000K |
| 4790 | branco | |
| 4791 | preto | |
| 4792 | dourado ono | |
| 4793 | cobre ono | |

cód. 1044/50 – ø500mm

- 27 watts – bivolt
- 2025 lumens

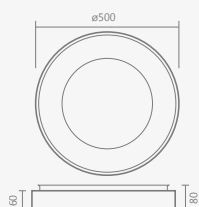

| ID | COR | COR LED |
|------|-------------|---------|
| 4778 | branco | 3000K |
| 4779 | preto | |
| 4780 | dourado ono | |
| 4781 | cobre ono | 4000K |
| 4782 | branco | |
| 4783 | preto | |
| 4784 | dourado ono | |
| 4785 | cobre ono | |

cód. 1043/50 – ø500mm

- 27 watts – bivolt
- 2025 lumens

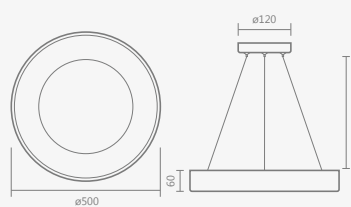

| ID | COR | COR LED |
|------|-------------|---------|
| 4794 | branco | 3000K |
| 4795 | preto | |
| 4796 | dourado ono | |
| 4797 | cobre ono | 4000K |
| 4798 | branco | |
| 4799 | preto | |
| 4800 | dourado ono | |
| 4801 | cobre ono | |

linha delta

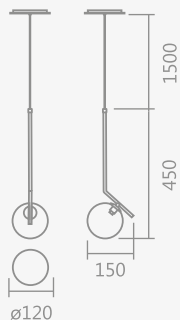

786/1 – pendente delta

• 1 globo vidro \varnothing 120mm – 1 x G9

| ID | COR | GLOBO |
|------|----------------|---------------|
| 2022 | dourado polido | vidro leitoso |
| 2155 | dourado ono | |
| 2158 | preto | |
| 4941 | branco | |
| 4942 | polido | |
| 4944 | cobre polido | vidro duo |
| 2159 | cobre ono | |
| 1077 | cobre polido | |
| 1081 | dourado ono | |
| 1082 | dourado polido | |
| 1086 | preto | vidro ambar |
| 1888 | cobre ono | |
| 2328 | dourado ono | |
| 4945 | branco | |
| 4339 | polido | |
| 1073 | branco | vidro ambar |
| 1075 | cobre ono | |
| 1076 | cobre polido | |
| 1080 | dourado ono | |
| 1085 | preto | |
| 4946 | polido | vidro ambar |
| 1089 | dourado polido | |

linha cali



795/1 – pendente cali

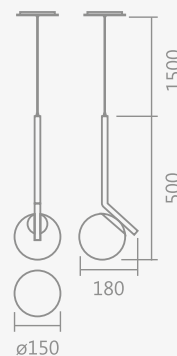

• 1 globo vidro leitoso \varnothing 150mm – 1 x E27

| ID | COR |
|------|-------------|
| 1162 | branco |
| 1163 | cobre ono |
| 1166 | dourado ono |
| 1170 | preto |

linha vigo

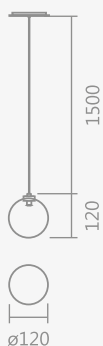

799/1 – pendente vigo

• 1 globo vidro \varnothing 120mm – 1 x G9

| ID | COR | GLOBO |
|------|----------------|-------------|
| 1185 | cobre polido | vidro duo |
| 1187 | dourado lixado | |
| 1189 | dourado ono | |
| 1191 | dourado polido | |
| 1193 | branco | |
| 2233 | cobre ono | vidro ambar |
| 2343 | lixado | |
| 2639 | preto | |
| 4738 | polido | |
| 1184 | cobre polido | |
| 1186 | dourado lixado | vidro ambar |
| 1188 | dourado ono | |
| 1190 | dourado polido | |
| 1192 | preto | |
| 4340 | cobre ono | |
| 4850 | cobre lixado | vidro ambar |
| 4954 | branco | |
| 4887 | lixado | |

linha glass



70



782 – pendente glass

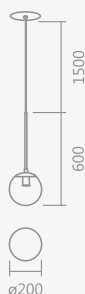

globo: ø200mm

cód. 782/20

- 1 globo vidro ambar ø200mm – 1 x E27

| ID | COR |
|------|----------------|
| 1055 | cobre polido |
| 1056 | dourado polido |
| 1057 | lixado |
| 1058 | preto |
| 1925 | cobre ono |
| 1948 | dourado ono |
| 2188 | rose |
| 3073 | polido |

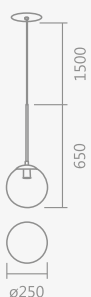

globo: ø250mm

cód. 782/25

- 1 globo vidro ambar ø250mm – 1 x E27

| ID | COR |
|------|----------------|
| 1059 | dourado lixado |
| 1060 | cobre polido |
| 1061 | dourado polido |
| 1062 | preto |
| 1969 | cobre ono |
| 2196 | dourado ono |
| 2321 | rose |
| 2807 | cobre lixado |

linha delta



790/1 – arandela delta



- 1 globo vidro ø120mm – 1 x G9

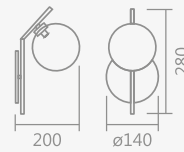

| ID | COR | GLOBO |
|------|----------------|---------------|
| 1115 | branco | vidro ambar |
| 1116 | cobre onô | |
| 1118 | cobre polido | |
| 1122 | dourado onô | |
| 1124 | dourado polido | vidro duo |
| 1127 | preto | |
| 1117 | cobre onô | |
| 1119 | cobre polido | |
| 1123 | dourado onô | vidro leitoso |
| 4955 | dourado polido | |
| 2120 | branco | |
| 2121 | preto | |
| 1120 | cobre polido | vidro leitoso |
| 1128 | preto | |
| 2301 | polido | |
| 4956 | branco | |
| 2496 | cobre onô | vidro leitoso |
| 2621 | dourado onô | |



linha uno



791/1 – arandela uno



- 1 globo vidro leitoso ø150mm – 1 x E27

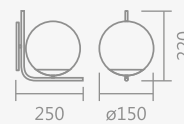

| ID | COR |
|------|----------------|
| 1130 | branco |
| 1131 | cobre lixado |
| 1132 | cobre onô |
| 1133 | cobre polido |
| 1134 | dourado lixado |
| 1135 | dourado onô |
| 1136 | polido |
| 1137 | preto |
| 1138 | dourado polido |
| 3878 | lixado |



linha pêndulo



72

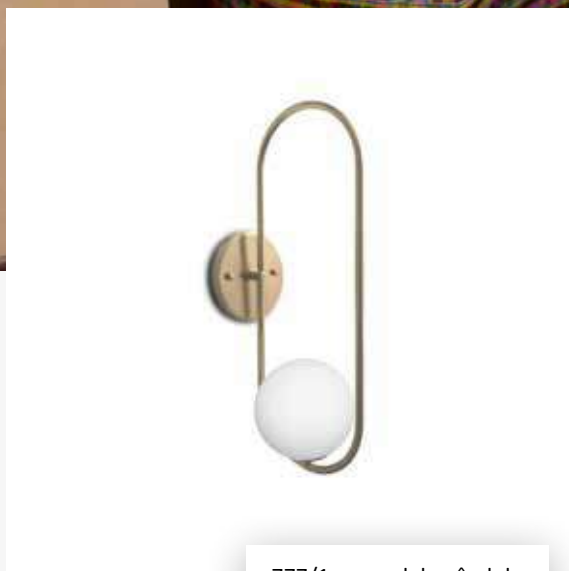

777/1 – arandela pêndulo



778/1 – pendente pêndulo

• 1 globo vidro leitoso \varnothing 120mm – 1 x G9

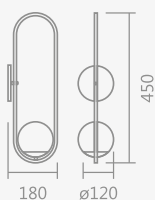

| ID | COR |
|------|----------------|
| 997 | branco |
| 999 | cobre onô |
| 1000 | cobre polido |
| 1001 | dourado onô |
| 1002 | dourado polido |
| 1003 | polido |
| 1004 | preto |

• 1 globo vidro leitoso \varnothing 120mm – 1 x G9

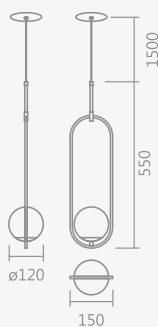

| ID | COR |
|------|----------------|
| 1007 | branco |
| 1010 | cobre onô |
| 1011 | cobre polido |
| 1014 | dourado onô |
| 1015 | dourado polido |
| 1018 | preto |
| 1019 | rose |
| 1020 | polido |

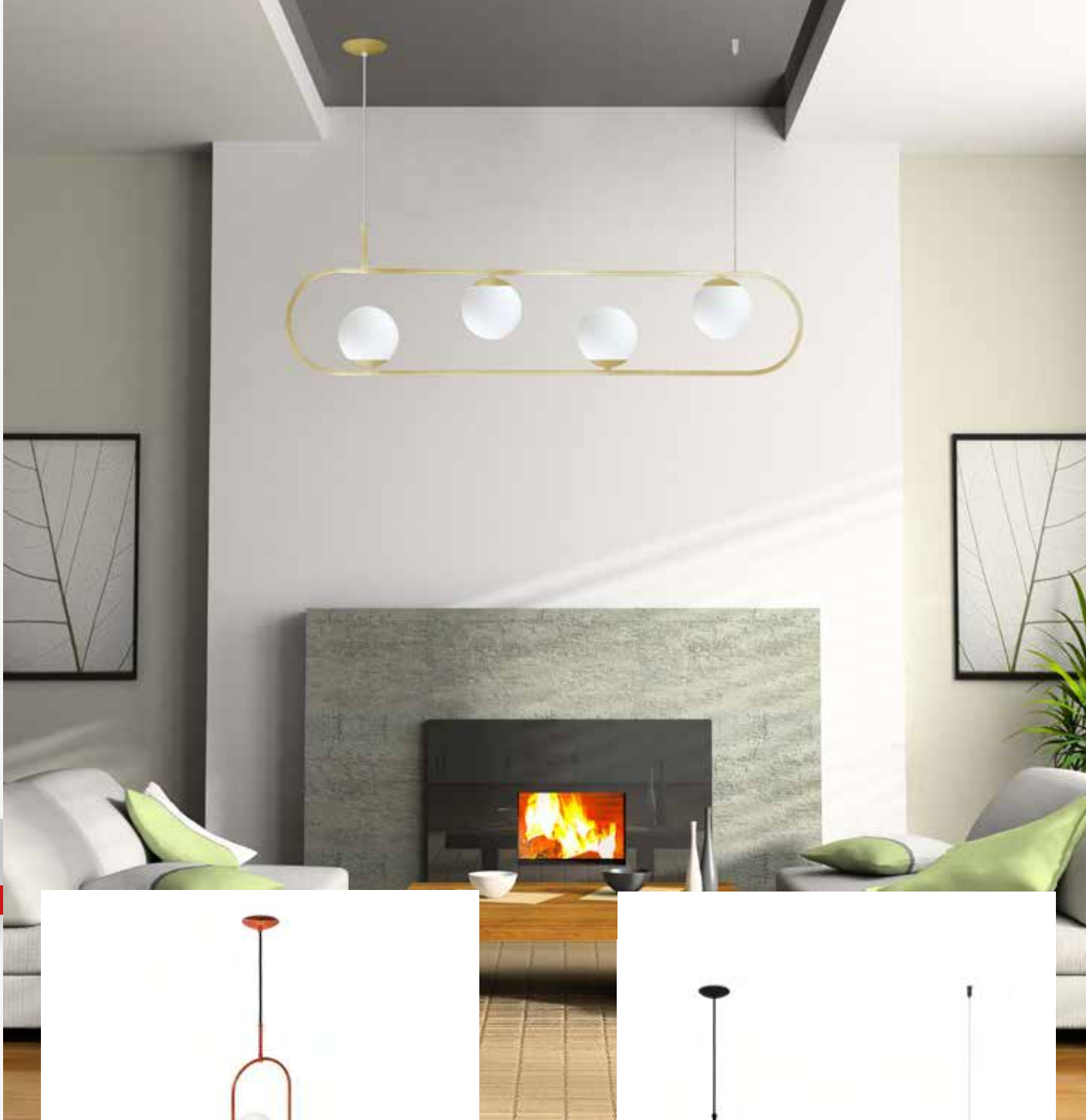

778/2 – pendente pêndulo

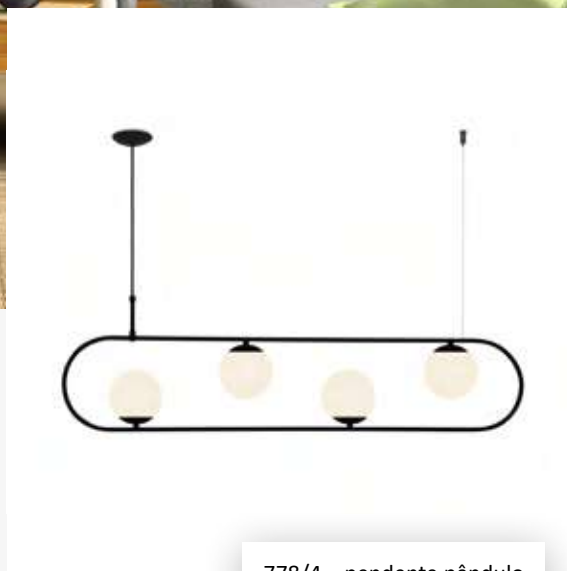

778/4 – pendente pêndulo

• 4 globos vidro leitoso $\varnothing 120\text{mm}$ – 4 x G9

• 2 globos vidro leitoso $\varnothing 120\text{mm}$ – 2 x G9

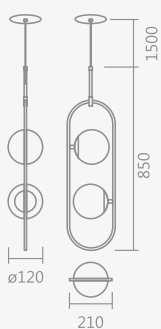

| ID | COR |
|------|----------------|
| 1022 | dourado polido |
| 1024 | cobre polido |
| 1025 | dourado ono |
| 1026 | polido |
| 1027 | preto |
| 2096 | cobre ono |
| 4854 | branco |

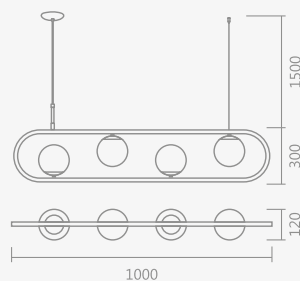

| ID | COR |
|------|----------------|
| 1028 | branco |
| 1029 | cobre ono |
| 1031 | dourado ono |
| 1033 | preto |
| 2068 | polido |
| 1032 | dourado polido |
| 1030 | cobre polido |

linha gota



74



779/1 – pendente gota



820/1 – arandela gota

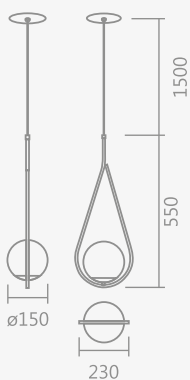

• 1 globo vidro leitoso \varnothing 150mm – 1 x E27

| ID | COR |
|------|----------------|
| 1041 | cobre ono |
| 1044 | dourado ono |
| 1045 | dourado polido |
| 1048 | polido |
| 1049 | preto |
| 1037 | branco |
| 1035 | cobre polido |
| 1050 | rose |

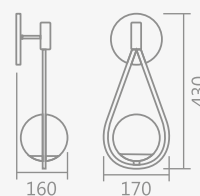

• 1 globo vidro leitoso \varnothing 120mm – 1 x G9

| ID | COR |
|------|----------------|
| 1398 | branco |
| 1399 | cobre ono |
| 1400 | cobre polido |
| 1401 | dourado ono |
| 1402 | dourado polido |
| 1404 | polido |
| 1406 | preto |
| 1407 | rose |

linha tromp



815/1 – arandela tromp

- 1 globo vidro leitoso \varnothing 150mm – 1 x E27

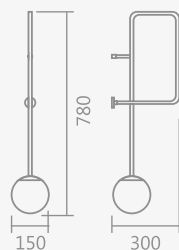

| ID | COR |
|------|----------------|
| 1368 | cobre polido |
| 1370 | dourado ono |
| 1371 | dourado polido |
| 1372 | preto |
| 2170 | polido |



75

linha torch



817/1 – arandela torch

cúpula não
acompanha o
produto.

- 1 soquete E27

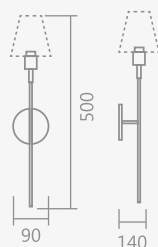

| ID | COR |
|------|----------------------|
| 1388 | preto |
| 1390 | preto/dourado lixado |
| 1391 | preto/dourado ono |
| 1945 | preto/dourado polido |
| 1951 | branco |
| 2130 | dourado lixado |
| 2574 | preto/cobre polido |
| 2616 | polido |
| 2995 | preto/cobre lixado |

linha shell



803/1 – arandela shell

• 1 soquete G9

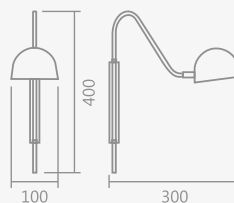

| ID | COR |
|------|-----------------------|
| 1225 | branco |
| 1226 | cobre ono |
| 1227 | cobre polido |
| 1229 | dourado ono |
| 1230 | dourado polido |
| 1231 | preto |
| 1232 | preto/cobre polido |
| 1233 | preto/dourado ono |
| 1909 | preto/cobre ono |
| 2040 | preto/dourado lixado |
| 2165 | preto/dourado |
| 2186 | branco/dourado lixado |
| 2627 | polido |
| 4895 | branco/dourado ono |



76

linha dome



835/1 – arandela dome

• 1 soquete G9

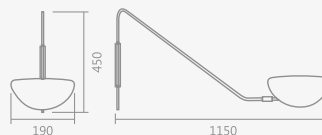

| ID | COR |
|------|-----------------------|
| 1495 | preto/dourado lixado |
| 1496 | branco |
| 1498 | branco/dourado lixado |
| 1499 | branco/dourado ono |
| 1500 | cobre ono |
| 1501 | dourado polido |
| 1502 | preto |
| 1503 | preto/dourado ono |
| 1504 | preto/dourado polido |
| 2063 | polido |
| 2064 | dourado lixado |
| 2091 | branco/cobre ono |
| 2109 | preto/cobre lixado |
| 2174 | cobre lixado |
| 2234 | branco/dourado polido |
| 2254 | preto/cobre ono |
| 2454 | preto/cobre polido |
| 3060 | preto/branco |
| 3203 | dourado ono |
| 4520 | cobre polido |

linha haste



793/1 – arandela haste

- 1 soquete E27

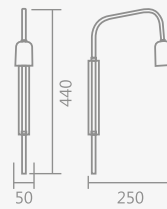

| ID | COR |
|------|----------------|
| 1150 | branco |
| 1151 | cobre ono |
| 1152 | cobre polido |
| 1153 | dourado lixado |
| 1154 | dourado ono |
| 1155 | dourado polido |
| 1156 | preto |
| 1157 | rose |



77

linha búzios



794/1 – Arandela Búzios

- 1 globo vidro leitoso \varnothing 120mm – 1 x G9

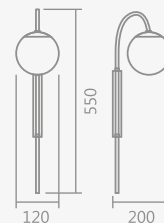

| ID | COR |
|------|----------------|
| 1158 | cobre ono |
| 1159 | dourado ono |
| 1160 | dourado polido |
| 1903 | preto |
| 2115 | dourado lixado |
| 2150 | branco fosco |
| 3270 | cobre lixado |
| 4320 | polido |
| 4383 | cobre polido |

linha maze



825/30 – plafon maze

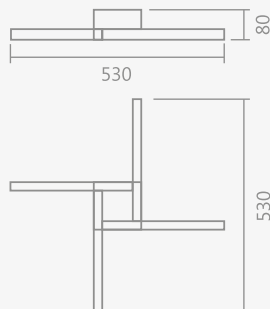

- 22 watts – bivolt
- 1650 lumens

| ID | COR | COR LED |
|------|-------------|---------|
| 1447 | branco | 3000K |
| 1449 | preto | |
| 1892 | dourado ono | 4000K |
| 1450 | branco | |
| 4967 | dourado ono | |
| 1451 | preto | |



linha kit



812/60 – plafon kit



812/120 – plafon kit



- 18 watts – bivolt
- 1350 lumens

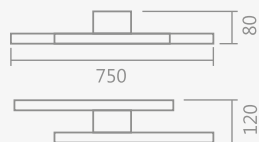

| ID | COR | COR LED |
|------|-------------|---------|
| 1349 | branco | 3000K |
| 1350 | dourado ono | |
| 1351 | preto | |
| 4324 | cobre ono | 4000K |
| 1901 | branco | |
| 2207 | preto | |
| 4968 | dourado ono | |
| 4969 | cobre ono | |

- 38 watts – bivolt
- 2850 lumens

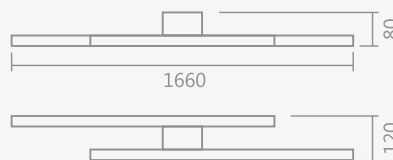

| ID | COR | COR LED |
|------|-------------|---------|
| 1348 | preto | 3000K |
| 1875 | dourado ono | |
| 1893 | cobre ono | |
| 2041 | branco | 4000K |
| 1900 | preto | |
| 4970 | dourado ono | |
| 4971 | cobre ono | |
| 2111 | branco | |

linha event



80



829/3 – pendente event

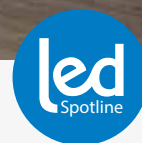
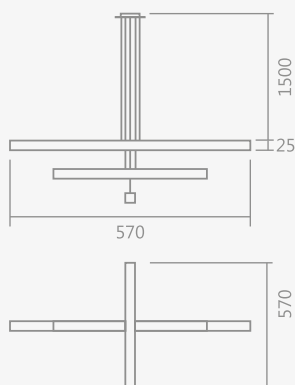

- 30 watts – bivolt
- 2250 lumens

| ID | COR | COR LED |
|------|-------------|---------|
| 1462 | preto | 3000K |
| 3068 | branco | |
| 3253 | dourado ono | |
| 2208 | preto | 4000K |
| 4972 | dourado ono | |
| 3011 | branco | |

linha only



81

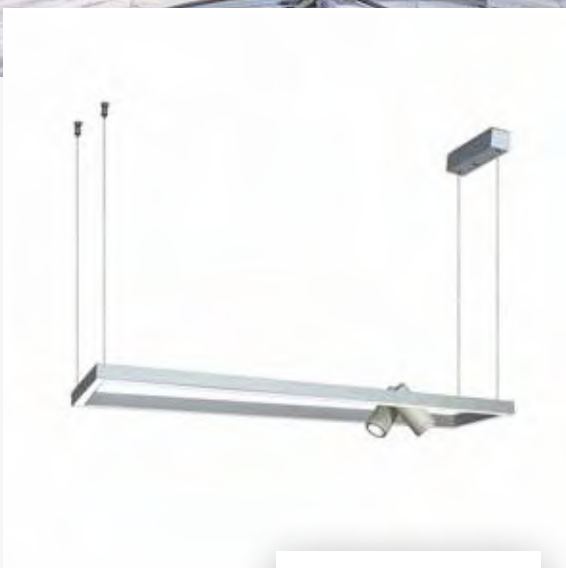

830/1 – pendente only

- 34 watts – bivolt
- 2550 lumens
- 2 spots MR11 – 2 x GU10

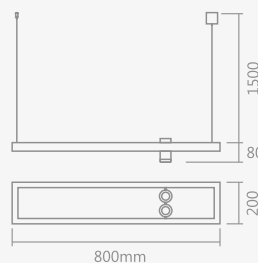

| ID | COR | COR LED |
|------|-----------------------|---------|
| 1463 | branco | 3000K |
| 1465 | preto | |
| 1466 | preto/cobre lixado | |
| 1467 | preto/cobre polido | |
| 1468 | preto/dourado polido | |
| 1861 | preto/dourado ono | |
| 2124 | dourado ono | 4000K |
| 2164 | preto/dourado lixado | |
| 4867 | branco/dourado lixado | |
| 2125 | dourado ono | |
| 2140 | preto/dourado lixado | |
| 2203 | branco | |
| 2204 | cobre ono | |
| 3136 | preto | |
| 4973 | preto/cobre lixado | 4000K |
| 4974 | preto/cobre polido | |
| 4975 | preto/dourado polido | |
| 4976 | preto/dourado ono | |

linha aria

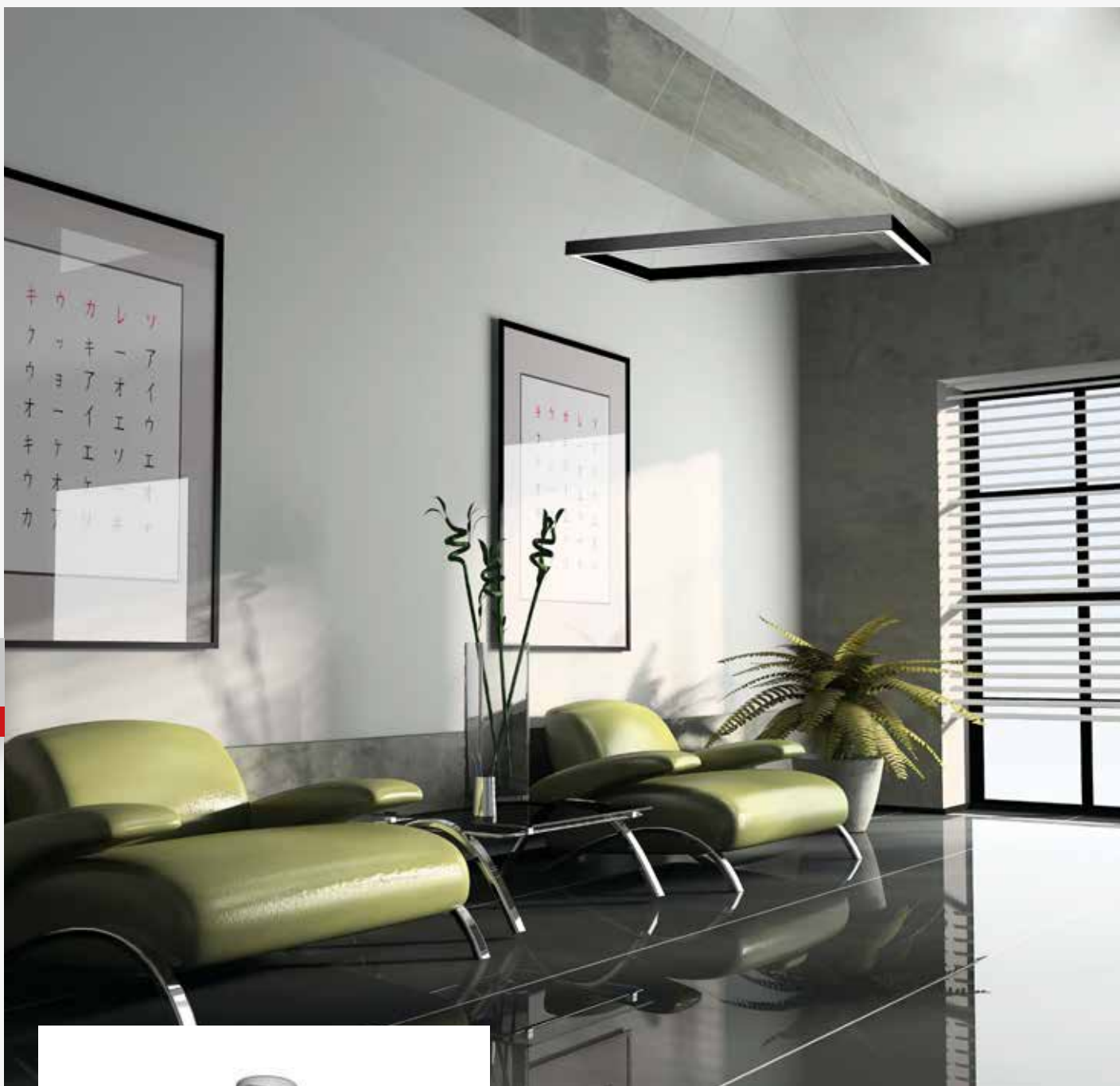

826/1 – pendente aria

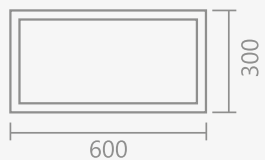
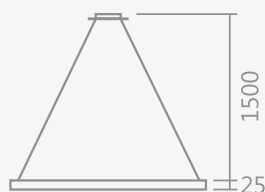

- 30 watts – bivolt – bivolt
- 2250 lumens

| ID | COR | COR LED |
|------|-------------|---------|
| 1452 | branco | 3000K |
| 1453 | preto | |
| 4328 | dourado ono | |
| 2097 | branco | 4000K |
| 2503 | preto | |
| 2595 | dourado ono | |





828/1 – pendente aria



828/2 – pendente aria

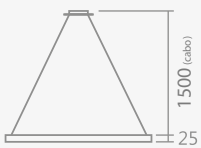

- 34 watts – bivolt
- 2550 lumens

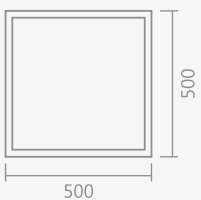

| ID | COR | COR LED |
|------|-------------|---------|
| 2168 | preto | 3000K |
| 2778 | branco | |
| 4721 | dourado ono | |
| 1458 | preto | 4000K |
| 2059 | dourado ono | |
| 2093 | branco | |

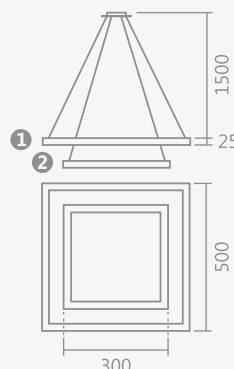

- 60 watts – bivolt
- 4500 lumens

| ID | COR | COR LED |
|------|-------------|---------|
| 2253 | preto | 3000K |
| 3178 | branco | |
| 3893 | dourado ono | |
| 4686 | cobre ono | 4000K |
| 1459 | branco | |
| 1460 | cobre ono | |
| 1461 | dourado ono | |
| 1913 | preto | |

linha office



84



- 18 watts – bivolt
- 1350 lumens

- opção dos anéis:
alumínio (DL ou CO/L) ou madeira



811/120 – pendente office

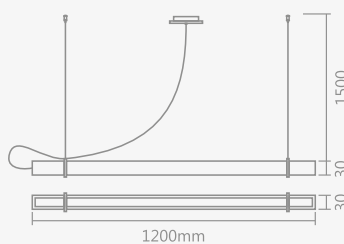

| ID | COR | COR LED |
|------|-----------------------|---------|
| 1340 | branco | 3000K |
| 1344 | preto | |
| 1937 | branco/anel madeira | |
| 2025 | preto/dourado lixado | |
| 2138 | preto/anel madeira | |
| 2264 | branco/cobre lixado | |
| 2265 | preto/cobre lixado | 4000K |
| 2494 | branco/dourado lixado | |
| 1341 | branco | |
| 1342 | branco/cobre lixado | |
| 1343 | branco/dourado lixado | |
| 1345 | preto | |
| 1346 | preto/cobre lixado | |
| 1347 | preto/dourado lixado | |
| 1870 | preto/anel madeira | 4000K |
| 2184 | branco/anel madeira | |
| 4400 | branco/dourado ono | |

linha road



814/120 – pendente road

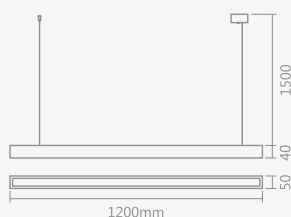

- 38 watts – bivolt
- 2850 lumens

| ID | COR | COR LED |
|------|--------|---------|
| 1364 | preto | 3000K |
| 2019 | branco | |
| 1361 | branco | 4000K |
| 1365 | preto | |

linha hall



85



810/60 – pendente hall

- 18 watts – bivolt
- 1350 lumens

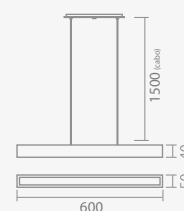

| ID | COR | COR LED |
|------|-------------|---------|
| 1335 | branco | 3000K |
| 1338 | preto | |
| 5045 | dourado ono | 4000K |
| 5046 | cobre ono | |
| 1339 | preto | 4000K |
| 1336 | branco | |
| 5047 | cobre ono | |
| 5048 | dourado ono | |



810/120 – pendente hall

- 38 watts – bivolt
- 2850 lumens

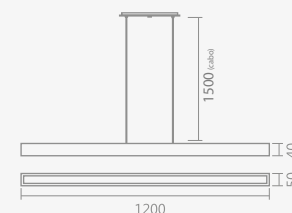

| ID | COR | COR LED |
|------|-------------|---------|
| 1332 | branco | 3000K |
| 1333 | preto | |
| 1848 | dourado ono | 4000K |
| 4879 | cobre ono | |
| 2584 | branco | 4000K |
| 1334 | preto | |
| 4327 | dourado ono | |
| 4978 | cobre ono | |

linha vanity

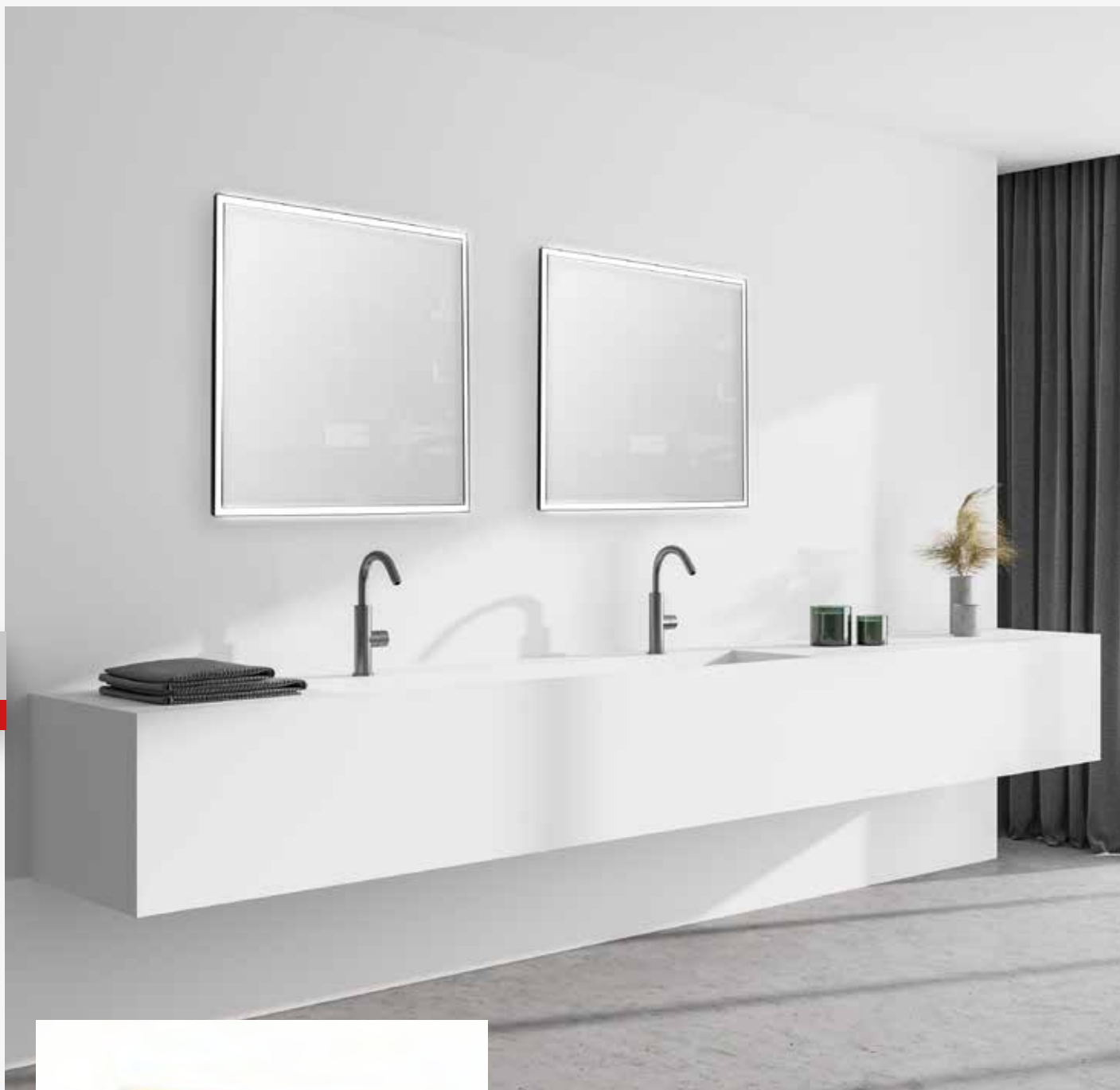

86

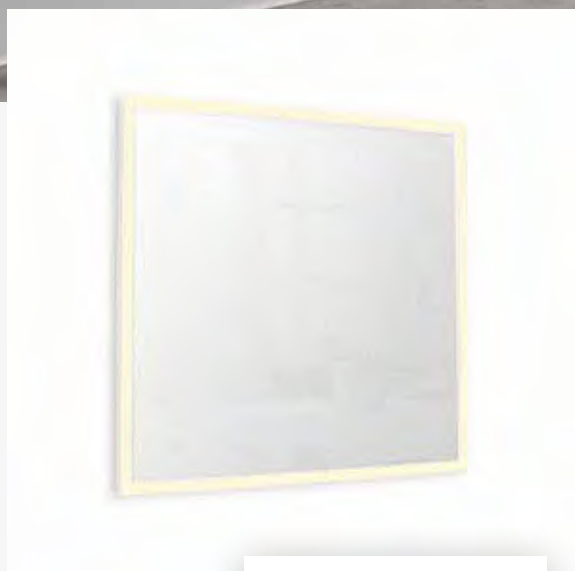

831/60 – espelho vanity



- 40 watts – bivolt
- 3000 lumens

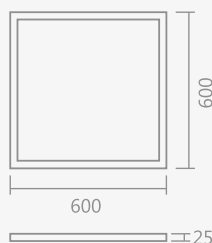

| ID | COR | COR LED |
|------|-------------|---------|
| 1473 | branco | 3000K |
| 1474 | preto | |
| 2218 | dourado ono | 4000K |
| 1993 | branco | |
| 3779 | preto | |
| 4897 | dourado ono | |

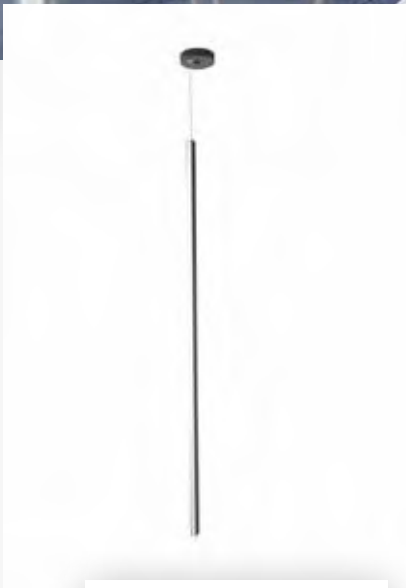

858/120 – pendente style



865/1 – luminária de mesa style



844/1 – coluna style

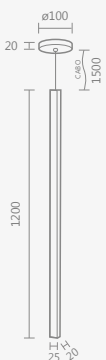

- 22 watts – bivolt
- 1650 lumens

| ID | COR | COR LED |
|------|--------|---------|
| 2906 | preto | 3000K |
| 2907 | branco | |
| 2951 | preto | 4000K |
| 2952 | branco | |

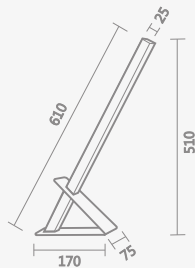

- 8 watts – bivolt
- 600 lumens

| ID | COR | COR LED |
|------|--------|---------|
| 2900 | preto | 3000K |
| 2902 | branco | |
| 2944 | preto | 4000K |
| 2945 | branco | |

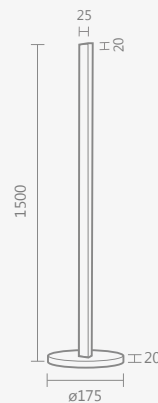

- 22 watts – bivolt
- 1650 lumens

| ID | COR | COR LED |
|------|-------------|---------|
| 2533 | branco | 3000K |
| 2532 | preto | |
| 4823 | dourado ono | 4000K |
| 2933 | branco | |
| 2932 | preto | |
| 4983 | dourado ono | |

linha style



88

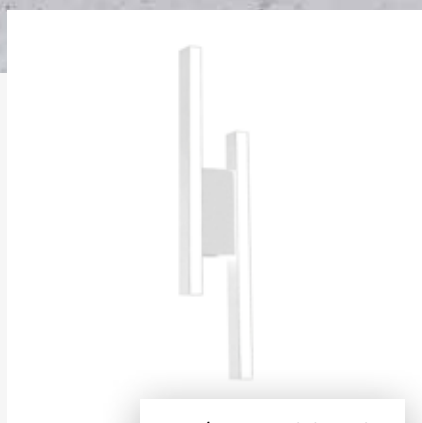

822/2 – arandela style



822/30 – arandela style

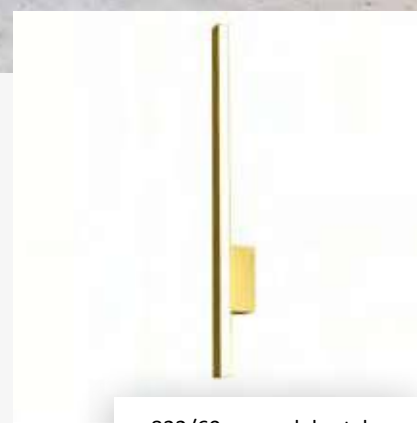

822/60 – arandela style



- 9,5 watts – bivolt
- 712,5 lumens
- iluminação direta

| ID | COR | COR LED |
|------|-------------|---------|
| 1417 | branco | 3000K |
| 1419 | preto | |
| 1868 | cobre ono | |
| 2775 | dourado ono | 4000K |
| 1949 | dourado ono | |
| 2213 | preto | |
| 4979 | cobre ono | |
| 2632 | branco | |



- 5 watts – bivolt
- 375 lumens
- iluminação direta

| ID | COR | COR LED |
|------|-------------|---------|
| 3156 | branco | 3000K |
| 1421 | preto | |
| 2198 | cobre ono | |
| 4982 | dourado ono | 4000K |
| 2210 | branco | |
| 4980 | preto | |
| 4981 | cobre ono | |
| 2490 | dourado ono | |

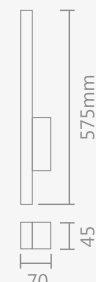

- 8,5 watts – bivolt
- 637,5 lumens
- iluminação direta

| ID | COR | COR LED |
|------|-------------|---------|
| 1422 | branco | 3000K |
| 1425 | preto | |
| 2319 | cobre ono | |
| 1908 | dourado ono | 4000K |
| 1423 | branco | |
| 4521 | preto | |
| 5058 | cobre ono | |
| 1424 | dourado ono | |



823/30 – arandela style



823/60 – arandela style



- 5 watts – bivolt
- 375 lumens
- iluminação indireta



| ID | COR | COR LED |
|------|-------------|---------|
| 1426 | branco | 3000K |
| 1428 | preto | |
| 1989 | dourado ono | 4000K |
| 2211 | branco | |
| 5039 | preto | |
| 5040 | dourado ono | |

- 8,5 watts – bivolt
- 637,5 lumens
- iluminação indireta



| ID | COR | COR LED |
|------|-------------|---------|
| 1429 | cobre ono | 3000K |
| 1430 | dourado ono | |
| 1431 | preto | |
| 1847 | branco | 4000K |
| 1432 | preto | |
| 4984 | cobre ono | |
| 2062 | branco | |
| 3229 | dourado ono | |

linha verssat



499/1 – pendente verssat



634/1 – pendente verssat



• 1 soquete G9

| ID | COR |
|------|----------------|
| 299 | branco |
| 300 | cobre polido |
| 301 | dourado polido |
| 302 | polido |
| 304 | preto |
| 305 | cobre lixado |
| 306 | dourado lixado |
| 1942 | dourado ono |

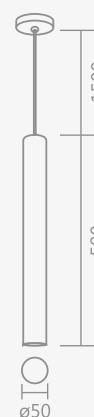

• 1 soquete GU10/MR16

| ID | COR |
|------|----------------|
| 342 | branco |
| 344 | cobre polido |
| 346 | dourado polido |
| 4985 | polido |
| 3485 | preto |
| 343 | cobre lixado |
| 345 | dourado lixado |
| 2050 | dourado ono |



linha long



743/6 – pendente long

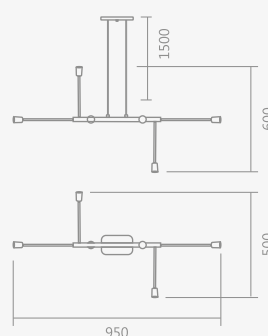

• 6 soquetes E27

| ID | COR |
|------|----------------|
| 928 | cobre polido |
| 930 | branco |
| 932 | cobre lixado |
| 933 | dourado lixado |
| 934 | dourado ono |
| 935 | dourado polido |
| 936 | polido |
| 937 | preto |
| 1887 | cobre ono |

linha century

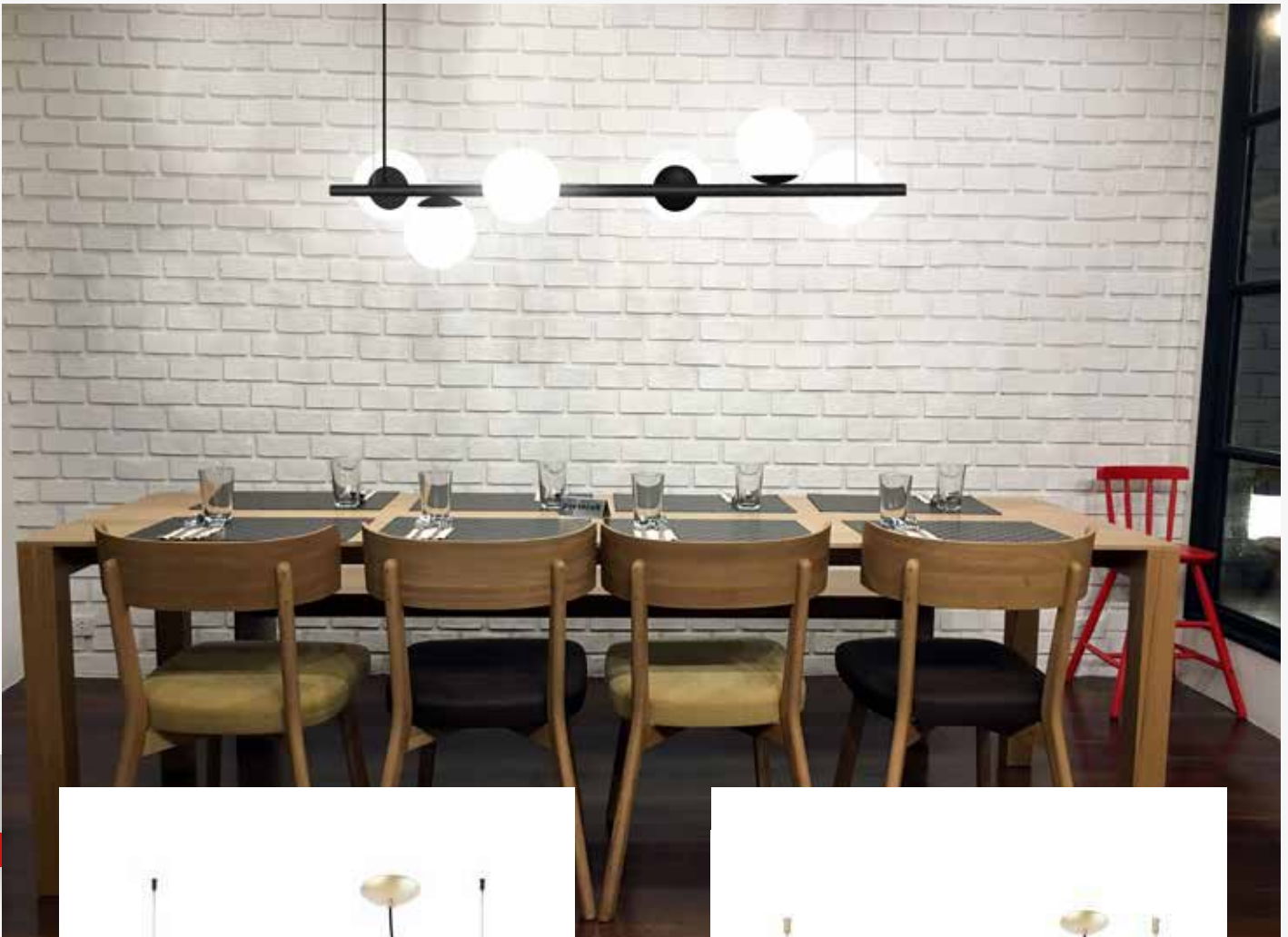

91



733/3 – pendente century

• 3 globos vidro leitoso \varnothing 150mm – 3 x E27



733/6 – pendente century

• 6 globos vidro leitoso \varnothing 150mm – 6 x E27

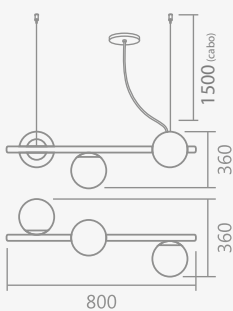

| ID | COR |
|------|----------------|
| 849 | branco |
| 851 | cobre ono |
| 852 | cobre polido |
| 854 | dourado lixado |
| 855 | dourado ono |
| 856 | dourado polido |
| 858 | preto |
| 859 | polido |
| 2353 | lixado |
| 2998 | cobre lixado |

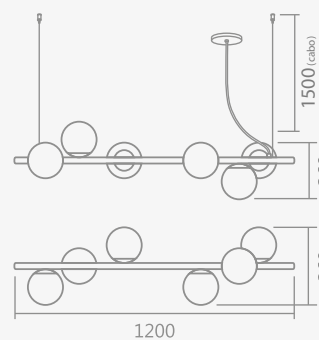

| ID | COR |
|-----|----------------|
| 860 | branco |
| 861 | cobre lixado |
| 862 | cobre ono |
| 863 | cobre polido |
| 865 | dourado lixado |
| 866 | dourado ono |
| 867 | dourado polido |
| 868 | lixado |
| 870 | polido |
| 871 | preto |

linha angulus



744/4 – pendente angulus

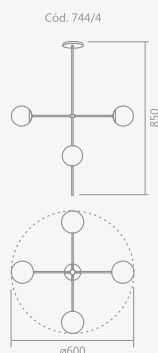

- 4 globos vidro leitoso \varnothing 120mm – 4 x G9

| ID | COR |
|------|----------------|
| 939 | branco |
| 941 | cobre lixado |
| 942 | cobre onô |
| 943 | cobre polido |
| 945 | dourado onô |
| 946 | dourado polido |
| 947 | preto |
| 2236 | dourado lixado |
| 3186 | polido |



92

linha rob



742/6 – pendente rob

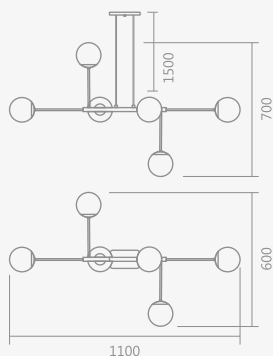

- 6 globos vidro leitoso \varnothing 120mm – 6 x G9

| ID | COR |
|------|----------------|
| 919 | branco |
| 920 | cobre lixado |
| 921 | cobre onô |
| 922 | cobre polido |
| 923 | dourado onô |
| 924 | dourado polido |
| 925 | polido |
| 926 | preto |
| 2966 | dourado lixado |

linha soft



761/1 – arandela soft

- 1 globo vidro leitoso \varnothing 150mm – 1 x E27

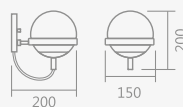

| ID | COR |
|------|----------------|
| 974 | branco |
| 975 | cobre polido |
| 977 | dourado ono |
| 978 | dourado polido |
| 980 | polido |
| 982 | preto |
| 2088 | cobre ono |



93

linha argo



732/1 – pendente argo

- 1 globo vidro leitoso \varnothing 150mm – 1 x E27

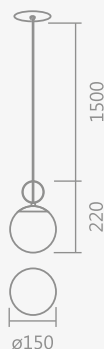

| ID | COR |
|-----|----------------|
| 837 | dourado lixado |
| 838 | branco |
| 840 | cobre ono |
| 841 | cobre polido |
| 843 | dourado ono |
| 844 | dourado polido |
| 846 | polido |
| 847 | preto |

linha bronx

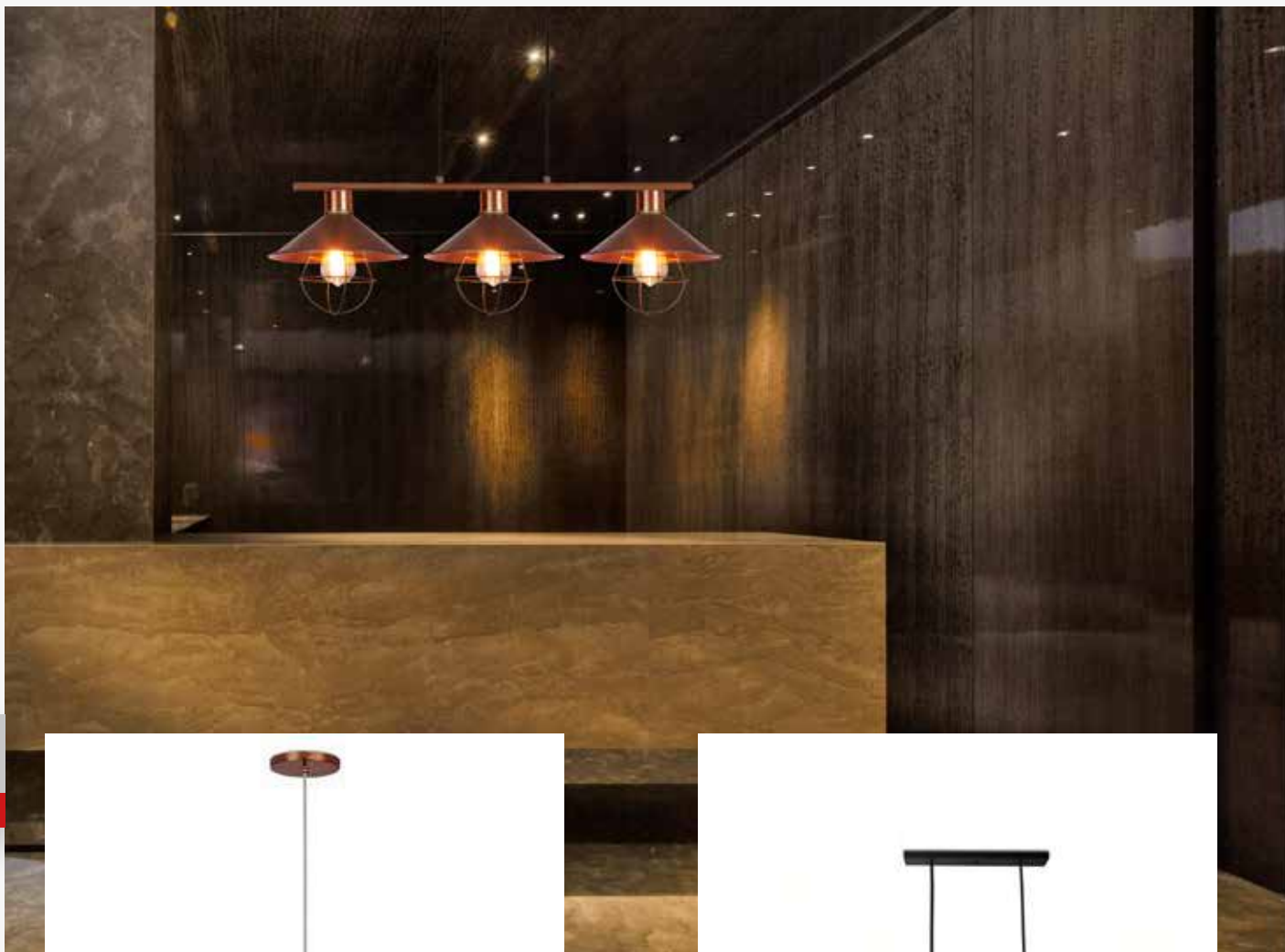

94



636/1 – pendente bronx



636/3 – pendente bronx



• 1 soquete E27

| ID | COR |
|------|--------------------|
| 349 | cobre polido |
| 350 | preto |
| 351 | preto/cobre polido |
| 2261 | dourado ono |
| 3614 | preto/cobre ono |

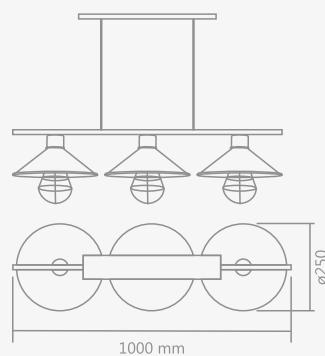

• 3 soquetes E27

| ID | COR |
|------|----------------------|
| 352 | café/cobre polido |
| 353 | cobre polido |
| 355 | preto/cobre polido |
| 1871 | dourado ono |
| 2666 | preto/dourado polido |
| 2836 | preto |

linha queens

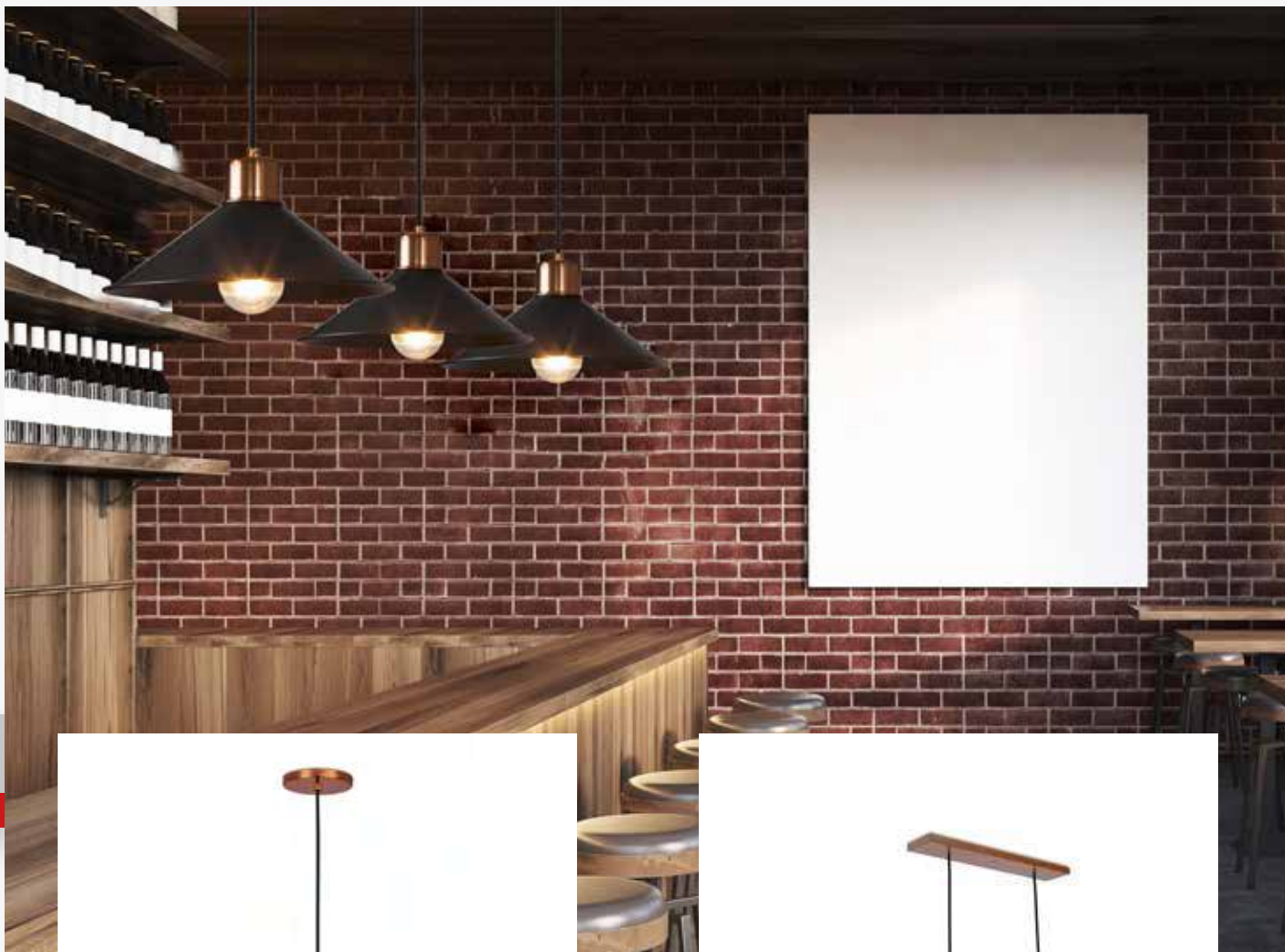

95

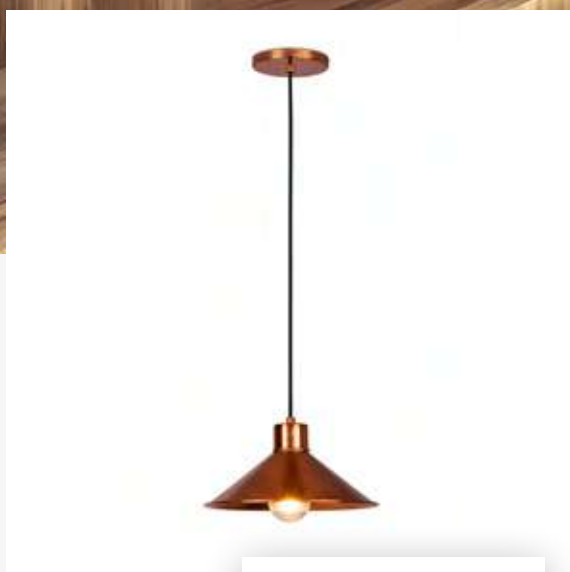

633/1 – pendente queens

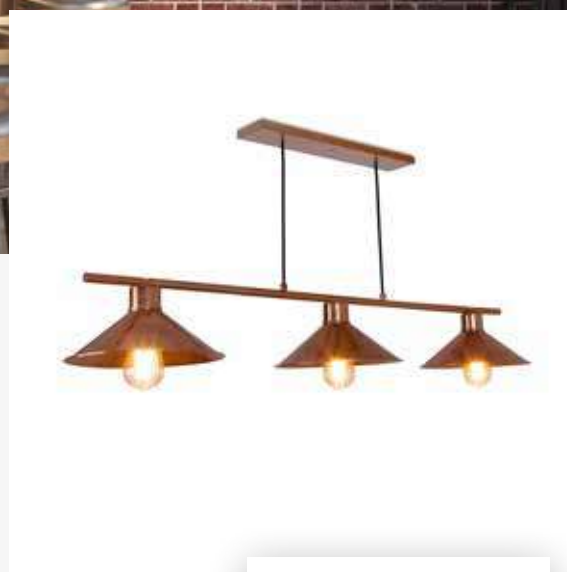

633/3 – pendente queens

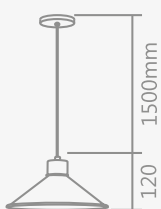

• 1 soquete E27

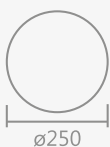

| ID | COR |
|------|----------------------|
| 330 | cobre polido |
| 2723 | preto |
| 331 | preto/cobre polido |
| 332 | preto/dourado polido |
| 2725 | dourado polido |
| 2082 | preto/dourado ono |
| 2238 | cobre ono |

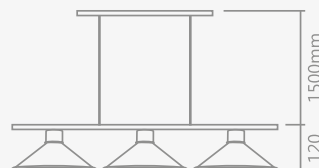

• 3 soquetes E27

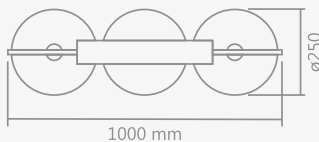

| ID | COR |
|------|----------------------|
| 338 | cobre polido |
| 339 | preto |
| 340 | preto/cobre polido |
| 2255 | preto/dourado polido |
| 2724 | dourado polido |
| 4676 | preto/dourado ono |
| 4880 | preto/cobre ono |

linha martin



723/8 – pendente martin



723/12 – pendente martin

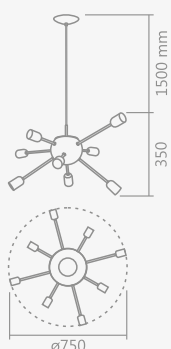

• 8 soquetes E27

| ID | COR |
|------|----------------------|
| 808 | branco/cobre polido |
| 810 | cobre onô |
| 811 | cobre polido |
| 812 | dourado onô |
| 813 | dourado polido |
| 815 | preto |
| 816 | preto/cobre onô |
| 817 | preto/cobre polido |
| 2481 | preto/dourado onô |
| 809 | branco/dourado onô |
| 4988 | preto/dourado polido |

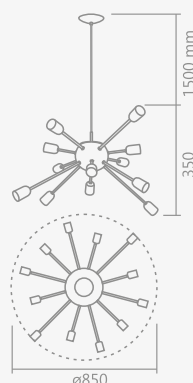

• 12 soquetes E27

| ID | COR |
|------|----------------------|
| 796 | branco/cobre polido |
| 797 | cobre onô |
| 798 | cobre polido |
| 799 | dourado onô |
| 800 | dourado polido |
| 802 | preto |
| 804 | preto/cobre onô |
| 805 | preto/cobre polido |
| 2482 | preto/dourado onô |
| 2563 | branco/dourado onô |
| 3723 | preto/dourado polido |



linha square



646/1 – coluna square



- soquete: 1 x E27

| ID | COR |
|------|-----------------------|
| 398 | branco |
| 401 | cobre polido/branco |
| 406 | preto |
| 409 | dourado polido/branco |
| 2014 | preto/branco |
| 2079 | cobre ono |
| 2367 | dourado ono |
| 2626 | preto/dourado ono |



97

linha prime



415/1 – pendente prime

Cód. 415/1



- 1 soquete E27

| ID | COR |
|------|----------------------|
| 166 | branco |
| 167 | branco/cobre polido |
| 169 | cobre polido |
| 170 | dourado polido |
| 172 | preto |
| 173 | preto/cobre ono |
| 174 | preto/cobre polido |
| 2519 | preto/dourado polido |

linha new smart



735 – plafon new smart



736 – pendente new smart

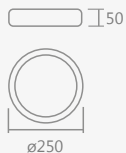

cód. 735/25
• 18 watts – bivolt
• 1350 lumens

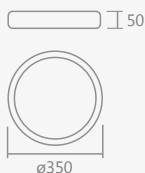

cód. 735/35
• 36 watts – bivolt
• 2700 lumens

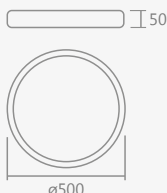

cód. 735/50
• 50 watts – bivolt
• 3750 lumens

PLAFONS

| ID | COR | LED | ID | COR | LED | ID | COR | LED |
|------|----------------|-------|------|----------------|-------|------|----------------|-------|
| 873 | branco | 3000K | 882 | branco | 3000K | 894 | branco | 3000K |
| 877 | dourado polido | | 884 | cobre polido | | 899 | dourado polido | |
| 879 | preto | | 889 | dourado polido | | 901 | preto | |
| 2376 | cobre polido | 6000K | 891 | preto | 6000K | 4992 | cobre polido | 6000K |
| 4874 | polido | | 4875 | polido | | 4993 | polido | |
| 876 | cobre polido | | 883 | branco | | 895 | branco | |
| 878 | dourado polido | 6000K | 885 | cobre polido | 6000K | 896 | cobre polido | 6000K |
| 880 | preto | | 890 | dourado polido | | 900 | dourado polido | |
| 4989 | branco | | 4991 | polido | | 902 | preto | |
| 4990 | polido | | 892 | preto | | 4903 | polido | |



cód. 736/35
• 36 watts – bivolt
• 2700 lumens

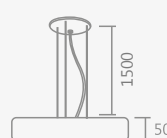

cód. 736/50
• 50 watts – bivolt
• 3750 lumens

PLAFONS

| ID | COR | LED | ID | COR | LED |
|------|--------|-------|------|--------|-------|
| 4995 | polido | 3000K | 4998 | polido | 3000K |
| 4996 | polido | 6000K | 4999 | polido | 6000K |

PENTENTES

| ID | COR | LED | ID | COR | LED |
|------|----------------|-------|------|----------------|-------|
| 903 | branco | 3000K | 911 | branco | 3000K |
| 905 | cobre polido | | 913 | cobre polido | |
| 4994 | dourado polido | | 4997 | dourado polido | |
| 908 | preto | 6000K | 916 | preto | 6000K |
| 904 | branco | | 912 | branco | |
| 906 | cobre polido | | 914 | cobre polido | |
| 907 | dourado polido | 6000K | 915 | dourado polido | 6000K |
| 909 | preto | | 917 | preto | |



linha smart



385 – plafon smart



386 – pendente smart

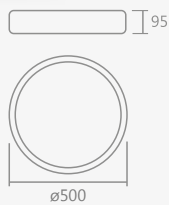
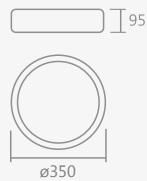
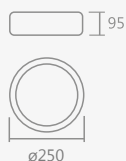

cód. 385/2

• 2 soquetes E27

cód. 385/3

• 3 soquetes E27

cód. 385/5

• 5 soquetes E27

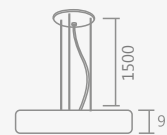

cód. 386/3

• 3 soquetes E27

cód. 386/5

• 5 soquetes E27

| ID | COR |
|------|----------------|
| 84 | branco |
| 85 | café |
| 86 | cobre polido |
| 88 | dourado polido |
| 90 | preto |
| 3214 | dourado ono |
| 3215 | cobre ono |
| 4704 | polido |

| ID | COR |
|------|----------------|
| 97 | branco |
| 98 | café |
| 99 | cobre polido |
| 101 | dourado polido |
| 103 | preto |
| 4706 | polido |
| 4722 | dourado ono |
| 5000 | cobre ono |

| ID | COR |
|------|----------------|
| 110 | branco |
| 111 | café |
| 112 | cobre polido |
| 2205 | dourado polido |
| 116 | preto |
| 3766 | dourado ono |
| 5061 | cobre ono |
| 4902 | polido |

| ID | COR |
|------|----------------|
| 122 | branco |
| 123 | café |
| 124 | cobre polido |
| 126 | preto |
| 3538 | dourado polido |
| 126 | preto |
| 5004 | polido |
| 3211 | dourado ono |
| 5005 | cobre ono |

| ID | COR |
|------|----------------|
| 131 | branco |
| 132 | café |
| 133 | cobre polido |
| 3537 | dourado polido |
| 135 | preto |
| 5001 | polido |
| 5002 | dourado ono |
| 5003 | cobre ono |



linha panamera



100



693/1 – pendente panamera

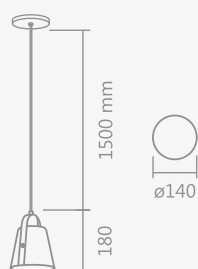

- 1 soquete E27

| ID | COR |
|------|--------------------|
| 616 | preto/cobre ono |
| 621 | branco/dourado ono |
| 3765 | preto |



693/3 – pendente panamera buque

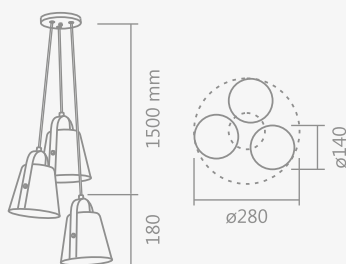

- 3 soquetes E27

| ID | COR |
|------|--------------------|
| 642 | preto/cobre ono |
| 5011 | branco/cobre ono |
| 3063 | branco/dourado ono |
| 639 | preto |



693/3 – pendente panamera trilho

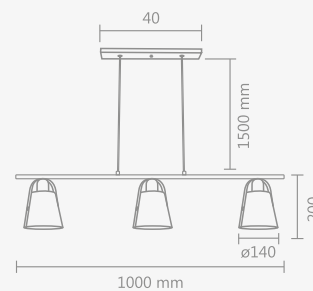

- 3 soquetes E27

| ID | COR |
|------|--------------------|
| 643 | preto/cobre ono |
| 5008 | branco/dourado ono |
| 649 | preto |

linha ellos



709/1 – arandela ellos

• 1 soquete E27



| ID | COR |
|------|----------------------------|
| 716 | branco |
| 718 | branco/cobre eletrostatico |
| 719 | branco/cobre ono |
| 725 | preto |
| 728 | preto/cobre ono |
| 729 | preto/cobre polido |
| 730 | preto/dourado ono |
| 1656 | branco/dourado ono |
| 1657 | preto/cobre eletrostatico |
| 1863 | preto/cobre lixado |
| 1994 | preto/cobre eletrostatico |
| 2566 | branco/dourado ono |
| 2573 | preto/ dourado polido |
| 2640 | branco/dourado polido |
| 3034 | branco/dourado lixado |
| 4698 | branco/cobre polido |



101

linha astra



727/1 – arandela astra

• 1 soquete E27

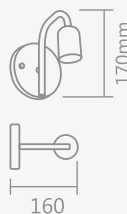

| ID | COR |
|------|---------------------------|
| 820 | branco |
| 821 | branco/cobre polido |
| 824 | cobre polido |
| 828 | dourado ono |
| 829 | preto |
| 831 | preto/cobre eletrostatico |
| 832 | preto/cobre polido |
| 833 | preto/dourado ono |
| 834 | preto/dourado polido |
| 836 | dourado polido |
| 2200 | branco/dourado polido |
| 2491 | polido |
| 2575 | preto/cobre ono |
| 2822 | branco/cobre ono |

linha kamilla



432/1 – pendente kamilla



432/4 – pendente kamilla trilho



449/1 – coluna kamilla

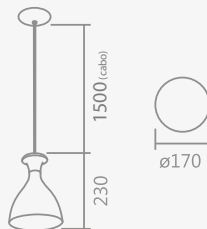

• 1 soquete E27

| ID | COR |
|------|----------------------------|
| 217 | lixado/branco |
| 218 | preto/branco |
| 2954 | dourado lixado/dourado ono |
| 3731 | branco |
| 5013 | preto |

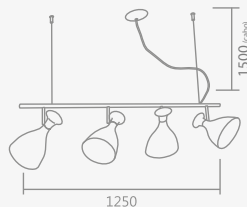

• 4 soquetes E27

| ID | COR |
|------|----------------------------|
| 220 | branco/dourado ono |
| 227 | preto/branco |
| 228 | preto/dourado ono |
| 223 | dourado lixado/dourado ono |
| 2240 | branco |
| 2468 | preto |

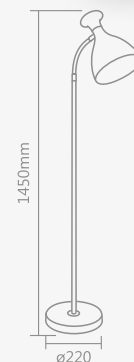

• 1 soquete E27

| ID | COR |
|------|----------------------------|
| 263 | lixado/branco |
| 265 | preto/branco |
| 267 | preto/dourado ono |
| 3677 | dourado lixado/dourado ono |
| 5015 | branco |
| 2028 | preto |

linha empire



103



655/4 – pendente empire



655/6 – pendente empire

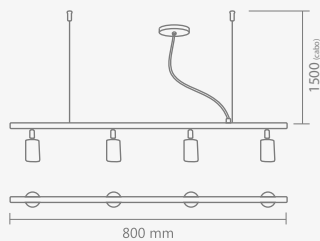

• 4 soquetes E27

| ID | COR |
|------|--------------------|
| 461 | cobre polido |
| 462 | dourado lixado |
| 463 | dourado onô |
| 464 | dourado polido |
| 466 | preto |
| 467 | preto/cobre polido |
| 2344 | cobre lixado |

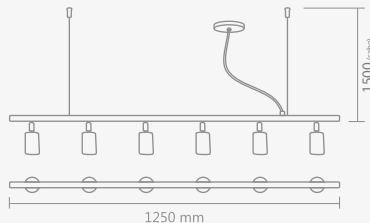

• 6 soquetes E27

| ID | COR |
|-----|--------------------|
| 468 | cobre polido |
| 469 | dourado lixado |
| 470 | dourado onô |
| 471 | dourado polido |
| 473 | preto |
| 474 | preto/cobre polido |

linha drop



104



757/1 – arandela drop



765/1 – luminária de mesa drop

• 1 globo vidro leitoso \varnothing 120mm – 1 x G9

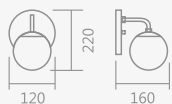

| ID | COR |
|------|----------------|
| 965 | branco |
| 966 | cobre onô |
| 967 | cobre polido |
| 968 | dourado onô |
| 969 | preto |
| 971 | dourado polido |
| 3193 | polido |

• 1 globo vidro leitoso \varnothing 100mm – 1 x G9

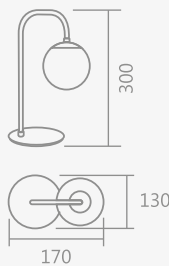

| ID | COR |
|-----|----------------|
| 983 | azul |
| 984 | branco |
| 985 | cobre polido |
| 986 | dourado onô |
| 987 | dourado polido |
| 988 | preto |
| 989 | rosa |

linha tiger



689/1 – pendente tiger

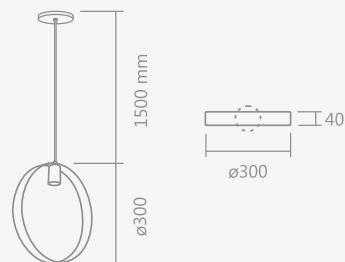

- 1 soquete E27

| ID | COR |
|------|----------------------------|
| 594 | branco/cobre eletrostatico |
| 595 | branco/cobre ono |
| 596 | branco/dourado ono |
| 598 | dourado ono |
| 600 | preto |
| 602 | preto/cobre eletrostatico |
| 2564 | branco/dourado ono |
| 4802 | branco |



linha vitara



688/1 – pendente vitara

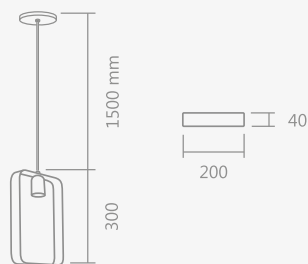

- 1 soquete E27

| ID | COR |
|------|---------------------------|
| 588 | branco/cobre ono |
| 589 | branco/dourado ono |
| 591 | preto |
| 593 | preto/cobre eletrostatico |
| 2351 | branco |
| 2567 | branco/dourado ono |



665/1 – luminária de mesa city

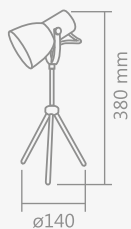

• 1 soquete E27

| ID | COR |
|-----|----------------------|
| 513 | branco/cobre polido |
| 516 | cobre polido |
| 518 | dourado polido |
| 521 | preto |
| 522 | preto/cobre polido |
| 523 | preto/dourado polido |



666/1 – coluna city



• 1 soquete E27

| ID | COR |
|-----|-----------------------|
| 524 | branco/cobre polido |
| 525 | branco/dourado polido |
| 528 | preto |
| 530 | preto/cobre polido |
| 531 | preto/dourado polido |

linha dix



645/1 – luminária de mesa dix

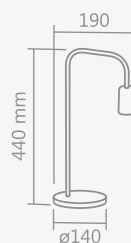

- 1 soquete E27

| ID | COR |
|------|----------------|
| 388 | cobre lixado |
| 389 | cobre polido |
| 391 | dourado polido |
| 392 | lixado |
| 393 | preto |
| 1916 | dourado lixado |



107

linha denver



647/1 – coluna denver

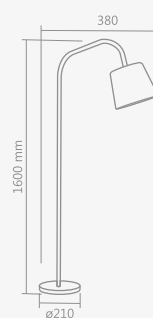

- 1 soquete E27

| ID | COR |
|-----|-----------------------|
| 413 | preto/branco |
| 414 | branco |
| 416 | branco/dourado onô |
| 417 | cobre polido/branco |
| 420 | dourado polido/branco |
| 423 | polido/branco |
| 424 | preto |

linha oxford



632/1 – pendente oxford



651/1 – coluna oxford



• 1 soquete E27

| ID | COR |
|------|---------------------|
| 320 | cobre polido |
| 324 | preto |
| 325 | preto/cobre polido |
| 2492 | branco/cobre polido |

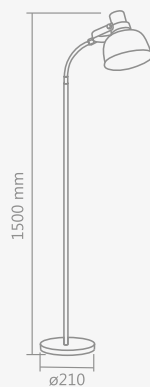

• 1 soquete E27

| ID | COR |
|-----|-------------------------------|
| 442 | branco brilhante/cobre polido |
| 443 | branco/cobre polido |
| 450 | preto |
| 451 | preto/cobre polido |



linha zeus



480/1 – spot base zeus

- 1 soquete GU10/MR16

| ID | COR |
|-----|--------------|
| 281 | branco |
| 282 | cobre lixado |
| 285 | lixado |
| 286 | preto |



480/2 – spot trilho zeus

- 2 soquetes GU10/MR16

| ID | COR |
|-----|--------------|
| 287 | branco |
| 288 | cobre lixado |
| 289 | lixado |
| 290 | preto |

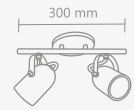

480/3 – spot trilho zeus

- 3 soquetes GU10/MR16

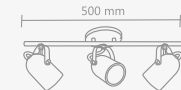

| ID | COR |
|-----|--------------|
| 291 | branco |
| 293 | cobre lixado |
| 294 | lixado |
| 295 | preto |

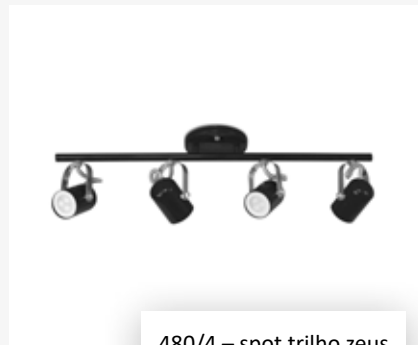

480/4 – spot trilho zeus

- 4 soquetes GU10/MR16

| ID | COR |
|------|--------------|
| 297 | cobre lixado |
| 298 | preto |
| 3826 | branco |
| 4072 | lixado |



109

linha globo



383/1 – spot base globo

- 1 soquete E27

| ID | COR |
|----|--------|
| 65 | branco |
| 66 | café |
| 67 | preto |

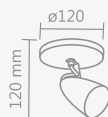

383/2 – spot base globo

- 2 soquetes E27

| ID | COR |
|----|--------|
| 69 | branco |
| 71 | café |
| 73 | preto |



linha flex



418/1 – spot base flex



- 1 soquete E27

| ID | COR |
|------|---------------------|
| 175 | branco |
| 176 | branco/cobre lixado |
| 178 | lixado |
| 179 | preto |
| 2135 | preto/cobre polido |
| 2347 | branco/cobre polido |



418/2 – spot trilho flex



- 2 soquetes E27

| ID | COR |
|------|---------------------|
| 180 | branco |
| 184 | preto |
| 185 | preto/cobre polido |
| 2346 | branco/cobre polido |
| 3053 | preto/cobre polido |
| 3054 | branco/cobre polido |



418/3 – spot trilho flex

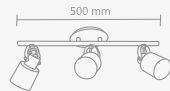

- 3 soquetes E27

| ID | COR |
|------|-----------------------|
| 186 | branco |
| 187 | branco/cobre lixado |
| 189 | branco/dourado polido |
| 192 | preto |
| 193 | preto/cobre lixado |
| 194 | preto/cobre polido |
| 2701 | branco/cobre polido |



418/4 – spot trilho flex



- 4 soquetes E27

| ID | COR |
|------|---------------------|
| 195 | branco |
| 196 | branco/cobre lixado |
| 199 | preto |
| 200 | preto/cobre polido |
| 3218 | branco/cobre polido |



110

linha tróia



658/1 – spot base tróia



- 1 soquete E27

| ID | COR |
|------|-------------------------------|
| 476 | branco brilhante/cobre polido |
| 480 | preto/cobre polido |
| 2742 | preto |



658/2 – spot trilho tróia

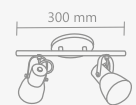

- 2 soquetes E27

| ID | COR |
|------|-------------------------------|
| 482 | branco brilhante/cobre polido |
| 485 | preto trilho |
| 486 | preto/cobre polido |
| 2744 | branco/cobre onô |



658/3 – spot trilho tróia

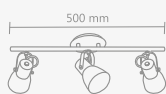

| | ID | COR |
|------------------|-----|-------------------------------|
| • 3 soquetes E27 | 487 | branco brilhante/cobre polido |
| | 491 | preto |
| | 493 | preto/cobre polido |



658/4 – spot trilho tróia

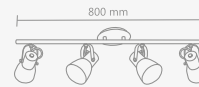

| | ID | COR |
|------------------|------|-------------------------------|
| • 4 soquetes E27 | 496 | branco brilhante/cobre polido |
| | 499 | preto/cobre polido |
| | 2358 | preto |

linha usina



376/1 – spot usina



| | ID | COR |
|-----------------|----|------------------|
| • 1 soquete E27 | 15 | branco brilhante |
| | 16 | café |
| | 19 | preto |



376/2 – spot usina



| | ID | COR |
|------------------|----|--------|
| • 2 soquetes E27 | 21 | branco |
| | 23 | café |
| | 29 | preto |



376/3 – spot trilho usina

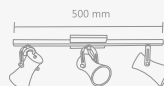

| | ID | COR |
|------------------|------|------------------|
| • 3 soquetes E27 | 30 | branco brilhante |
| | 31 | café |
| | 34 | preto |
| | 1998 | cobre |

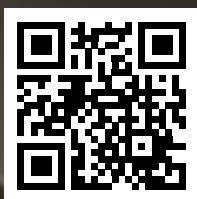

Leia o QR Code acima para acessar nosso site.
www.spotline.com.br

spotline
iluminação

Av. Cangaíba, 5013- São Paulo- SP- CEP 03711-011
Telefones: 11 2621-3211 | 2621-1703 | 2621-5680

vendas@spotline.com.br

[f /spotlineiluminacao](https://www.facebook.com/spotlineiluminacao) [@/spot_line_iluminacao](https://www.instagram.com/spot_line_iluminacao)