

# STU udio ucee



Catálogo 2023

vestir  
espaços  
de luz,  
design  
e emoção.

Acreditamos na importância de iluminar espaços com originalidade, por isso, investimos cada vez mais no desenvolvimento de soluções exclusivas que entregam, além do design, emoções através da luz.

O time de Pesquisa & Desenvolvimento da Studioluce trabalha em sintonia com referências e tendências internacionais, garantindo as melhores soluções em iluminação decorativa.

## **STUDIOLUCE**

Em 07 de abril de 1995, atuando como fábrica de luminárias decorativas de alto padrão com direção criativa dos designers Toni e Marco Dias, começa a história da Studioluce. Referência em qualidade e design, por inúmeras vezes foi reconhecida pela excelência e recebeu prêmios como: Prêmio Design MCB, conferido pelo Museu da Casa Brasileira, Prêmio Abilux Design de Luminárias e o renomado prêmio internacional iF Design Award, entre outros.

A partir de 2007, a Studioluce – mantendo sua missão na fabricação de luminárias – passa a integrar o Grupo Newline, e nesse período foi responsável por iluminar vários edifícios ícones da arquitetura contemporânea como os hotéis Hilton, Sheraton, Transamérica, Emiliano, Renaissance e Unique, além dos hospitais Albert Einstein e Sírio Libanês, na capital paulista.

Em 2012, iniciamos a atuação no desenvolvimento e criação de luminárias importadas garantindo qualidade e acabamento diferenciados das peças e essa visão e cuidado nos trouxe até aqui.

Hoje a Studioluce conta com um portfólio com mais de 1.000 soluções em iluminação decorativa. Além de pendentes, arandelas, plafons e abajures que entregam luz aos espaços. Nossos produtos levam design e identidade por meio da iluminação disruptiva.

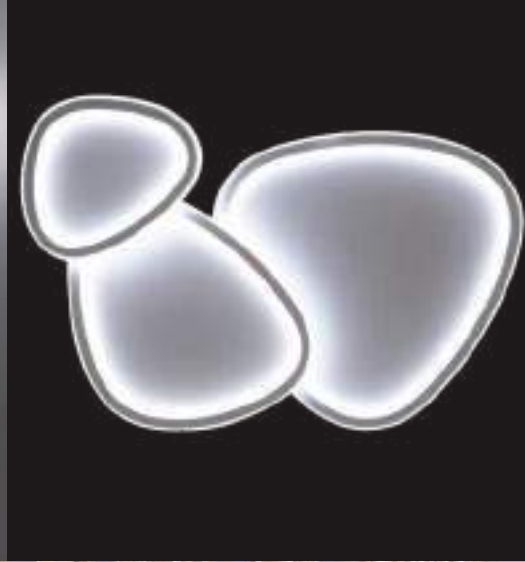



## **SHOWROOM**

O Showroom Studioluce – instalado em um espaço de 1.000m<sup>2</sup>, distribuídos em 3 pavimentos – fica em São Paulo, próximo ao Aeroporto de Congonhas em um local de fácil acesso. Idealizado como um espaço de experiência, o showroom está sempre preparado para receber clientes e parceiros tanto para workshops, treinamentos e eventos, quanto para um simples café e um bate papo.

No rooftop, um amplo espaço Gourmet funcional foi idealizado para tornar a experiência ainda mais agradável aos visitantes; aliando toda experiência com um toque sensorial que nos convida a saborear a vida com mais calma.

Endereço: Rua Guaraiúva, 447 - Brooklin - São Paulo - SP.  
CEP: 04569-000



## **CENTRO DE DISTRIBUIÇÃO**

Localizado em Suzano, o centro de distribuição da Studioluca fica próximo ao escritório de operações, garantindo agilidade e eficiência nos processos de abastecimento e logística.



# NOVA COLEÇÃO 2023

Com o propósito de vestir ambientes de luz, design e emoção, a Coleção 2023 Studiolute, reflete a força, elegância e beleza do Feminino. São mais de 100 novas peças que imprimem originalidade e elegância, assim como nossa fonte de inspiração.



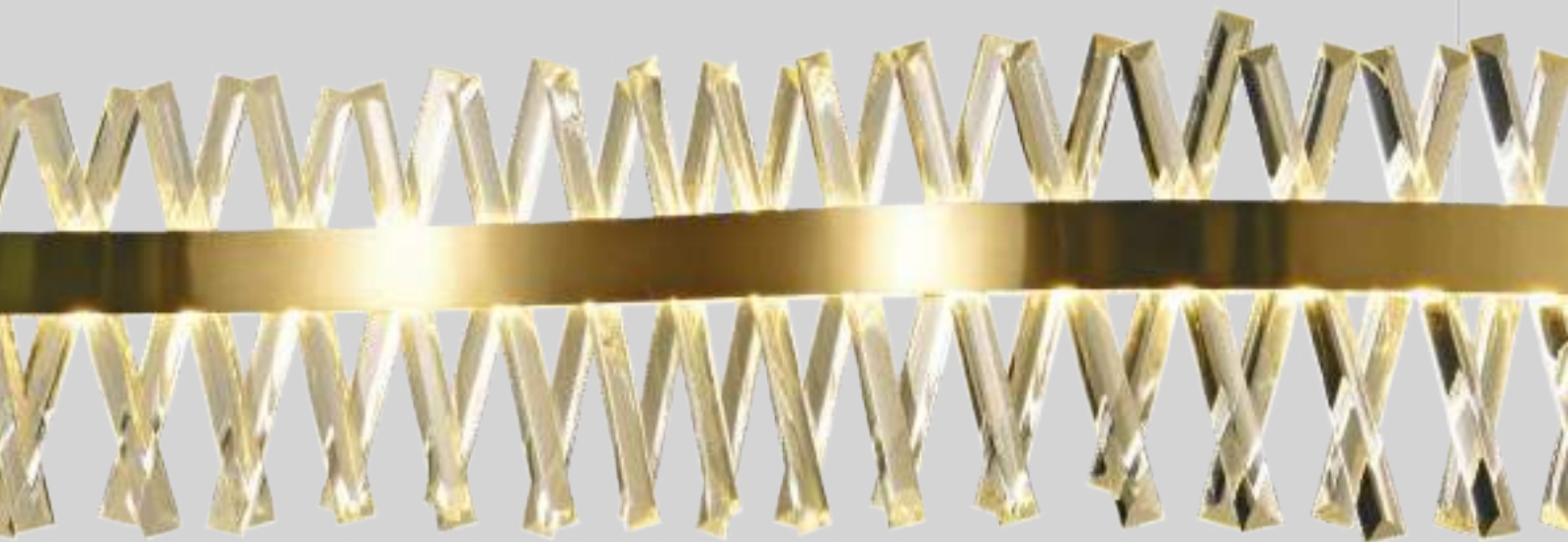



# INDEX

alfabético

Allure	221	Castillo	113	Fusion	223
Alma	35	Cissy	185	Gaia	71
Anello	177	Clam	375	Gali	131
Anello Oval	181	Classic	381	Globe	435
Aniko	406	Cloud	331	Haken	115
Antik	139	Cloud II	329	Halter	448
Arrow	429	Cluster	430	Hamar	420
Asha	259	Coco	53	Haus	407
Askin	411	Colli	289	Hazel	133
Atenas	159	Cora	45	Helmet	419
Atlas	25	Cosmos	275	Hilton	383
Atomy	277	Cover	447	Hook	313
Auê	83	Cozy	405	Hoop	247
Augen	392	Crown	111	Horn	421
Aura	271	Cúpulas de Abajur	479	Hort	19
Avis	253	Cutie	369	Hort	107
Baba	51	Deja Vu	82	Horus	130
Balka	183	Dengo	85	Hunt	280
Bases de Abajur	463	Deuce	361	Indira	95
Bead	364	Diamond	121	Ivory	437
Beaver	413	Disco	55	Jadore	135
Bergen	415	DNA	279	Jetty	372
Bergen	416	Dock	171	Jubile	443
Berla	261	Dome	394	Kane	355
Bert	229	Dover	257	Kiev	433
Blade	191	Drain	395	Kira	251
Blasen	273	Drain Office	401	Kon	93
Blur	129	Drip	373	Kono	454
Bol	57	Dublin	377	Krio	451
Brande	417	Dupe	263	Lace	243
Cadre	357	Eclipse	217	Lamar	49
Cálico	379	Eden	371	Lamu	345
Calla	255	Fita	77	Lance	165
Candela	33	Flint	455	Lanciato	21
Cannon	203	Frida	41	Land	105
Canopla Slim	499	Friso	75	Laticius	125
Carlota	11	Full Moon	333	Lina	34

Linse	391	Orbit II	303	Tagne	246
Lockup	441	Orbit Mondri	317	Tarta	13
Lolly	339	Orgon	241	Tear	374
Lorum	167	Orla	452	Tera	343
Ludo	209	Passo	74	Tine	436
Luft	264	Pectus	215	Tint	456
Lune	163	Pellet	385	Toak	101
Luxor	117	Pilz	91	Tomie	31
Lynus	119	Pinot	281	Tonton	89
Malala	47	Pipe	409	Torch	431
Mali	15	Plyn	337	Torchia	367
Mallen	225	Post	449	Trace	432
Manner	440	Poti	92	Traço	37
Maré	66	Potter	457	Trento	387
Maya	127	Prince	17	Triplet	353
Mia	87	Quebec	235	Turret	460
Mimo	81	Rafik	231	Twine	245
Mini Moon	346	Ravelo	365	Twist	213
Mizo	453	Ricci	269	Valley	63
Mob	265	Ritz	219	Vega	393
Mobile	50	Roof	410	Vermont	344
Modular Magnetic System	482	Rustic	97	Verona	462
Montreal	239	Sears	205	Versa	157
Moon	347	Shell	99	Véu	29
Muvuca	39	Sicília	461	Vision	408
Namastê	27	Sion	137	Volpi	249
Neolus	287	Sling	444	Volta	65
Netz	161	Somut	445	Wala	173
Nexus	418	Sonik	211	Worm	244
Nice	439	Sophi	141	Zavo	169
Nó	23	Space	267	Zenet	109
Numa	67	Spine	427	Zione	195
Ohana	335	Spire	386	Zuzu	88
Onda	79	Spring	378		
Onde	73	Spy	315		
Onna	59	Suez	143		
Orbit	293	Tack	459		

# Carlota

Metal e Alumínio | Cristal | Dourado e Transparente

LANÇAMENTO • 2023



Detalhe da peça



Arandela • **AR1804**

2XG9 | 10W MAX  
C155XL230XA350mm  
Bivolt

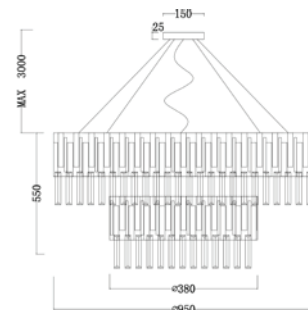

Cabo ajustável até 3000mm

Pendente • **PD1806**

19XG9 | 95W MAX  
D950XA550mm  
Bivolt

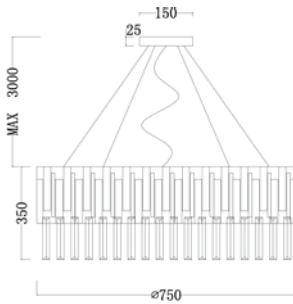

Cabo ajustável até 3000mm



Pendente • **PD1805**

10XG9 | 50W MAX  
D750XA350mm  
Bivolt

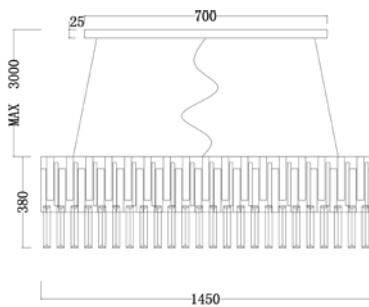

Cabo ajustável até 3000mm



Pendente • **PD1882**

14XG9 | 70W MAX  
C1450XL300XA380mm  
Bivolt

# Tarta

Metal Vidro | Dourado fosco

LANÇAMENTO • 2023



Detalhe da peça



Pendente • **PD1730**

12XG9 | 60W MAX  
C1000XL350XA400mm  
Bivolt

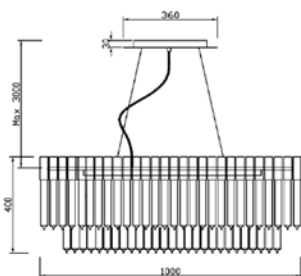

Cabo ajustável até 3000mm



PD1730

# Mali

Metal | Vidro | Dourado e Transparente



Detalhe da peça

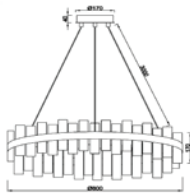

Cabo ajustável até 3000mm



Pendente • **PD1799**

1XLED | 53W | 3710LM | 2700K  
D800XA170mm  
Bivolt

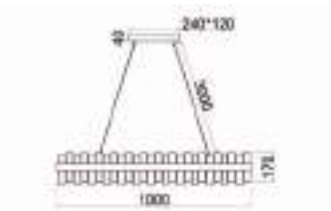

Cabo ajustável até 3000mm



Pendente • **PD1800**

1XLED | 52W | 3640LM | 2700K  
C1000XL300XA170mm  
Bivolt



PD1799



# Prince

Metal | Vidro | Dourado e Transparente

LANÇAMENTO • 2023



Detalhe da peça



Pendente • **PD1773**

22XG9 | 110W MAX  
D700XA450mm  
Bivolt

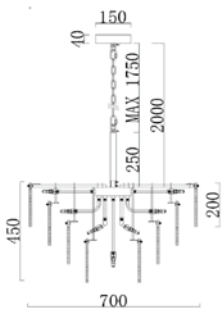

Cabo ajustável até 2000mm



Detalhe da peça



Pendente • **PD1774**

16XG9 | 80W MAX  
C1000XL300XA300mm  
Bivolt

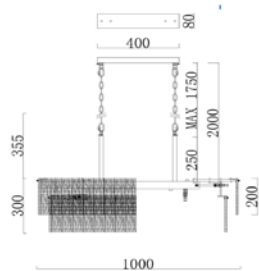

Cabo ajustável até 2000mm

# Hort

Metal | Vidro | Bronze e Transparente

LANÇAMENTO • 2023



Detalhe da peça

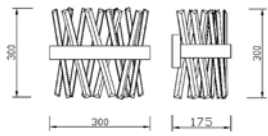

Arandela • **AR1783**

4XG9 | 20W MAX  
C300XL175XA300mm  
Bivolt

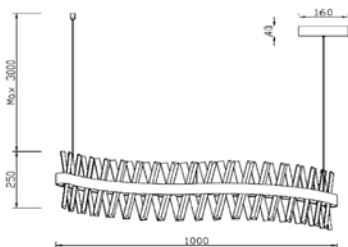

Cabo ajustável até 3000mm



Pendente • **PD1784**

1XLED | 50W | 3500LM | 3000K  
C1000XL160XA250mm  
Bivolt



PD1784

# Lanciato

Metal | Cristal | Dourado e Transparente

LANÇAMENTO • 2023



Detalhe da peça



Cabo ajustável até 3000mm



Pendente • **PD1767**

1XLED | 20W | 1600LM | 3000K  
C1200XL36XA76mm  
Bivolt



Cabo ajustável até 3000mm



Pendente • **PD1768**

1XLED | 12W | 1020LM | 3000K  
L76XA600mm  
Bivolt



Cabo ajustável até 3000mm



Pendente • **PD1769**

1XLED | 20W | 1600LM | 3000K  
L76XA1200mm  
Bivolt



PD1767

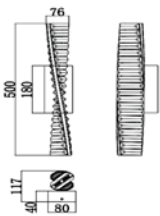

Arandela • **AR1770**

1XLED | 10W | 800LM | 3000K  
C80XL117XA500mm  
Bivolt

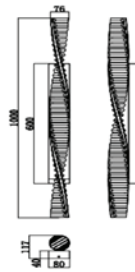

Arandela • **AR1771**

1XLED | 20W | 1600LM | 3000K  
C80XL117XA1000mm  
Bivolt

# Nó

Metal | Cristal | Dourado e Transparente Fosco

LANÇAMENTO • 2023



Detalhe da peça

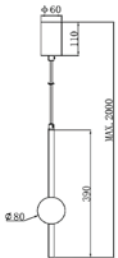

Cabo ajustável até 2000mm



Pendente • **PD1637**

1XLED | 4W | 300LM | 2700K  
D80XA390mm  
Bivolt



Pendente • **PD1819**

3XLED | 12W | 900LM | 2700K  
C800XL80XA600mm  
Bivolt

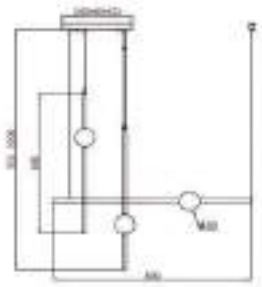

Cabo ajustável até 3000mm





PD1819



# Atlas

Metal | Acrílico | Dourado e Transparente

LANÇAMENTO • 2023



Detalhe da peça



**FORA DE LINHA**

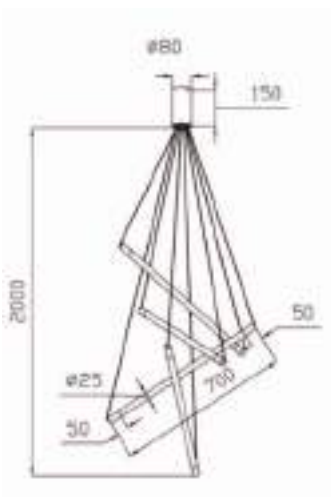

Cabo ajustável até 3000mm

Pendente • PD1772 **FORA DE LINHA**

1XLED | 30W | 2100LM | 3000K  
D700XA700mm  
Bivolt



PD1772

# Namastê

Metal | Acrílico | Dourado e Transparente

LANÇAMENTO • 2023



Detalhe da peça

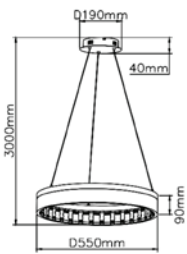

Cabo ajustável até 3000mm



Pendente • **PD1792**

1XLED | 30W | 1500LM | 3000K  
D550XA90mm  
Bivolt

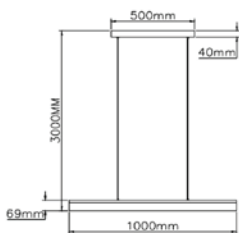

Cabo ajustável até 3000mm



Pendente • **PD1793**

1XLED | 30W | 1500LM | 3000K  
C1000XL15XA69mm  
Bivolt



PD1793

# Véu

\_DESIGN  
STUDIOLUCE

Metal | Acrílico | Dourado e Transparente

LANÇAMENTO • 2023



Detalhe da peça

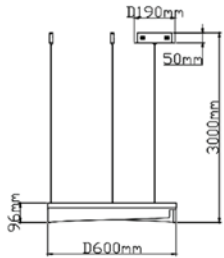

Cabo ajustável até 3000mm



Pendente • **PD1790**

1XLED | 42W | 2100LM | 3000K  
D600XA96mm  
Bivolt

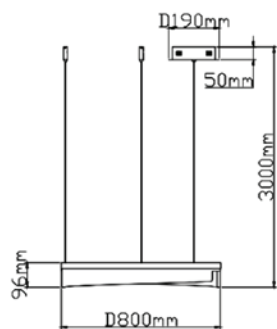

Cabo ajustável até 3000mm



Pendente • **PD1791**

1XLED | 50W | 2500LM | 3000K  
D800XA96mm  
Bivolt

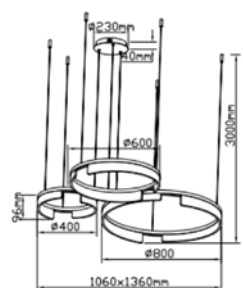

Cabo ajustável até 3000mm



Pendente • **PD1789**

1XLED | 89W | 4450LM | 3000K  
C1360XL1060XA96mm  
Bivolt



PD1789

# Tomie

\_DESIGN  
STUDIOLUCE

Metal | Acrílico | Dourado ou Grafite



Detalhe da peça

PRODUTOS INSTALADOS INDIVIDUALMENTE.  
POSSIBILITA DIFERENTES COMPOSIÇÕES.



Pendente • PD1808

1XLED | 37W | 2015LM | 3000K  
C970XL280XA73mm  
Bivolt

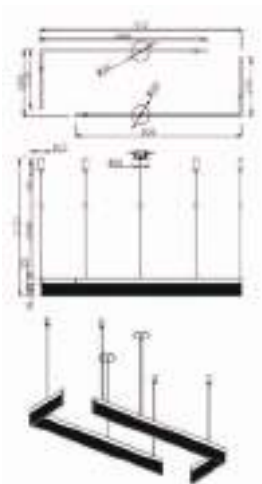

Cabo ajustável até 3000mm

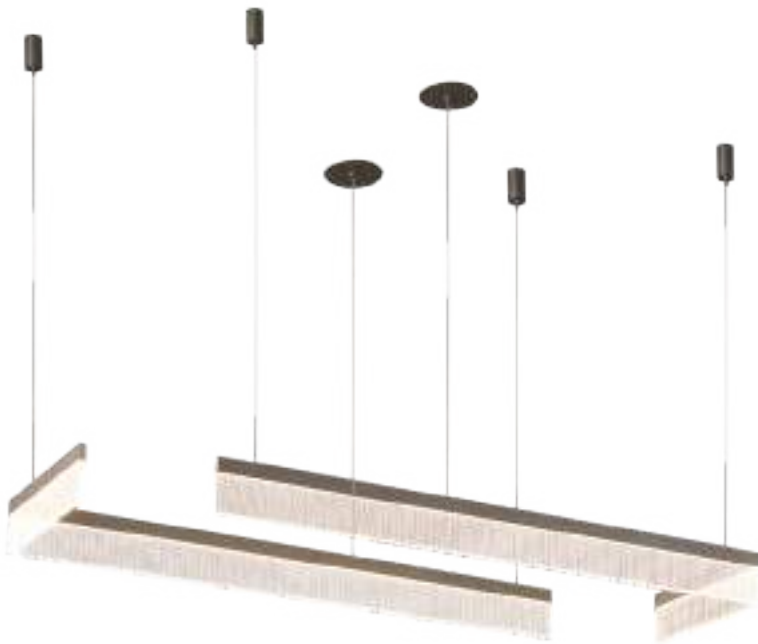

Pendente • PD1808GR

1XLED | 37W | 2015LM | 3000K  
C970XL280XA73mm  
Bivolt



PD1808



# Candela

\_DESIGN  
STUDIOLUCE

Metal | Acrílico | Grafite e Transparente



Detalhe da peça



Pendente • **PD1859**

1XLED | 49W MAX | 4400LM | 3000K  
D700XA65mm  
Bivolt



Cabo ajustável até 3000mm



PD1859

# Lina

Metal | Acrílico | Dourado e Transparente



Detalhe da peça



Pendente • **PD1795**

1XLED | 24W | 1920LM | 3000K  
C1185XL20XA67mm  
Bivolt



Cabo ajustável até 3000mm



# Alma

\_DESIGN  
STUDIOLUCE

Metal | Acrílico | Dourado e Transparente

LANÇAMENTO • 2023



Detalhe da peça

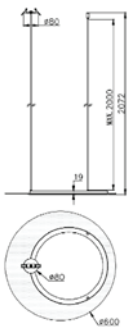

Cabo ajustável até 2000mm



Pendente • **PD1809**

1XLED | 38W | 3100LM | 3000K  
D600XA19mm  
Bivolt

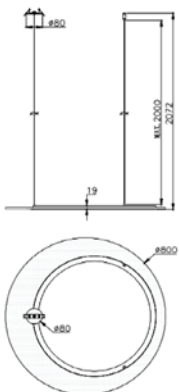

Cabo ajustável até 2000mm



Pendente • **PD1810**

1XLED | 61W | 4900LM | 3000K  
D800XA19mm  
Bivolt

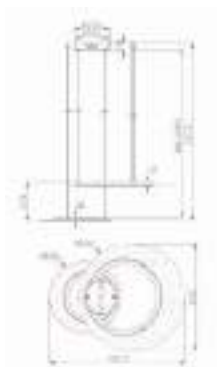

Cabo ajustável até 2000mm



Pendente • **PD1811**

1XLED | 58W | 4550LM | 3000K  
C600XL780XA19mm  
Bivolt



PD1811

# Traço

\_DESIGN  
STUDIOLUCE

Metal | Acrílico | Dourado e Transparente

LANÇAMENTO • 2023



Detalhe da peça

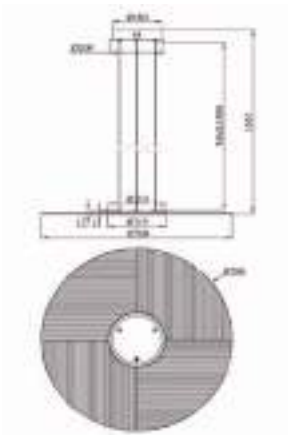

Cabo ajustável até 1500mm

Pendente • **PD1868**

1XLED | 18W | 1650LM | 3000K  
D700XA11mm  
Bivolt



Arandela • **AR1869**

1XLED | 6W | 530LM | 3000K  
D250XA11mm  
Bivolt

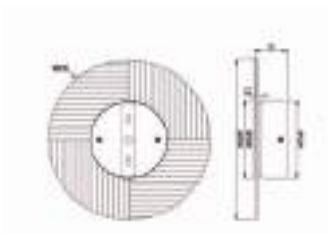



PD1868

# Muvuca

Metal | Vidro | Dourado e Branco

LANÇAMENTO • 2023

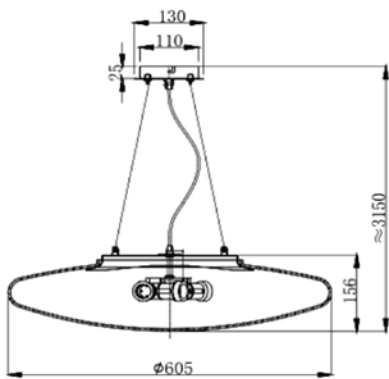

Cabo ajustável até 3000mm

Pendente ● **PD1801**

5XE27 | 200W MAX  
D605XA156mm  
Bivolt



PD1801



# Frida

\_DESIGN  
STUDIOLUCE

Metal | Alabastro | Dourado e Branco



Detalhe da peça



Arandela • **AR1824**

1XG9 | 5W MAX  
C100XL115XA170mm  
Bivolt



Pendente • **PD1825**

1XG9 | 5W MAX  
D60XA223mm  
Bivolt



Cabo ajustável até 2000mm

LANÇAMENTO • 2023



PD1825

# Frida

\_DESIGN  
STUDIOLUCE

Metal | Alabastro | Dourado e Branco

LANÇAMENTO • 2023



Detalhe da peça

POSSÍVEL INSTALAR  
DE DUAS FORMAS

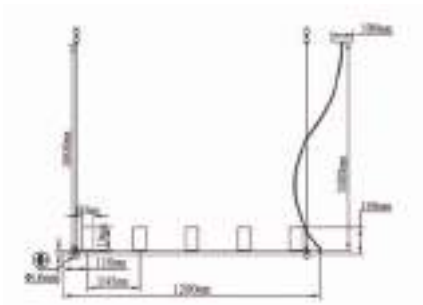

Cabo ajustável até 3000mm



Pendente • **PD1826**

5XG9 | 25W MAX | |  
C1200XL60XA140mm  
Bivolt

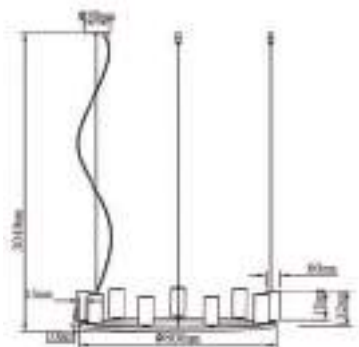

Cabo ajustável até 3000mm



Pendente • **PD1827**

9XG9 | 45W MAX  
D800XA132mm  
Bivolt



PD1827

# Cora

\_DESIGN  
STUDIOLUCE

Metal | Alabastro | Dourado e Branco

LANÇAMENTO • 2023



Detalhe da peça

INSTALAÇÃO DE EMBUTIR



AR1828

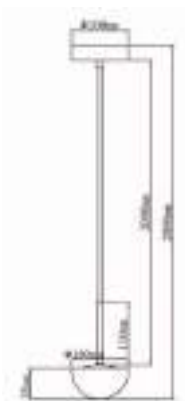
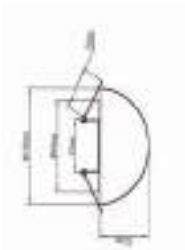

Cabo ajustável até 2000mm



Pendente • **PD1829**

1XLED | 3W | 210LM | 2700K  
D100XA165mm  
Bivolt



Arandela • **AR1828**

1XLED | 3W | 210LM | 2700K  
D100XA55mm  
Bivolt



Pendente • **PD1830**

7XLED | 21W | 1470LM | 2700K  
C1200XL100XA330mm  
Bivolt

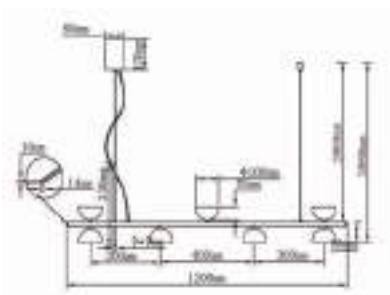

Cabo ajustável até 3000mm



# Malala

\_DESIGN  
STUDIOLUCE

Metal | Vidro | Preto ou Dourado

LANÇAMENTO • 2023

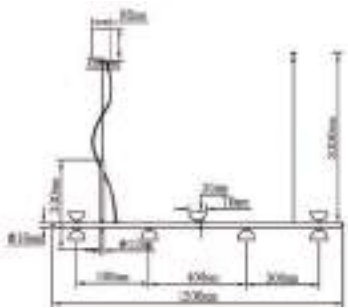

Cabo ajustável até 3000mm



Pendente • **PD1823PT**

7XLED | 21W | 1470LM | 2700K  
C1200XL70XA330mm  
Bivolt

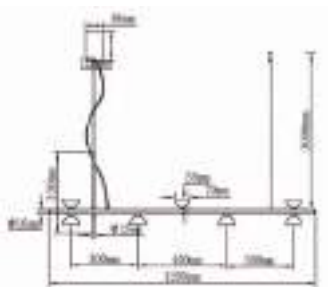

Cabo ajustável até 3000mm



Pendente • **PD1823DO**

7XLED | 21W | 1470LM | 2700K  
C1200XL70XA330mm  
Bivolt



PD1823PT



# Lamar

Metal | Acrílico | Preto e Dourado

LANÇAMENTO • 2023

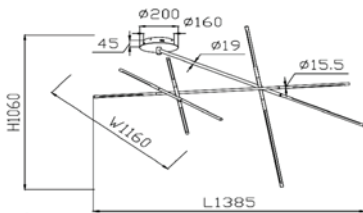

Plafon • **PL1665**

1XLED | 58W | 4060LM | 3000K  
C1385XL1160XA1060mm  
Bivolt



PL1665

# Mobile

Metal | Vidro Fosco | Dourado



Pendente • PD1807 **FORA DE LINHA**

6XG9 | 30W MAX  
D1360XA900mm  
Bivolt

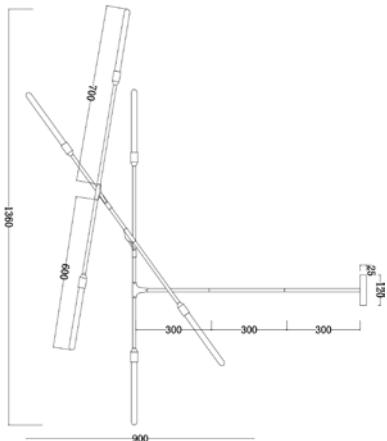

Cabo ajustável até 3 hastes de 30cm



# Baba

Metal | Acrílico | Preto, Branco ou Dourado

LANÇAMENTO • 2023

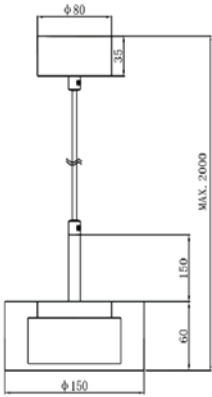

Cabo ajustável até 2000mm

PODE SER INSTALADO COMO  
PENDENTE OU PLAFON



Pendente / Plafon • **PD1782PT**

1XLED | 7W | 500LM | 3000K  
D150XL150XA60mm  
Bivolt



Pendente / Plafon • **PD1782BR**

1XLED | 7W | 500LM | 3000K  
D150XL150XA60mm  
Bivolt



Pendente / Plafon • **PD1782DO**

1XLED | 7W | 500LM | 3000K  
D150XL150XA60mm  
Bivolt



Pendente • **PD1820**

3XLED | 21W | 1500LM | 3000K  
C1080XL150XA85mm  
Bivolt

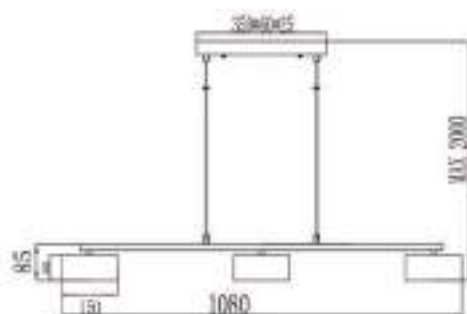

Cabo ajustável até 3000mm

# Coco

Metal | Acrílico | Preto e Dourado ou Fendi e Dourado

LANÇAMENTO • 2023



Cabo ajustável até 2000mm



Pendente • **PD1814PT**

1XLED | 12W | 300LM | 3000K  
D230XA205mm  
Bivolt



Pendente • **PD1814FD**

1XLED | 12W MAX | 300LM | 3000K  
D230XA205mm  
Bivolt



Pendente • **PD1815PT**

1XLED | 24W | 880LM | 3000K  
D400XA205mm  
Bivolt



Pendente • **PD1815FD**

1XLED | 24W MAX | 880LM | 3000K  
D400XA205mm  
Bivolt

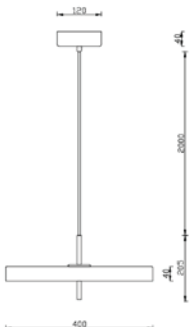

Cabo ajustável até 2000mm

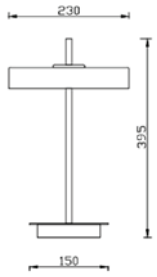

Cabo com 1500mm



Abajur • **AB1816PT**

1XLED | 12W | 300LM | 3000K  
D230XA395mm  
Bivolt



Abajur • **AB1816FD**

1XLED | 12W | 300LM | 3000K  
D230XA395mm  
Bivolt



PD1815FD

# Disco

Metal | Acrílico | Preto ou Dourado

LANÇAMENTO • 2023



Detalhe da peça



Pendente ● **PD1802DO**

1XLED | 7W | 560LM | 3000K  
D400XA161mm  
Bivolt



Pendente ● **PD1802**

1XLED | 7W | 560LM | 3000K  
D400XA161mm  
Bivolt

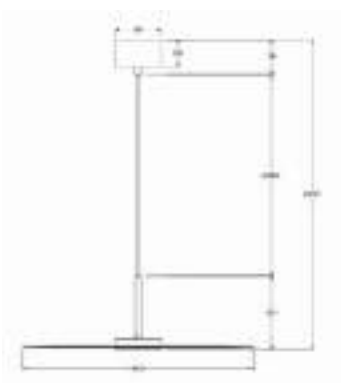

Cabo ajustável até 2000mm



PD1802



# Bol

Metal e Alumínio | Acrílico | Dourado e Transparente

LANÇAMENTO • 2023



Detalhe da peça

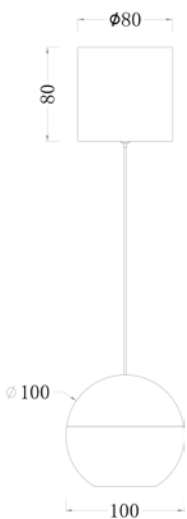

Cabo ajustável até 2000mm



Pendente • **PD1832DO**

1XLED | 10W MAX | 570LM | 3000K  
D100XA95mm  
Bivolt



PD1832DO

# Onna

Metal e Alumínio | Preto e Amadeirado ou Preto e Dourado

LANÇAMENTO • 2023

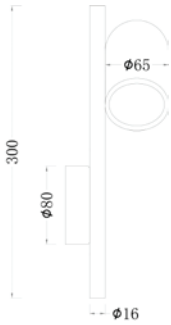

Arandela • **AR1834PTMD**

1XLED | 5W | 300LM | 3000K  
C125XL110XA300mm  
Bivolt



Arandela • **AR1834DOMD**

1XLED | 5W | 300LM | 3000K  
C125XL110XA300mm  
Bivolt

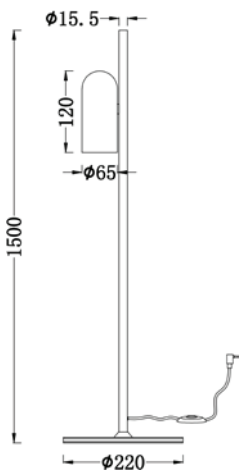

Coluna • **CL1837PTMD**

1XLED | 5W | 300LM | 3000K  
D220XA1500mm  
Bivolt



Coluna • **CL1837DOMD**

1XLED | 5W | 300LM | 3000K  
D220XA1500mm  
Bivolt

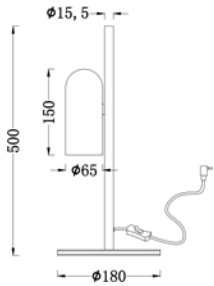

Cabo com 1800mm



Abajur • **AB1838PTMD**

1XLED | 5W | 300LM | 3000K  
D180XA500mm  
Bivolt



Abajur • **AB1838DOMD**

1XLED | 5W | 300LM | 3000K  
D180XA500mm  
Bivolt

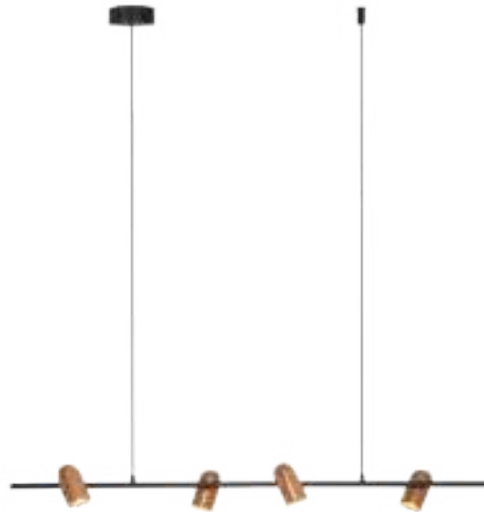

Pendente • **PD1835PTMD**

4XLED | 20W (4X5W) | 1200LM | 3000K  
C1390XL150XA120mm  
Bivolt



Pendente • **PD1835DOMD**

4XLED | 20W (4X5W) | 1200LM | 3000K  
C1390XL150XA120mm  
Bivolt

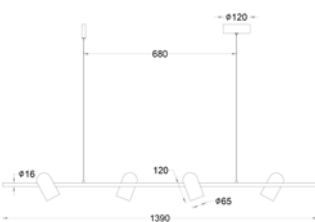

Cabo ajustável até 3000mm

# Onna

Metal e Alumínio | Preto e Amadeirado ou Dourado e Amadeirado



Detalhe da peça

LANÇAMENTO • 2023

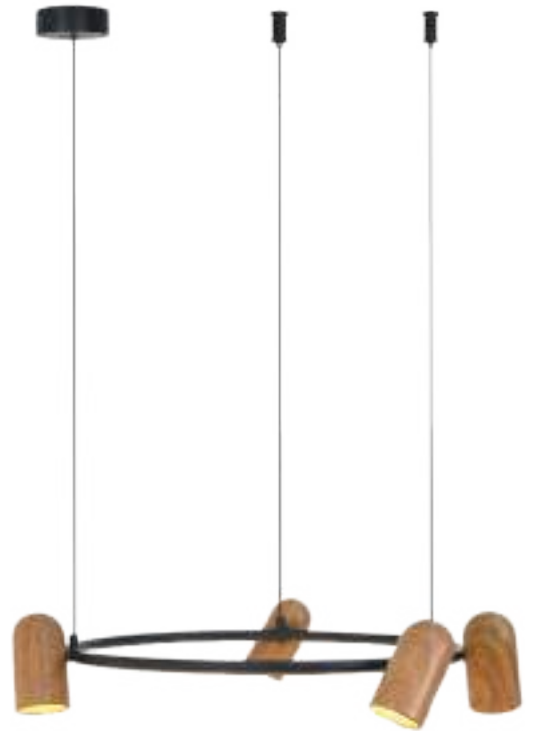

Pendente • **PD1836PTMD**

4XLED | 20W MAX | 1200LM | 3000K  
D660XA120mm  
Bivolt

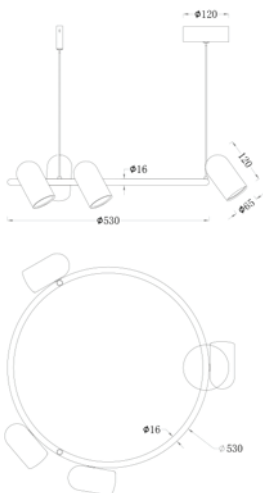

Cabo ajustável até 3000mm

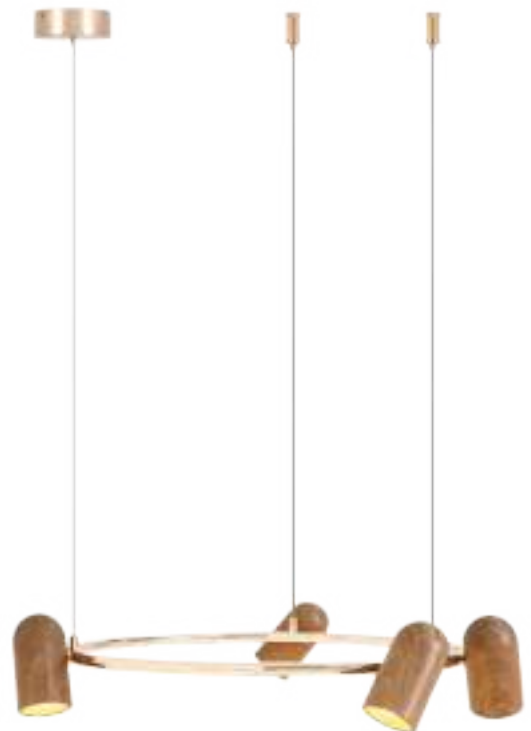

Pendente • **PD1836DOMD**

4XLED | 20W MAX | 1200LM | 3000K  
D660XA120mm  
Bivolt



PD1836PTMD

# Valley

Metal | Dourado, Preto ou Branco

LANÇAMENTO • 2023

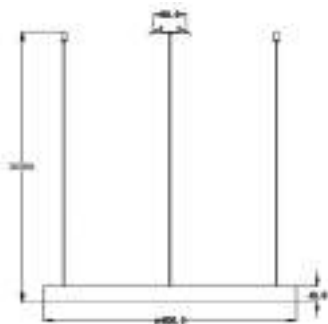

Cabo ajustável até 3000mm



Pendente • **PD1691DO**

1XLED | 32W | 1530LM | 3000K  
D600XA43mm  
Bivolt

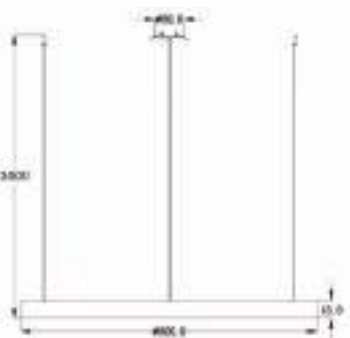

Cabo ajustável até 3000mm



Pendente • **PD1692DO**

1XLED | 40W | 2000LM | 3000K  
D800XA43mm  
Bivolt



Pendente • **PD1862DO**

1XLED | 30W | 1500LM | 3000K  
C1145XL400XA43mm  
Bivolt



Pendente • **PD1862BR**

1XLED | 30W | 1500LM | 3000K  
C1145XL400XA43mm  
Bivolt



Pendente • **PD1862PT**

1XLED | 30W | 1500LM | 3000K  
C1145XL400XA43mm  
Bivolt

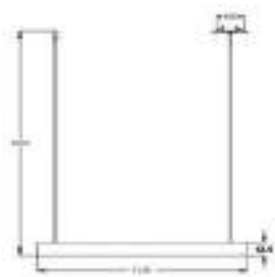

Cabo ajustável até 3000mm



PD1862DO



# Volta

Metal | Silicone | Preto ou Dourado

LANÇAMENTO • 2023

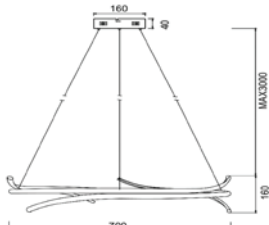

Cabo ajustável até 3000mm



Pendente • **PD1777PT**

1XLED | 36W | 2880LM | 3000K  
D700XA160mm  
Bivolt

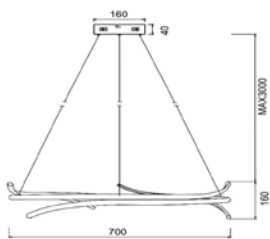

Cabo ajustável até 3000mm



Pendente • **PD1777DO**

1XLED | 36W | 2880LM | 3000K  
D700XA160mm  
Bivolt



PD1777PT

# Maré

Metal | Silicone | Branco ou Dourado

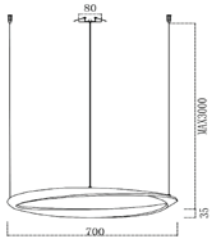

Cabo ajustável até 3000mm



Pendente • **PD1778BR**

1XLED | 27W | 2160LM | 3000K  
D700XA35mm  
Bivolt

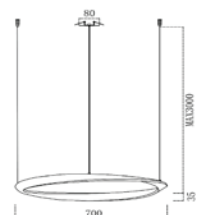

Cabo ajustável até 3000mm



Pendente • **PD1778DO**

1XLED | 27W | 2160LM | 3000K  
D700XA35mm  
Bivolt



PD1778DO

# Numa

Metal | Silicone | Dourado, Branco ou Preto

LANÇAMENTO • 2023



Pendente ● **PD1779PT**

1XLED | 27W | 2160LM | 3000K  
**D600**XA20mm  
 Bivolt

Pendente ● **PD1780PT**

1XLED | 36W | 2880LM | 3000K  
**D800**XA20mm  
 Bivolt

Pendente ● **PD1781PT**

1XLED | 45W | 3600LM | 3000K  
**D1000**XA20mm  
 Bivolt

Pendente ● **PD1779DO**

1XLED | 27W | 2160LM | 3000K  
**D600**XA20mm  
 Bivolt

Pendente ● **PD1780DO**

1XLED | 36W | 2880LM | 3000K  
**D800**XA20mm  
 Bivolt

Pendente ● **PD1781DO**

1XLED | 45W | 3600LM | 3000K  
**D1000**XA20mm  
 Bivolt

Pendente ● **PD1779BR**

1XLED | 27W | 2160LM | 3000K  
**D600**XA20mm  
 Bivolt

Pendente ● **PD1780BR**

1XLED | 36W | 2880LM | 3000K  
**D800**XA20mm  
 Bivolt

Pendente ● **PD1781BR**

1XLED | 45W | 3600LM | 3000K  
**D1000**XA20mm  
 Bivolt

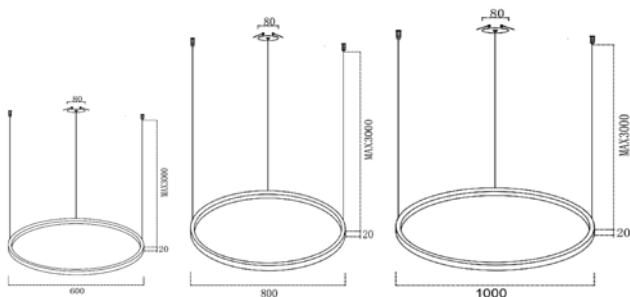

Cabo ajustável até 3000mm



PD1779DO, PD1780DO e PD1781DO

# Numa

Metal | Silicone | Dourado, Branco ou Preto - **Versão com Rebatedor**

LANÇAMENTO • 2023



Pendente • **PD1779PTAC003**

1XLED | 27W | 2160LM | 3000K  
**D600**XA20mm  
 Bivolt

Pendente • **PD1780PTAC004**

1XLED | 36W | 2880LM | 3000K  
**D800**XA20mm  
 Bivolt

Pendente • **PD1781PTAC005**

1XLED | 45W | 3600LM | 3000K  
**D1000**XA20mm  
 Bivolt

Pendente • **PD1779DOAC003**

1XLED | 27W | 2160LM | 3000K  
**D600**XA20mm  
 Bivolt

Pendente • **PD1780DOAC004**

1XLED | 36W | 2880LM | 3000K  
**D800**XA20mm  
 Bivolt

Pendente • **PD1781DOAC005**

1XLED | 45W | 3600LM | 3000K  
**D1000**XA20mm  
 Bivolt

Pendente • **PD1779BRAC003**

1XLED | 27W | 2160LM | 3000K  
**D600**XA20mm  
 Bivolt

Pendente • **PD1780BRAC004**

1XLED | 36W | 2880LM | 3000K  
**D800**XA20mm  
 Bivolt

Pendente • **PD1781BRAC005**

1XLED | 45W | 3600LM | 3000K  
**D1000**XA20mm  
 Bivolt

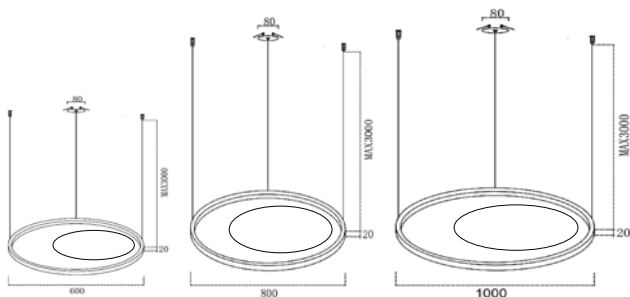

Cabo ajustável até 3000mm



PD1779BRA003 e PD1779DOAC003

# Gaia

Metal e Alumínio | Preto, Dourado ou Amadeirado



Detalhe da peça

SENSOR NA PARTE  
SUPERIOR DA PEÇA



Pendente • **PD1831PTMD**

1XLED | 48W | 2100LM | 3000K  
C1540XL50XA55mm  
Bivolt



Pendente • **PD1831PTDO**

1XLED | 48W | 2100LM | 3000K  
C1540XL50XA55mm  
Bivolt

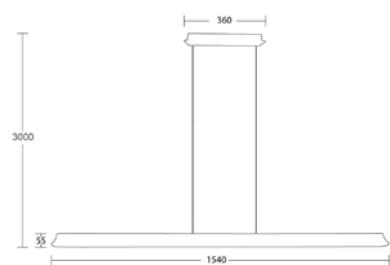

Cabo ajustável até 3000mm



Pendente • **PD1831PT**

1XLED | 48W | 2100LM | 3000K  
C1540XL50XA55mm  
Bivolt



PD1831PTMD



# Onde

Metal | Vidro | Preto ou Dourado

ACIONAMENTO INDIVIDUAL PARA OS 2  
CIRCUITOS NA PRÓPRIA PEÇA

LANÇAMENTO • 2023

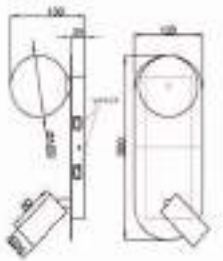

Arandela • **AR1798PT**

1XG9+LED | 8W | 210LM | 2700K  
C120XL300XA130mm  
Bivolt



Arandela • **AR1798DO**

1XG9+LED | 8W | 210LM | 2700K  
C120XL300XA130mm  
Bivolt



AR1798DO

# Passo

Metal | Silicone | Dourado, Preto e Branco

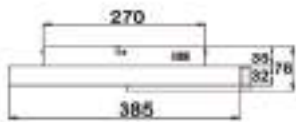

Plafon • **PL1796**

1XLED | 27W | 1620LM | 3000K  
D385XA76mm  
Bivolt

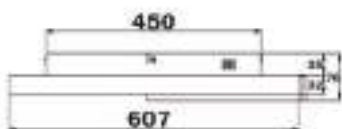

Plafon • **PL1797**

1XLED | 48W | 2880LM | 3000K  
D607XA76mm  
Bivolt



# Friso

Metal | Acrílico | Branco

LANÇAMENTO • 2023



Plafon • **PL1760**

1XLED | 30W | 1950LM | 3000K  
C350XL350XA45mm  
Bivolt



Plafon • **PL1759**

1XLED | 18W | 998LM | 3000K  
C200XL200XA40mm  
Bivolt

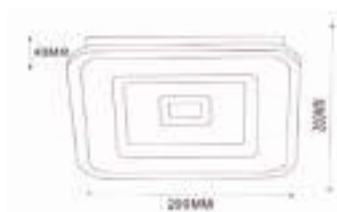



Plafon • **PL1761**

1XLED | 36W | 2250LM | 3000K  
C400XL400XA50mm  
Bivolt



PL1761

# Fita

Metal | Silicone | Preto ou Dourado

LANÇAMENTO • 2023

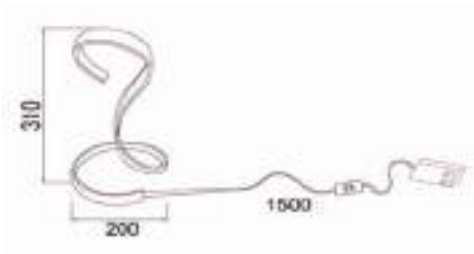

Cabo com 1500mm



Abajur • **AB1775PT**

1XLED | 15W | 1200LM | 3000K  
D200XA310mm  
Bivolt



Abajur • **AB1775DO**

1XLED | 15W | 1200LM | 3000K  
D200XA310mm  
Bivolt

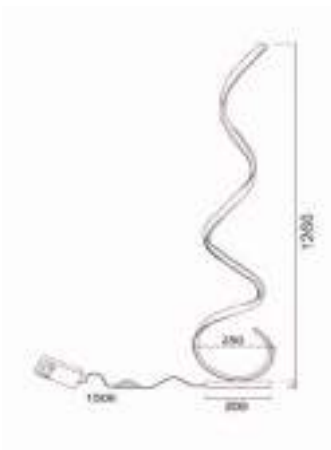

Cabo com 1500mm



Coluna • **CL1776PT**

1XLED | 24W | 1920LM | 3000K  
D250XA1260mm  
Bivolt



Coluna • **CL1776DO**

1XLED | 24W | 1920LM | 3000K  
D250XA1260mm  
Bivolt



CL177600

# Onda

Metal e Alumínio | Silicone | Preto, Branco ou Dourado

ACOMPANHA CABO USB  
NÃO ACOMPANHA CARREGADOR

LANÇAMENTO • 2023



Abajur • **AB1803BR**

1XLED | 5,6W | 200LM | 3000K  
D120XA380mm  
Bivolt



Abajur • **AB1803PT**

1XLED | 5,6W | 200LM | 3000K  
D120XA380mm  
Bivolt

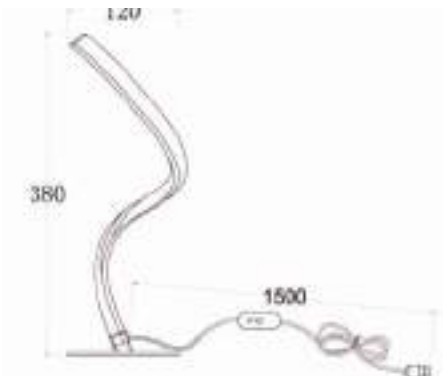

Cabo com 1500mm



AB1803DO



Abajur • **AB1803DO**

1XLED | 5,6W MAX | 200LM | 3000K  
D120XA380mm  
Bivolt



# Mimo

Metal | Pc | Preto, Branco ou Dourado

ACOMPANHA CABO USB  
NÃO ACOMPANHA CARREGADOR

LANÇAMENTO • 2023



Cabo com 1000mm



Abajur • **AB1788PT**

1XLED | 3,5W | 280LM | 3000K  
D110XA370mm  
Bateria Interna - USB-5V



Abajur • **AB1788DO**

1XLED | 3,5W | 280LM | 3000K  
D110XA370mm  
Bateria Interna - USB-5V



Abajur • **AB1788BR**

1XLED | 3,5W | 280LM | 3000K  
D110XA370mm  
Bateria Interna - USB-5V



AB1788BR

# Deja Vu

Acrílico | Transparente



Detalhe da peça

ACOMPANHA CABO USB E  
CONTROLE REMOTO  
NÃO ACOMPANHA CARREGADOR



Cabo com 1000mm



Abajur • **AB1785**

1XLED | 1W MAX | 90LM | RGBW  
D115XA255mm  
Bateria Interna - USB-3,7V-5V



AB1785

# Auê

Abs | Acrílico | Dourado ou Branco

LANÇAMENTO • 2023



Detalhe da peça

ACOMPANHA CABO USB E  
CONTROLE REMOTO  
NÃO ACOMPANHA CARREGADOR



Abajur • **AB1786DO**

1XLED | 1W | 90LM | RGBW  
D120XA232mm  
Bateria Interna - USB-3,7V-5V



Abajur • **AB1786BR**

1XLED | 1W | 90LM | RGBW  
D120XA232mm  
Bateria Interna - USB-3,7V-5V



Cabo com 1000mm



AB1786BR

# Dengo

Metal | Ps | Bronze, Preto ou Branco

LANÇAMENTO • 2023



**3000K** - Branco Quente



**4500K** - Branco Neutro



**6000K** - Branco Frio

ACOMPANHA CABO USB E  
CONTROLE REMOTO  
NÃO ACOMPANHA CARREGADOR

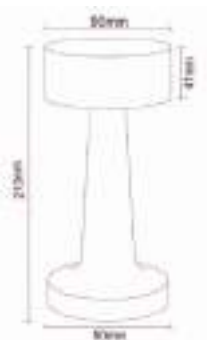

Cabo com 1000mm

Abajur • **AB1787PT**

1XLED | 3W | 270LM | 3000K/4500K/6000K  
D90XA213mm  
Bateria Interna - USB-3,7V-5V



Abajur • **AB1787DO**

1XLED | 3W | 270LM | 3000K/4500K/6000K  
D90XA213mm  
Bateria Interna - USB-3,7V-5V



Abajur • **AB1787BR**

1XLED | 3W | 270LM | 3000K/4500K/6000K  
D90XA213mm  
Bateria Interna - USB-3,7V-5V



AB1787PT

# Mia

Metal | Acrílico | Dourado ou Preto



Detalhe do difusor



Detalhe da base

ACOMPANHA CABO USB  
NÃO ACOMPANHA CARREGADOR

LANÇAMENTO • 2023



Abajur • **AB1821DO**

1XLED | 3W | 270LM | 3000K/4500K/6000K  
D130XA283mm  
Bateria Interna - USB-3,7V-5V



Abajur • **AB1821PT**

1XLED | 3W | 270LM | 3000K/4500K/6000K  
D130XA283mm  
Bateria Interna - USB-3,7V-5V



Cabo com 1000mm

# Zuzu

Metal | Silicone | Preto ou Branco

ACOMPANHA CABO USB  
NÃO ACOMPANHA CARREGADOR



Abajur • **AB1854PT**

1XLED | 8W | 720LM | 3000K  
D280XA360mm  
Bateria Interna - USB-3,7V-5V



Abajur • **AB1854BR**

1XLED | 8W | 720LM | 3000K  
D280XA360mm  
Bateria Interna - USB-3,7V-5V

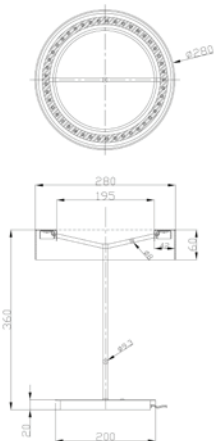

Cabo com 1500mm



# Tonton

Metal | Tecido | Preto ou Branco

CÚPULA INCLUSA

LANÇAMENTO • 2023

**FORA DE LINHA**



Abajur • **AB1856PT**

**FORA DE LINHA**

1XE27 | 40W MAX  
D295mm XA495mm  
Bivolt

**FORA DE LINHA**



Abajur • **AB1856BR**

**FORA DE LINHA**

1XE27 | 40W MAX  
D295mm XA495mm  
Bivolt

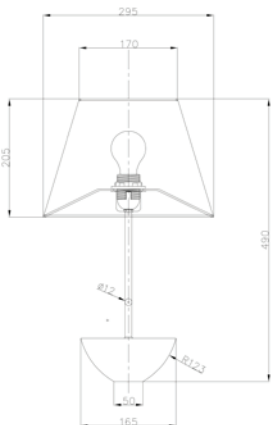

Cabo com 1600mm



AB1856BR

# Pilz

Metal e Madeira | Preto e Amadeirado

LANÇAMENTO • 2023



**FORA DE LINHA**

Abajur • **AB1857PT** FORA DE LINHA

1XG9 | 5W MAX  
D250XA520mm  
Bivolt

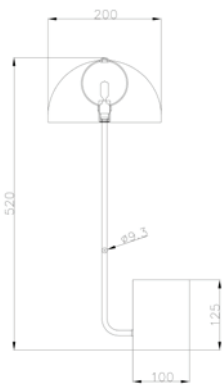

Cabo com 1600mm



AB1857PT

# Poti

Madeira | Tecido | Amadeirado e Branco

CÚPULA INCLUSA

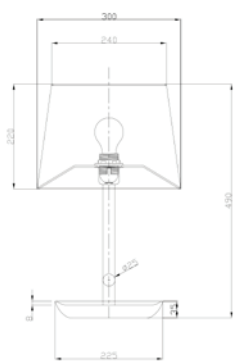

Cabo com 1600mm



Abajur • **AB1855MD**

1XE27 | 40W MAX  
D300XA485mm  
Bivolt



AB1855MD

# Kon

Madeira e Metal | Amadeirado e Dourado

CÚPULAS VENDIDAS SEPARADAMENTE

LANÇAMENTO • 2023



**CUP004BG**  
Cúpula

Base De Abajur • **BA018MD**

1XE27 | 40W MAX  
D150XA550mm  
Bivolt



**CUP001BR**  
Cúpula

Base De Abajur • **BA018PT**

1XE27 | 40W MAX  
D150XA550mm  
Bivolt

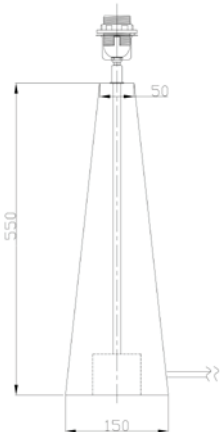

Cabo com 1600mm





BA018PT + CUP004BG

# Indira

Madeira e Metal | Amadeirado e Dourado ou Preto

CÚPULAS VENDIDAS SEPARADAMENTE

LANÇAMENTO • 2023



**CUP001PT**  
Cúpula

Base De Abajur • **BA019MD**

1XE27 | 40W MAX  
D120XA495mm  
Bivolt



**CUP001FD**  
Cúpula

Base De Abajur • **BA019PT**

1XE27 | 40W MAX  
D120XA495mm  
Bivolt



Cabo com 1600mm



BA019PT + CUP001FD



# Rustic

---

Metal e Fibra



**CUP006**  
Cúpula Cilíndrica  
D400XA300mm

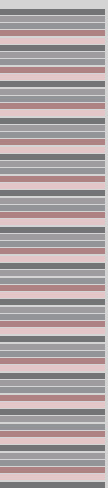

# LINHA STUDIOLUCE 2023



Studioluce  
ILUMINAÇÃO

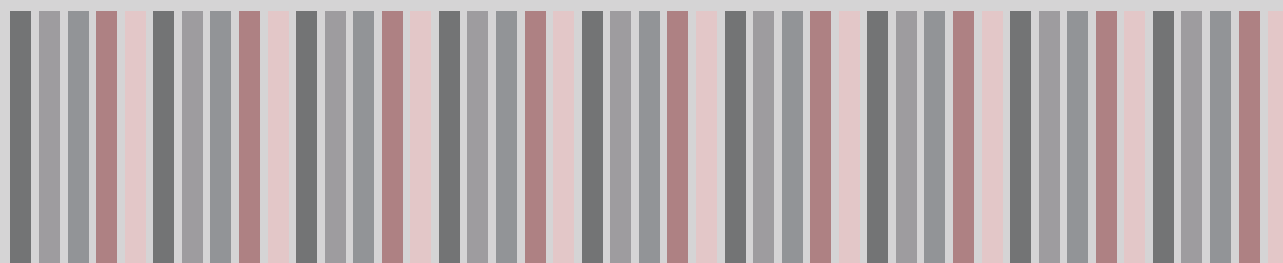

# Shell

Estrutura: Metal / Vidro  
Acabamento: Dourado



Detalhe do vidro



● **AR1696**

Arandela

3x G9 Halopin LED 5W  
Dimensões: C1200 x L150 x A150 mm  
Tensão: Bivolt (127V/220V)  
Potência máxima: 15W



● **PD1697**

Pendente

21x G9 Halopin LED 5W  
Dimensões: Ø750 x A330 mm  
Tensão: Bivolt (127V/220V)  
Potência máxima: 105W  
Cabo ajustável até 2000 mm



● **PD1698**

Pendente

10x G9 Halopin LED 5W  
Dimensões: C1200 x L150 x A150 mm  
Tensão: Bivolt (127V/220V)  
Potência máxima: 50W  
Cabo ajustável até 2000 mm



PD1698

# Toak

---

Estrutura: Metal/Vidro  
Acabamento: Dourado



Detalhe do vidro



● **PD1731**  
Pendente

10xG9 Halopin LED 5W  
Dimensões: C1000 x L380 x P230 mm  
Tensão: Bivolt (127V/220V)  
Potência máxima: 50W



PD1731

# Tarta

---

Estrutura: Metal / Vidro  
Acabamento: Dourado fosco



● **PD1728**  
Pendente

15xG9 Halopin LED 5W  
Dimensões: Ø800 x A460 mm  
Tensão: Bivolt (127V/220V)  
Potência máxima: 75W  
Cabo ajustável até 2000 mm



PD1728



# Land

Estrutura: Metal / Vidro

Acabamento: Preto (onix) ou dourado fosco



- PD1729
  - PD1729DO
- Pendente

LED 44W  
Lúmens: 2640lm  
Temperatura de cor: 3000K  
Dimensões: Ø700 x A150 mm  
Tensão: Bivolt (127V/220V)  
Potência máxima: 44W  
Cabo ajustável até 2000 mm



PD1729

# Hort

---

Estrutura: Metal / Vidro  
Acabamento: Dourado escovado



● **PD1732**  
Pendente

LED 38W  
Lúmens: 2280lm  
Temperatura: 3000K  
Dimensões: Ø600 x A245 mm  
Tensão: Bivolt (127V/220V)  
Potência máxima: 37W  
Cabo ajustável até 2000 mm



● **PD1733**  
Pendente

LED 60W  
Lúmens: 3600lm  
Temperatura: 3000K  
Dimensões: Ø1000 x A245 mm  
Tensão: Bivolt (127V/220V)  
Potência máxima: 60W  
Cabo ajustável até 2000 mm



PD1733

# Zenet

Estrutura: Metal/ Cristal

Difusor: Cristal

Acabamento: Dourado

## ● PD1650DO

Pendente

LED 23W

Lúmens: 1840lm

Temperatura: 3000K

Dimensões: C1200 x L36 x A76 mm

Tensão: Bivolt (127V/220V)

Potência máxima: 23W

Cabo ajustável até 1500 mm

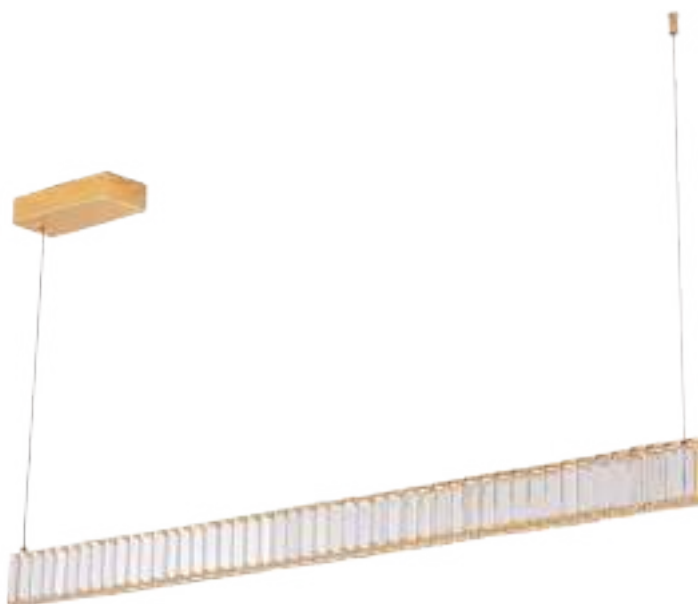

## ● PD1651DO

Pendente

LED 60W

Lúmens: 4800lm

Temperatura: 3000K

Dimensões: C1200 x L250 x A76 mm

Tensão: Bivolt (127V/220V)

Potência máxima: 60W

Cabo ajustável até 1500 mm





PD1651DO

# Crown

Estrutura: Metal

Difusor: Acrílico

Acabamento: Dourado



● **AR1709**

Arandela

LED 9W

Lúmens: 630lm

Temperatura: 3000K

Dimensões: C260 x A70 mm

Tensão: Bivolt (127V/220V)

Potência máxima: 9W



● **PL1710**

Plafon

LED 62W

Lúmens: 4340lm

Temperatura: 3000K

Dimensões: Ø630 x A70 mm

Tensão: Bivolt (127V/220V)

Potência máxima: 62W



● **PD1711** **FORA DE LINHA**  
Pendente

LED 85W  
Lúmens: 5950lm  
Temperatura: 3000K  
Dimensões: C1200 x L60 x A70 mm  
Tensão: Bivolt (127V/220V)  
Potência máxima: 85W  
Cabo 1500 mm



# Castillo

Estrutura: Metal

Cristais decorativos com ajuste de posição

Acabamento: Marrom



Sistema magnético para fixação/ajuste dos cristais

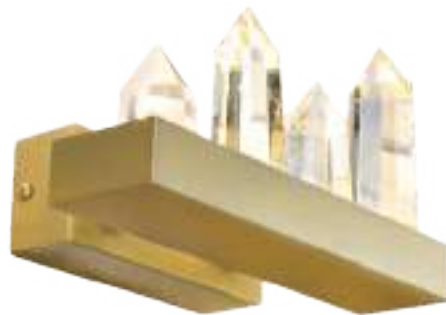

- AR1456
  - AR1456DO
  - AR1456PT
- Arandela

LED 8W / 680 lm / 3000K  
 Dimensões: C250 x A140 mm  
 Cristais: A80 + A100 + A120 + A140 mm  
 Tensão: Bivolt (127V/220V)

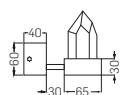

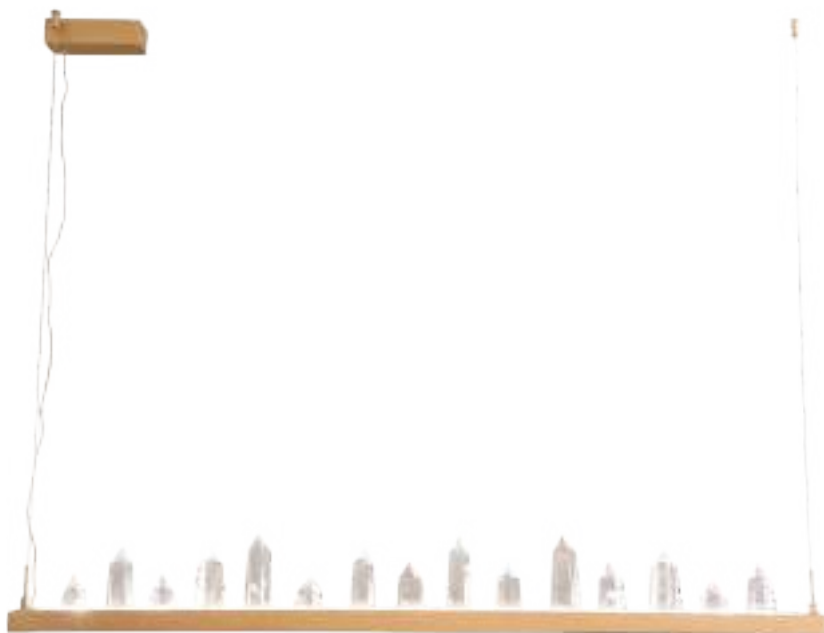
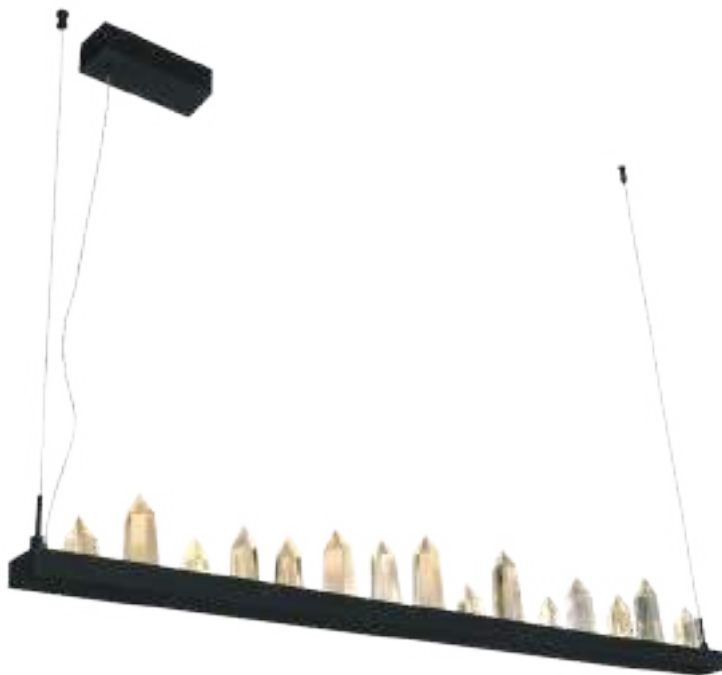

- PD1455
- PD1455DO
- PD1455PT

Pendente

LED 36W / 3060lm / 3000K

Dimensões: C1200 x A140 mm

Cristais: 4x80 + 4x100 + 4x120 + 3x140 mm

Tensão: Bivolt (127V/220V)

Cabo ajustável até 1,50 m

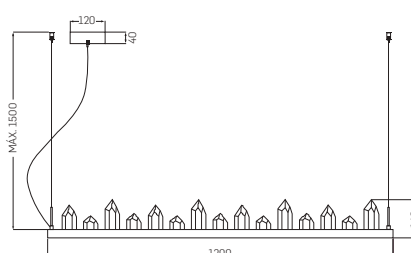

# Haken

Estrutura: Metal

Difusor: Cristal de rocha / Acrílico

Acabamento: Dourado ou Preto (onix)



Cristais de rocha



Difusor em acrílico



● PD1713D0

● PD17130X

Pendente

LED 30W

Lúmens: 1800lm

Temperatura: 3000K

Dimensões: C1500 x L80 x A345 mm

Tensão: Bivolt (127V/220V)

Potência máxima: 30W

Cabo ajustável até 2000 mm

PD1713D0



# Luxor

Estrutura: Metal / Cristal

Acabamento: Dourado



Detalhe do cristal



● **AR1676**

Arandela

LED 4W

Lúmens: 280lm

Temperatura: 3000K

Dimensões: C100 x L105 x A420 mm

Tensão: Bivolt (127V/220V)

Potência máxima: 4W



● **PD1677**

Pendente

LED 4W

Lúmens: 280lm

Temperatura: 3000K

Dimensões: Ø32 x A500 mm

Tensão: Bivolt (127V/220V)

Potência máxima: 4W

Cabo ajustável até 1500 mm



AR1676

# Lynus

Estrutura: Metal  
Difusor: Cristal transparente  
Acabamento: Bronze

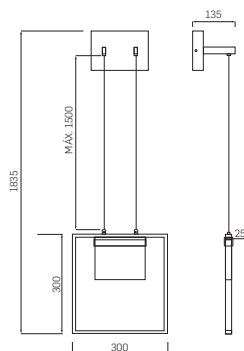
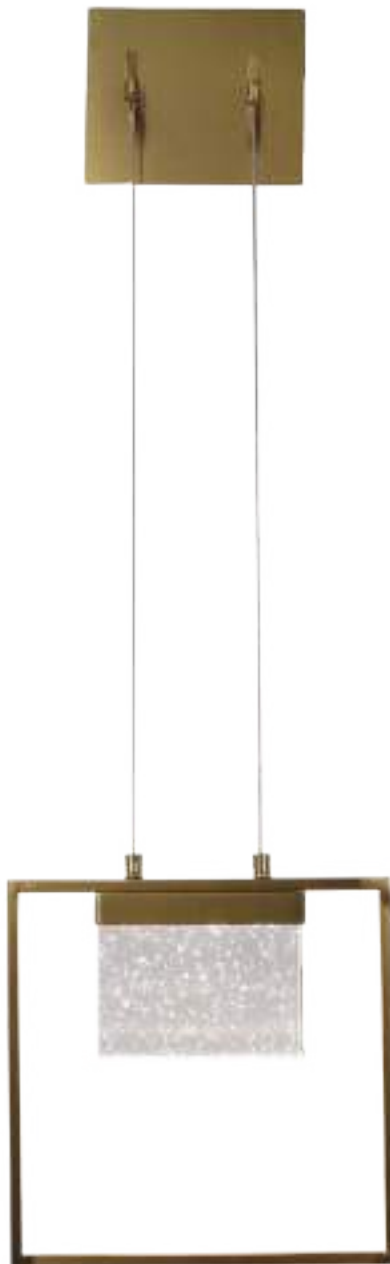

● **AR1468**  
Arandela

LED 4W / 320 lm / 3000K  
Dim.: C300 x L25 x A300 mm  
Tensão: Bivolt (127V / 220V)  
Cabo ajustável até 1500 mm

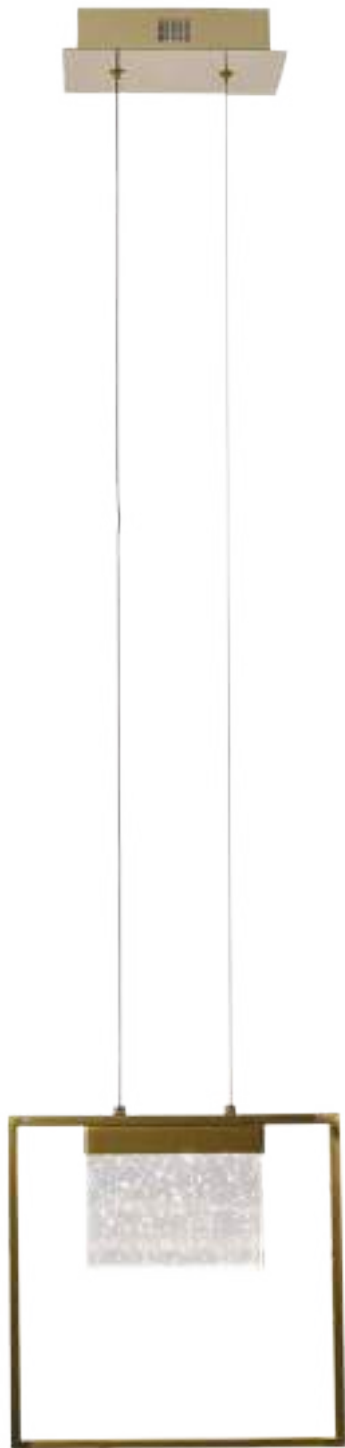

● **PD1472**  
Pendente

LED 4W / 320 lm / 3000K  
Dimensões: C300 x A300 mm  
Tensão: Bivolt (127V / 220V)  
Cabo ajustável até 1500 mm

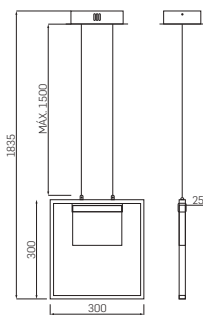



# Diamond

Estrutura: Metal

Difusor: Vidro branco misto transparente

Acabamento: Dourado



● **PD1715**

Pendente

5xG9 Halopin 5W

Dimensões: C1500 x L110 x A350 mm

Tensão: Bivolt (127V/220V)

Potência máxima: 5W

Cabo ajustável até 2000 mm



● **AR1515**  
Arandela

1xG9 Halopin / Máx. 5W  
Dimensões: C116 x L162 x A355,5 mm  
Tensão: Bivolt (127V/220V)

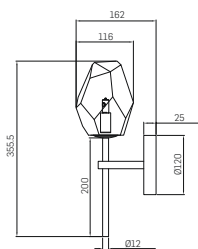

● **PD1516**  
Pendente

1xG9 Halopin / Máx. 5W  
Dimensões: C116 x A257,5 mm  
Tensão: Bivolt (127V/220V)  
Cabo ajustável até 2 m







AR1515



PD1516

# Laticius

Estrutura: Metal

Cúpula: Vidro Craquelê ou Vidro branco

Acabamento: Dourado

Disponíveis em duas opções de difusor



Detalhe do vidro



● **AR1409**  
Arandela



● **AR1409BR**  
Arandela

2xG9 Halopin LED 5W  
Dim.: C320 x L120 x A595 mm  
Tensão: Bivolt (127V / 220V)

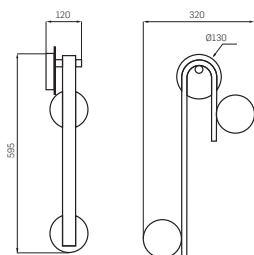



 ● **PD1407**  
Pendente

 ● **PD1407BR**  
Pendente

3xG9 Halopin LED 5W  
Dim.: C800 x L110 x A230 mm  
Tensão: Bivolt (127V / 220V)  
Cabo ajustável até 1500 mm

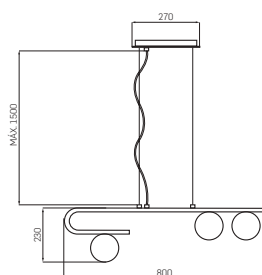

# Maya

Estrutura: Metal  
 Difusor: Cristal transparente  
 Acabamento: Bronze



● **AR1476**  
 Arandela

LED 3W / 240 lm / 3000K  
 Dimensões: C130 x L83 x A160 mm  
 Difusor: Ø130 mm  
 Tensão: Bivolt (127V / 220V)

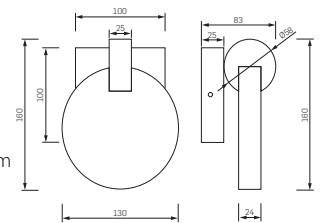

● **PD1473**  
 Pendente

LED 12W / 960 lm / 3000K  
 Dim.: C120 x L350 x A250 mm  
 Difusor: Ø110 / Ø130 mm  
 Tensão: Bivolt (127V / 220V)  
 Cabo ajustável até 1500 mm

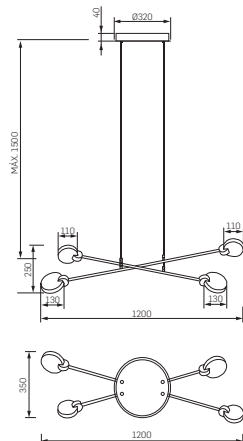



**PD1475**  
Compatível com  
canopla para gesso  
(vendida separadamente)



● **PD1475**  
Pendente

LED 3W / 240 lm / 3000K  
Dimensões: Ø130 x A170 mm  
Difusor: Ø130 mm  
Tensão: Bivolt (127V / 220V)  
Cabo ajustável até 1500 mm



PD1475



# Blur

Estrutura: Metal  
 Difusor: Cristal de rocha  
 Acabamento: Preto



● **PD1494**  
 Pendente

LED 3W / 240lm / 3000K  
 Dim.: Ø130 x A170 mm  
 Tensão: Bivolt (127V/220V)  
 Cabo ajustável até 1500 mm



● **PD1495**  
 Pendente

LED 3W / 240lm / 3000K  
 Dim.: C128 x A160 mm  
 Tensão: Bivolt (127V/220V)  
 Cabo ajustável até 1500 mm

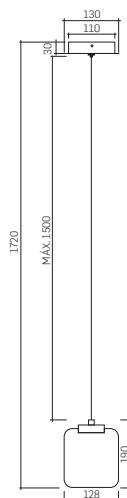

# Horus

Estrutura: Metal / Cristal  
Acabamento: Dourado

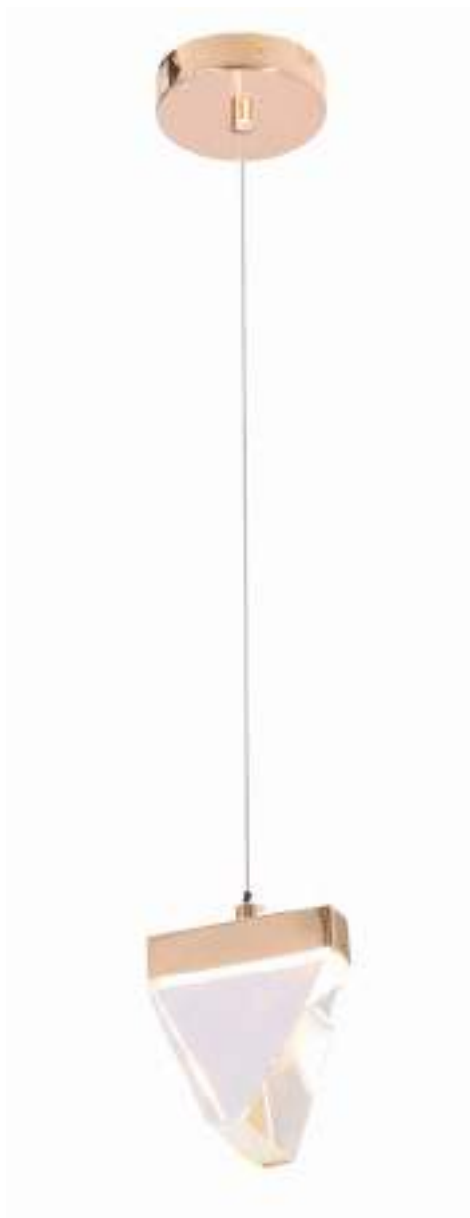

● **PD1661**  
Pendente

LED 3W  
Lúmens: 120lm  
Temperatura: 3000K  
Dimensões: Ø105 x C1500 x A118 mm  
Tensão: Bivolt (127V/220V)  
Potência máxima: 3W  
Cabo ajustável até 1500 mm



AR1660



● **AR1660**  
Arandela

LED 3W  
Lúmens: 120lm  
Temperatura: 3000K  
Dimensões: Ø105 x A118 mm  
Tensão: Bivolt (127V/220V)  
Potência máxima: 3W

# Gali

Estrutura: Metal / Alumínio/ Acrílico  
Acabamento: Dourado ou Preto (Onix)



● **PD1723DO**  
Pendente

LED 5W  
Lúmens: 300lm  
Temperatura: 3000K  
Dimensões: Ø30 x L30 x A345 mm  
Tensão: Bivolt (127V/220V)  
Potência máxima: 5W  
Cabo 2000 mm

● **PD1724OX**  
Pendente

LED 13W  
Lúmens: 780lm  
Temperatura: 3000K  
Dimensões: Ø150 x L150 x A345 mm  
Tensão: Bivolt (127V/220V)  
Potência máxima: 13W  
Cabo 2000 mm



**PD1723OX**

**PD1723DO**



**PD1724OX**

**PD1724DO**



PD17240X



# Hazel

---

Estrutura: Metal/cristal  
Acabamento: Dourado



● **PD1699**  
Pendente

LED 4W  
Lúmens: 294lm  
Temperatura: 3000K  
Dimensões: Ø90 x A175 mm  
Tensão: Bivolt (127V/220V)  
Potência máxima: 4W  
Cabo 1500 mm



PD1699

# Jadore

Estrutura: Metal / Cristal  
Difusor: Cristal de rocha  
Acabamento: Preto ou dourado



Detalhe do difusor



● **PD1688OX**  
Pendente

LED 4W  
Lúmens: 280lm  
Temperatura: 3000K  
Dimensões: Ø100 x A800 mm  
Tensão: Bivolt (127V/220V)  
Potência máxima: 4W  
Cabo ajustável até 1500 mm



**PD1688DO**



**PD1688OX**



PD16880X



# Sion

Estrutura: Metal/cúpula de vidro

Vidro: Transparente

Acabamento: Preto ou Dourado



Detalhe do vidro



● **ARH1585PT**

Arandela

1xG9 Halopin 5W  
Dimensões: C120 x L45 x A120 mm  
Tensão: Bivolt (127V/220V)  
Potência máxima: 5W



**ARH1585DO**



**ARH1585PT**



● **PDH1586DO**

Pendente

1xG9 Halopin 5W  
Dimensões: Ø45 x A400 mm  
Tensão: Bivolt (127V/220V)  
Potência máxima: 5W  
Cabo ajustável até 1500 mm



**PDH1586DO**



**PDH1586PT**



PDH1586PT

# Antik

Estrutura: Metal/ Vidro

Difusor: Vidro fosco

Acabamento: Dourado



● **AR1717DO**

Arandela

1x G9 Halopin 5W

Dimensões: L100 x P230 x A280 mm

Tensão: Bivolt (127V/220V)

Potência máxima: 5W



● **AR1718DO**

Arandela

2x G9 Halopin 5W

Dimensões: L230 x P260 x A280 mm

Tensão: Bivolt (127V/220V)

Potência máxima: 10W



PD1718DO



● **PD1716DO**  
Pendente

8x G9 Halopin 5W  
Dimensões: 790 x L340 x A340 mm  
Tensão: Bivolt (127V/220V)  
Potência máxima: 40W  
Cabo ajustável até 2000 mm

# Sophi

Estrutura: Metal e vidro  
 Bobeches: Vidro  
 Acabamento: Bronze e preto

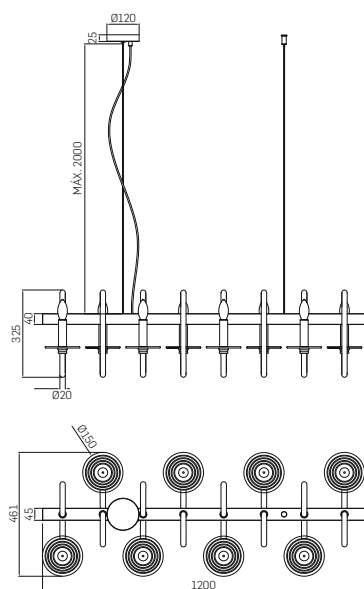
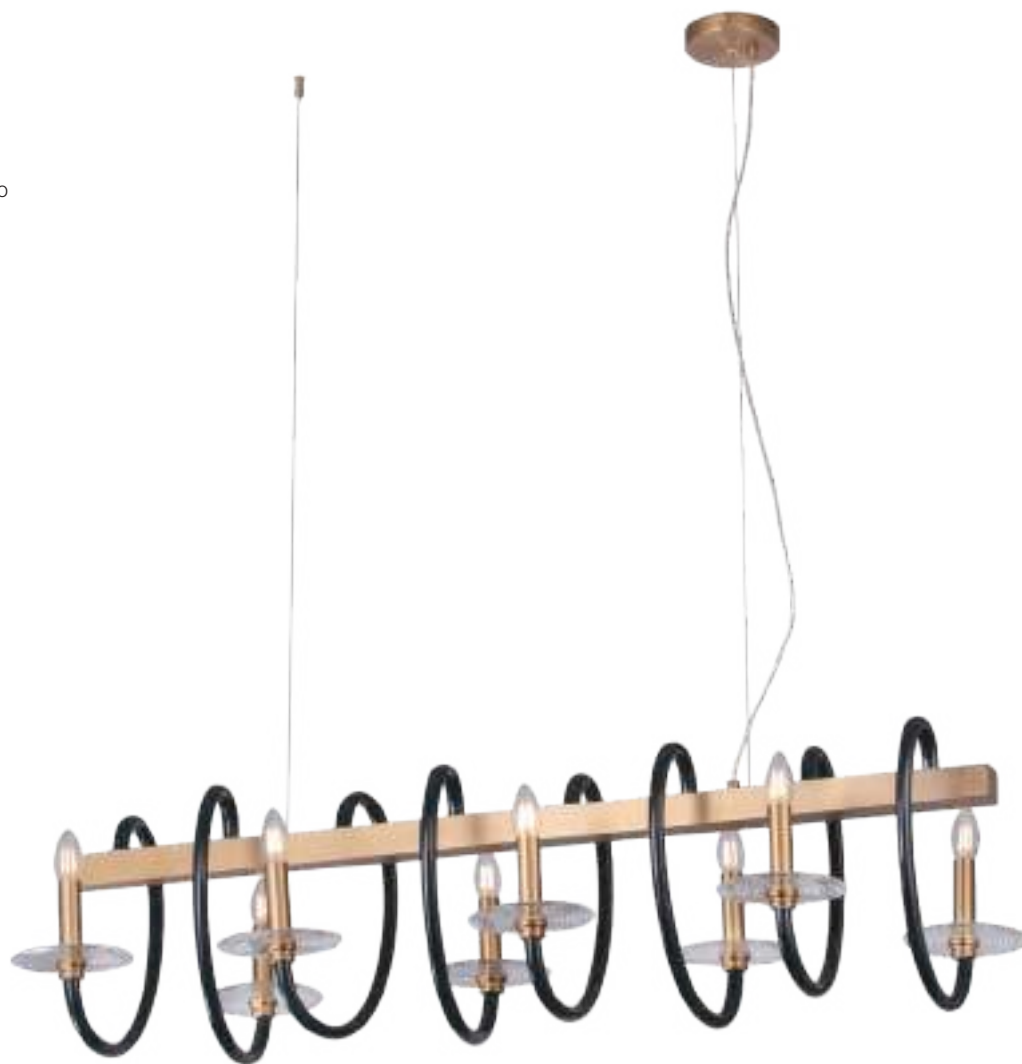

● **PD1512**

Pendente

8xE14 / 40W

Dimensões: C1200 x L461 x A325 mm

Tensão: Bivolt (127V/220V)

Cabo ajustável até 2000 mm



AR1511



● **AR1511**  
Arandela

1xE14 / 40W  
Dimensões: C357 x L120 x A321 mm  
Tensão: Bivolt (127V/220V)

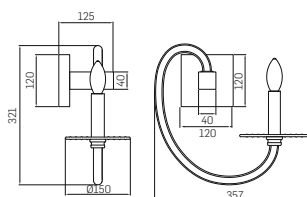

# Suez

Estrutura: Alumínio

Difusor: Material tipo alabastro

Acabamento: Dourado ou preto



● **ARSH1568DO**

● **ARSH1568PT**

Arandela/Plafon

LED 8,4W / 167,4lm / 3000K  
 Potência Máx.: 8,4W  
 Dimensões: C145 x L80 x A300 mm  
 Tensão: Bivolt (127V/220V)

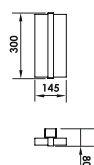

● **ARSH1569DO**

● **ARSH1569PT**

Arandela/Plafon

LED 21W / 418,5lm / 3000K  
 Potência máx.: 21W  
 Dimensões: C145 x L80 x A550 mm  
 Tensão: Bivolt (127V/220V)

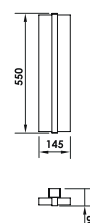



ARSH1568PT

- ARSH1570DO
- ARSH1570PT

Arandela/Plafon

LED 33,6W / 669,6lm / 3000K  
Potência máx.: 33,6W  
Dimensões: C145 x L80 x A800 mm  
Tensão: Bivolt (127V/220V)

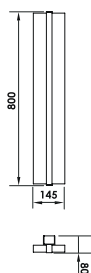



# Suez

Estrutura: Alumínio  
 Difusor: Material tipo alabastro  
 Acabamento: Dourado ou preto



LMSH1574DO



- LMSH1574DO
- LMSH1574PT

Luminária de mesa

LED 21W / 418,5lm / 3000K  
 Potência máx.: 21W  
 Dimensões: C160 x L110 x A640 mm  
 Tensão: Bivolt (127V/220V)

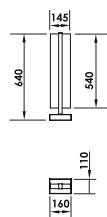

- CLSH1575DO
- CLSH1575PT

Coluna

LED 21W / 418,5lm / 3000K  
 Potência máx.: 21W  
 Dimensões: C160 x L160 x A1390 mm  
 Tensão: Bivolt (127V/220V)

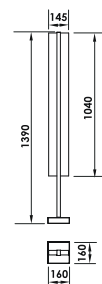



CLSH1575PT

# Suez

Estrutura: Alumínio

Difusor: Material tipo alabastro

Acabamento: Dourado ou preto



- PDSH1566LED1DO (127V)
- PDSH1566LED2DO (220V)
- PDSH1566LED1PT (127V)
- PDSH1566LED2PT (220V)

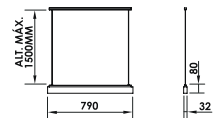

Pendente

LED 13,2W / 270lm / 3000K  
 Potência máx.: 13,2W  
 Dimensões: C790 x L80 x A32 mm  
 Tensão: 127V ou 220V

- PDSH1567LED1DO (127V)
- PDSH1567LED2DO (220V)
- PDSH1567LED1PT (127V)
- PDSH1567LED2PT (220V)

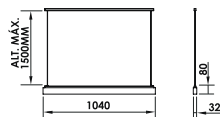

Pendente

LED 17,6W / 360lm / 3000K  
 Potência máx.: 17,6W  
 Dimensões: C1040 x L80 x A32 mm  
 Tensão: 127V ou 220V



PDSH1567LED1PT

# Suez

Estrutura: Alumínio

Difusor: Material tipo alabastro

Acabamento: Dourado ou preto



- PLSH1561LED1DO (127V)
- PLSH1561LED2DO (220V)
- PLSH1561LED1PT (127V)
- PLSH1561LED2PT (220V)

Arandela/Plafon

LED 4,4W / 90lm / 3000K

Potência máx.: 4,4W

Dimensões: C290 x L80 x A32 mm

Tensão: 127V ou 220V

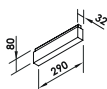

- PLSH1562LED1DO (127V)
- PLSH1562LED2DO (220V)
- PLSH1562LED1PT (127V)
- PLSH1562LED2PT (220V)

Arandela/Plafon

LED 8,8W / 180lm / 3000K

Potência máx.: 8,8W

Dimensões: C540 x L80 x A32 mm

Tensão: 127V ou 220V

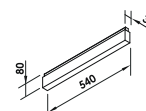



PLSH1563LED1PT



- PLSH1563LED1DO (127V)
- PLSH1563LED2DO (220V)
- PLSH1563LED1PT (127V)
- PLSH1563LED2PT (220V)

Arandela/Plafon

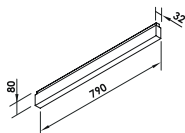

LED 13,2W / 270lm / 3000K  
 Potência máx.: 13,2W  
 Dimensões: C790 x L80 x A32 mm  
 Tensão: 127V ou 220V



- PLSH1564LED1DO (127V)
- PLSH1564LED2DO (220V)
- PLSH1564LED1PT (127V)
- PLSH1564LED2PT (220V)

Arandela/Plafon

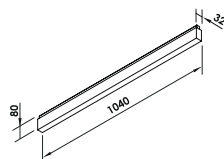

LED 17,6W / 360lm / 3000K  
 Potência máx.: 17,6W  
 Dimensões: C1040 x L80 x A32 mm  
 Tensão: 127V ou 220V

# Suez

Estrutura: Alumínio

Difusor: Material tipo alabastro

Acabamento: Dourado ou preto



● PLSH1589DO

● PLSH1589PT

Arandela/Plafon

LED 26,6W / 630lm / 3000K

Potência máx.: 26,6W

Dimensões: C540 x L540 x A40 mm

Tensão: 127V / 220V

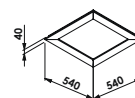

● PLSH1588DO

● PLSH1588PT

Arandela/Plafon

LED 19W / 450lm / 3000K

Potência máx.: 19W

Dimensões: C400 x L400 x A40 mm

Tensão: 127V / 220V

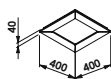



PLSH1589D0



# Suez

Estrutura: Alumínio

Difusor: Material tipo alabastro

Acabamento: Dourado ou preto



● PDSH1572DO  
● PDSH1572PT

Pendente

LED 8,4W / 167,4lm / 3000K  
Potência máx.: 8,4W  
Dimensões: C145 x L40 x A300 mm  
Tensão: Bivolt (127V/220V)

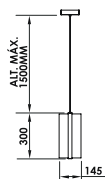

● PDSH1573DO  
● PDSH1573PT

Pendente

LED 21W / 418,5lm / 3000K  
Potência máx.: 21W  
Dimensões: C145 x L40 x A550 mm  
Tensão: Bivolt (127V/220V)

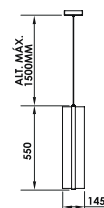



PDSH1573PT

# Suez

Estrutura: Alumínio

Difusor: Material tipo alabastro

Acabamento: Dourado ou preto



● PDSH1575DO

● PDSH1575PT

Pendente

LED 42W / 837lm / 3000K

Potência máx.: 42W

Dimensões: C1050 x L145 x A40 mm

Tensão: Bivolt (127V/220V)

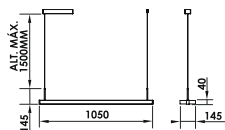



PDSH1575D0

# Versa

Estrutura: Aço inox

Difusor: Sílica gel branco

Acabamento: Dourado ou Preto (onix)



● PD1708DO

● PD1708OX

Pendente

LED 91W

Lúmens: 6370lm

Temperatura: 2900K

Dimensões: C1550 x L330 x A360 mm

Tensão: Bivolt (127V/220V)

Potência máxima: 91W

Cabo ajustável até 1500 mm



PD17080X

# Atenas

Estrutura: Metal/ Acrílico

Difusor: Acrílico

Acabamento: Dourado



● **PD1764**  
Pendente

LED 28W  
Lúmens: 1468lm  
Temperatura: 3000K  
Dimensões: C1000 x L295 x A150 mm  
Tensão: Bivolt (127V/220V)  
Potência máxima: 28W  
Cabo ajustável até 3000 mm



● **PD1765**  
Pendente

LED 37W  
Lúmens: 1762lm  
Temperatura: 3000K  
Dimensões: C1500 x L435 x A150 mm  
Tensão: Bivolt (127V/220V)  
Potência máxima: 37W  
Cabo ajustável até 3000 mm



PD1765



# Netz

---

Estrutura: Metal/ Vidro / Couro sintético

Difusor: Vidro transparente/fosco

Acabamento: Preto



Detalhe do difusor



● **PD1737**

Pendente

LED 21W

Lúmens: 1470lm

Potência: 3000K

Dimensões: C2500 x A900 mm

Tensão: Bivolt (127V/220V)

Potência máxima: 21W

**FORA DE LINHA**



PD1737

# Lune

Estrutura: Metal

Difusor: Vidro canelado transparente e parte interna em vidro opalino

Acabamento: Dourado



● **PD1519**  
Pendente

12V / 2x11W / 1320lm / 3000K  
Dimensões: Ø200 x C350 x A2098 mm  
Tensão: Bivolt (127V/220V)  
Cabo ajustável até 2100 mm

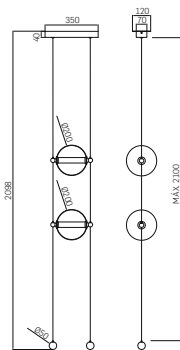

● **PD1518**  
Pendente

12V / 11W / 660 lm / 3000K  
Dimensões: Ø200 x C350 x A2098 mm  
Tensão: Bivolt (127V/220V)  
Cabo ajustável até 2100 mm

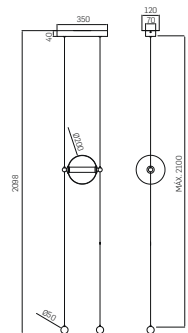

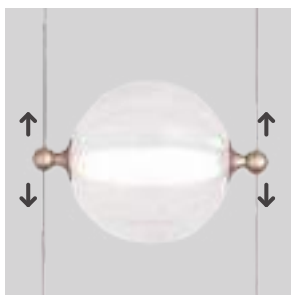

Difusor com posição ajustável através de trava-cabo de fácil manuseio



● **PD1520**  
Pendente

12V / 4x10W / 2400lm / 3000K  
Dimensões: Ø200 x C1100 x A2098 mm  
Tensão: Bivolt (127V/220V)  
Cabo ajustável até 2100 mm

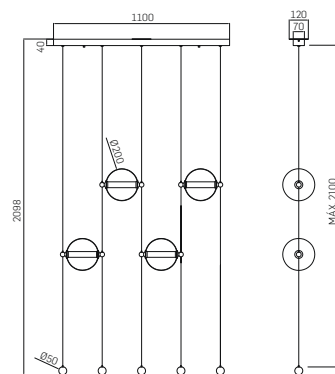

# Lance

---

Estrutura: Metal/ Silicone

Difusor: Silica gel

Acabamento: Preto



Difusor  
em material  
flexível  
- Sílica gel -

● **PD1739**

Pendente

LED 40W

Lúmens: 2800lm

Potência: 3000K

Dimensões: C2000 x A600 mm

Tensão: Bivolt (127V/220V)

Potência máxima: 40W



PD1739

# Lorum

Estrutura: Metal/ Vidro / Couro sintético

Difusor: Acrílico

Acabamento: Preto



● **PD1738**

Pendente

LED 13W + 15w

Lúmens: 1960lm

Potência: 3000K

Dimensões: C470+450 x A1300 + 1500 mm

Tensão: Bivolt (127V/220V)

Potência máxima: 28W



PD1738



# Zavo

Estrutura: Metal

Difusor **CL1493**: Acrílico (rígido)

Acabamento: Preto ou dourado

Difusor  
em material  
rígido  
- Acrílico -

## ● CL1493

Coluna

LED 15W / 720lm / 3000K  
Dim.: Ø305 x A1500 mm  
Tensão: Bivolt (127V/220V)  
Cabo com 3200 mm

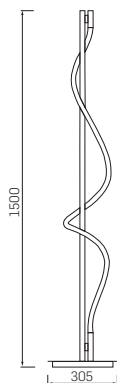



CL1493

# Dock

Estrutura: Metal/Sílica gel  
Difusor: Tubo em sílica gel opalino  
Acabamento: Dourado

Difusor  
em material  
flexível  
- Sílica gel -



## PD1746

Pendente

LED 10W  
Lúmens: 700lm  
Temperatura: 3000K  
Dimensões: C840 x L22 x A620 mm  
Tensão: Bivolt (127V/220V)  
Potência máxima: 10W



## ● PD1747

Pendente

LED 15W  
Lúmens: 1050lm  
Temperatura: 3000K  
Dimensões: C1100 x L22 x A800 mm  
Tensão: Bivolt (127V/220V)  
Potência máxima: 15W



PD1746 / PD1747

# Wala

Estrutura: Metal/ Acrílico

Acabamento: Dourado ou Preto (onix)



● **PD1686DO**

Pendente

LED 12W

Lúmens: 960lm

Temperatura: 3000K

Dimensões: C140 x L22 x A650 mm

Tensão: Bivolt (127V/220V)

Potência máxima: 12W

Cabo ajustável até 1500 mm



**PD1686DO**



**PD1686OX**



AB1685DO



● **AB1685DO**

Abajur

LED 12W

Lúmens: 960lm

Temperatura: 3000K

Dimensões: Ø150 x A525 mm

Tensão: Bivolt (127V/220V)

Potência máxima: 12W



**AB1685DO**



**AB1685OX**

# Wala

---

Estrutura: Metal/ Acrílico

Acabamento: Dourado ou Preto (onix)

● **CL1687DO**

Coluna

LED 18W

Lúmens: 1440lm

Temperatura: 3000K

Dimensões: Ø200 x A1200 mm

Tensão: Bivolt (127V/220V)

Potência máxima: 18W



**CL1687DO**



**CL1687OX**





CL16870X



# Anello

Estrutura: Metal/alumínio/acrílico

Acrílico: Transparente

Acabamento: Dourado

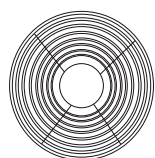
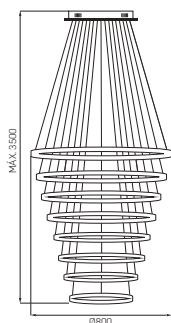

● **PD1442**  
Pendente

LED 180W / 9000lm / 3000K  
Dimensões:  
Ø800 + Ø730 + Ø670 + Ø605 +  
Ø540 + Ø480 + Ø415 + Ø350 x  
A3500 mm  
Tensão: Bivolt (127V/220V)  
Cabo ajustável até 3500 mm



PD1442

# Anello

Estrutura: Metal/alumínio/acrílico

Acrílico: Transparente

Acabamento: Dourado

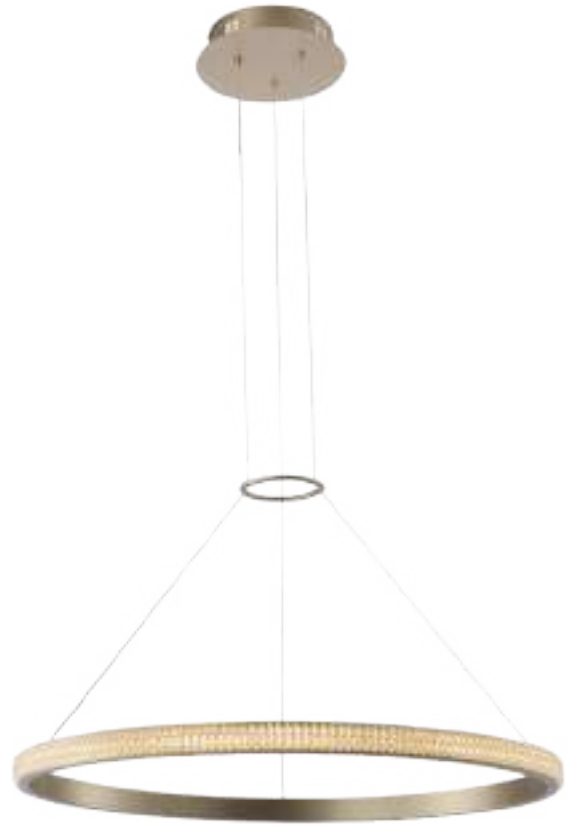

● **PD1440**  
Pendente

LED 28W / 1400lm / 3000K  
Dimensões: Ø605 x A1200 mm  
Tensão: Bivolt (127V/220V)  
Cabo ajustável até 1500 mm

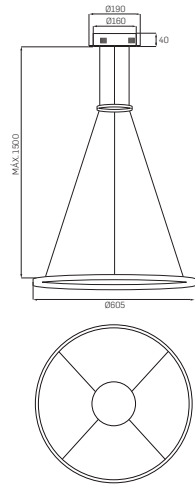

● **PD1441**  
Pendente

LED 40W / 2000lm / 3000K  
Dim.: Ø670 + Ø480 x A1500 mm  
Tensão: Bivolt (127V/220V)  
Cabo ajustável até 1500 mm

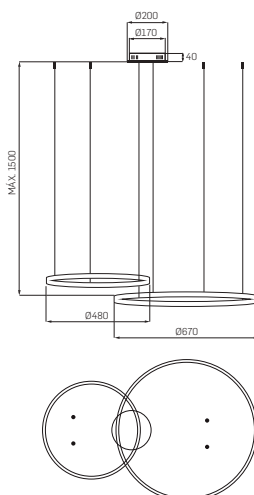
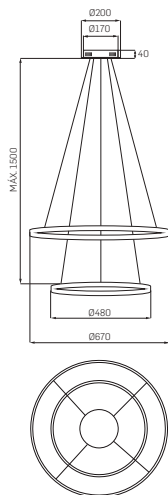

OPÇÃO DE INSTALAÇÃO SEM CHUMBADOR



**CAN008**  
Canopla

Opção de instalação com apenas canopla, sem chumbadores

Vendido separadamente



● **AR1487**  
Arandela

LED 7W / 350lm / 3000K  
Dimensões: C350 x A30 mm  
Tensão: Bivolt (127V/220V)

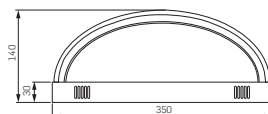

# Anello Oval

Estrutura: Metal/alumínio/acrílico

Acrílico: Transparente

Acabamento: Dourado



● **PD1443**  
Pendente

LED 28W / 1400lm / 3000K  
Dimensões: Ø800 x A30 mm  
Tensão: Bivolt (127V/220V)  
Cabo ajustável até 1500 mm

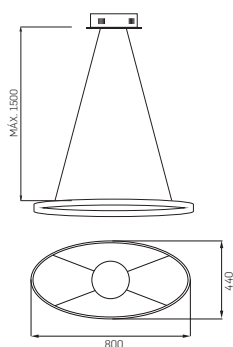



# Balka

Estrutura: Metal / Vidro

Difusor: Vidro fosco

Acabamento: Branco ou Dourado



- PD1712BR
  - PD1712DO
- Pendente

40x G9 Halopin LED 5W  
Dimensões: Ø1000 x A480 mm  
Tensão: Bivolt (127V/220V)  
Potência máxima: 200W  
Cabo ajustável até 1500 mm



PD1712D0



# Cissy

Estrutura: Metal

Difusor: Acrílico com efeito degradê  
(fosco/cristal)

Acabamento: Dourado ou preto



● **PD1509**  
Pendente

8L / 30W / 1800 lm / 3000K  
Dimensões: Ø750 x A500 mm  
Tensão: Bivolt (127V/220V)  
Cabo ajustável até 2000 mm

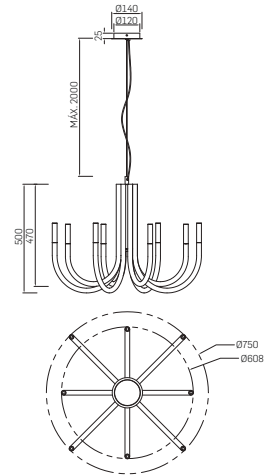

● **PD1510**  
Pendente

15L / 59W / 3540lm / 3000K  
Dimensões: Ø850 x A595 mm  
Tensão: Bivolt (127V/220V)  
Cabo ajustável até 2000 mm

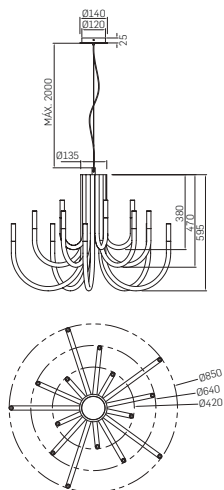

PD1510



PD1642DO



● PD1642DO

● PD1642PT

Pendente

5L / 15W / 900lm / 3000K

Dimensões: L1200 x A400 x P490 mm

Tensão: Bivolt (127V/220V)

Cabo ajustável até 2000 mm

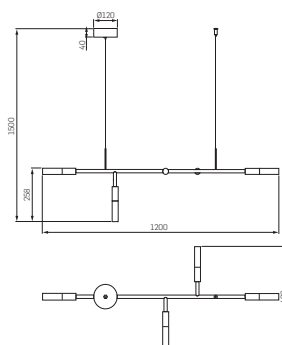

# Cissy

Estrutura: Metal

Difusor: Acrílico com efeito degradê  
(fosco/cristal)

Acabamento: Dourado ou preto



● PD1508DO

● PD1508PT

Pendente

3W / 180lm / 3000K

Dimensões: Ø30 x A360 mm

Tensão: Bivolt (127V/220V)

Cabo ajustável até 2000 mm



PD1508DO



PD1508DO / PD1508PT  
Compatíveis com  
canopla para gesso  
(vendida separadamente)



● **AR1722**

Arandela

LED 3W  
Lúmens: 180lm  
Temperatura: 3000K  
Dimensões: L120x P190 x A320 mm  
Tensão: Bivolt (127V/220V)  
Potência máxima: 3W



● **AR1507**

Arandela

10W / 600 lm / 3000K  
Dimensões: C245 x L170 x A320 mm  
Tensão: Bivolt (127V/220V)

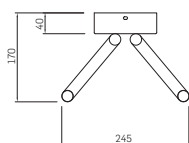
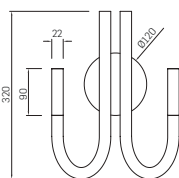

# Cissy

Estrutura: Metal

Difusor: Acrílico com efeito degradê  
(fosco/cristal)

Acabamento: Dourado ou preto

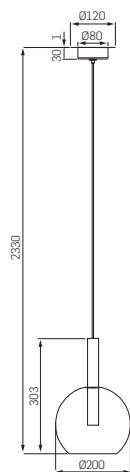

● PD1484DO

● PD1484PT

Pendente

3W / 180lm / 3000K

Dimensões: Ø200 x A300 mm

Tensão: Bivolt (127V/220V)

Cabo ajustável até 2000 mm





PD1484DO

# Blade

Estrutura: Metal

Difusor: Acrílico com efeito degradê  
(fosco/cristal)

Acabamento: Dourado ou preto



● PD1501ADO

● PD1501A

Pendente

10L / 39W / 2340lm / 3000K

Dim.: Ø700 x A370 mm

Tensão: Bivolt (127V/220V)

Cabo ajustável até 2000 mm

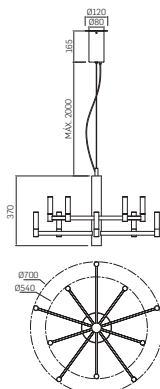



PD1502ADO



● PD1502ADO

● PD1502A

Pendente

16L / 54W / 3240lm / 3000K  
 Dimensões: Ø840 x A485 mm  
 Tensão: Bivolt (127V/220V)  
 Cabo ajustável até 2000 mm

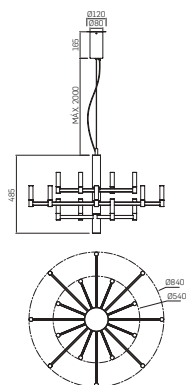



# Blade

Estrutura: Metal

Difusor: Acrílico com efeito degradê  
(fosco/cristal)

Acabamento: Dourado ou preto



● **AR1500ADO**

● **AR1500A**

Arandela

3W / 180lm / 3000K

Dimensões: C50 x L90 x A155 mm

Tensão: Bivolt (127V/220V)

Potência máxima: 3W

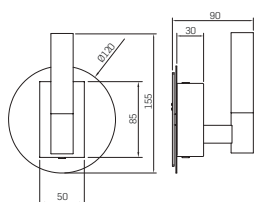



**● PD1503ADO**  
**● PD1503A**  
Pendente

10L / 39W / 2340lm / 3000K  
Dimensões: C1100 x A140 mm  
Tensão: Bivolt (127V/220V)  
Cabo ajustável até 2000 mm

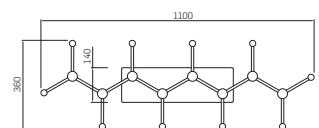
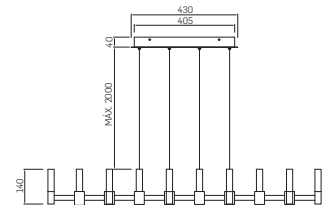

# Zione

Estrutura: Metal

Difusor: Acrílico

Acabamento: Dourado ou preto



● **AR1646DO**

● **AR1646PT**

Arandela

LED 2x3W

Lúmens: 480lm

Temperatura: 3000K

Dimensões: L30 x P48 x A250 mm

Tensão: Bivolt (127V/220V)

Potência máxima: 6W



● **AR1647DO**

● **AR1647PT**

Arandela

LED 3W

Lúmens: 240lm

Temperatura: 3000K

Dimensões: L30 x P48 x A145 mm

Tensão: Bivolt (127V/220V)

Potência máxima: 3W





AR1646PT

# Zione

Estrutura: Metal  
 Difusor: Acrílico  
 Acabamento: Dourado ou preto



Pendente articulável



**PD1488DO / PD1488PT**  
 Compatíveis com  
 canopla para gesso  
 (vendida separadamente)

- **PD1488DO**
  - **PD1488PT**
- Pendente

LED 1x3W / 240 lm / 3000K  
 Dim.: Ø35 x A380 mm  
 Tensão: Bivolt (127V/220V)  
 Cabo ajustável até 1500 mm

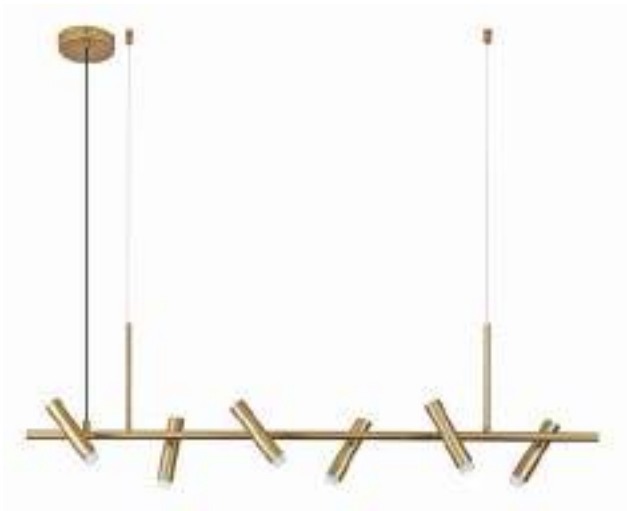
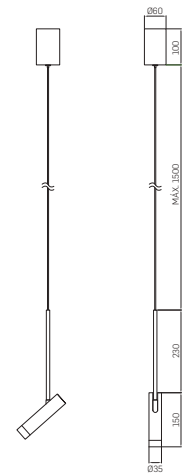

- **PD1491DO**
  - **PD1491**
- Pendente

LED 6x3W / 1440 lm / 3000K  
 Dim.: C1100 x A145 mm  
 Tensão: Bivolt (127V/220V)  
 Cabo ajustável até 1500 mm

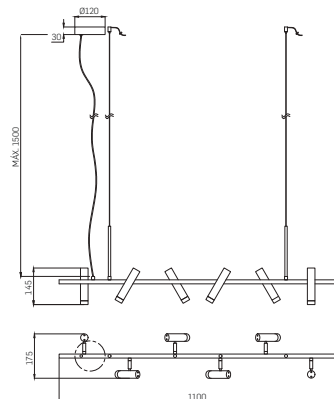



● PD1498DO

● PD1498

Pendente

21W (7x3W) / 1680 lm / 3000K

Dim.: Ø700 x A240 mm

Tensão: Bivolt (127V/220V)

Cabo ajustável até 1500 mm

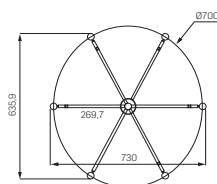
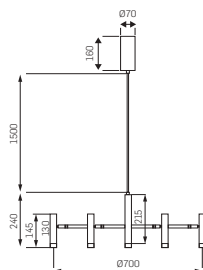

# Zione

Estrutura: Metal

Difusor: Acrílico

Acabamento: Dourado ou preto



Arandela articulável



Com interruptor na base



● **AR1600DO**

● **AR1600**

Arandela

LED 1x3W / 240 lm / 3000K  
Dim.: C210 x L120 x A355 mm  
Tensão: Bivolt (127V/220V)

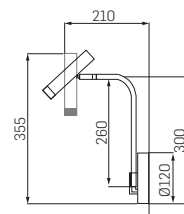

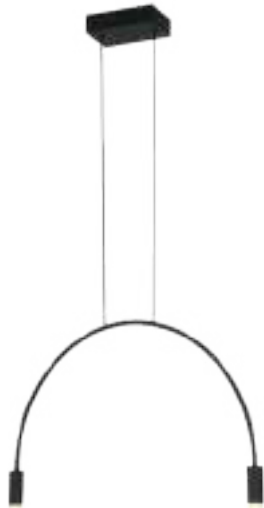

● PD1610DO

● PD1610

Pendente

6W (2x3W) / 480 lm / 3000K  
 Dim.: C600 x L30 x A370 mm  
 Tensão: Bivolt (127V/220V)  
 Cabo ajustável até 1500 mm

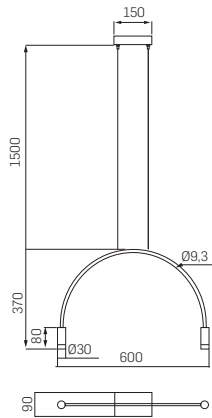

PD16102

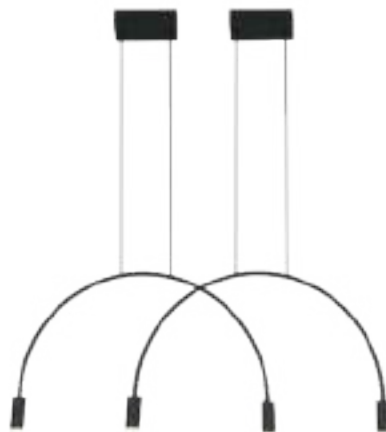

● PD16102DO

● PD16102

Pendente

12W (4x3W) / 960 lm / 3000K  
 Dim.: C900 x L30 x A370 mm  
 Tensão: Bivolt (127V/220V)  
 Cabo ajustável até 1500 mm

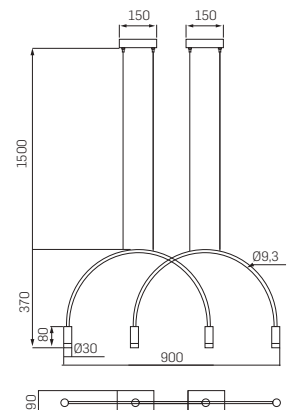



# Zione

Estrutura: Metal  
 Difusor: Acrílico  
 Acabamento: Dourado ou preto



Luminária de mesa e coluna articuláveis



● **LM1601DO**

● **LM1601**

Luminária de mesa

LED 1x3W / 240 lm / 3000K  
 Dim.: Ø160 x A480 mm  
 Tensão: Bivolt (127V/220V)  
 Cabo com 1500 mm

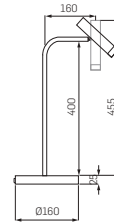

● **LM1489DO**

● **LM1489**

Luminária de mesa

LED 2x3W / 480 lm / 3000K  
 Dim.: Ø200 x A550 mm  
 Tensão: Bivolt (127V/220V)  
 Cabo com 1500 mm

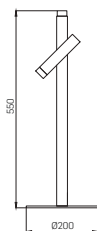

LM1601DO

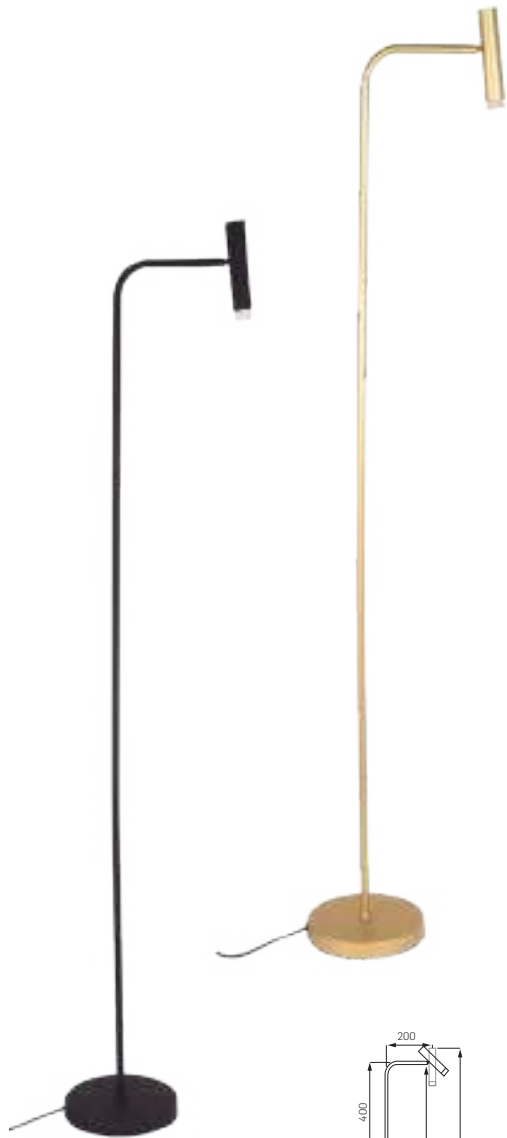

● **CL1602DO**

● **CL1602**

Coluna

LED 1x3W / 240 lm / 3000K  
 Dim.: Ø200 x A148 mm  
 Tensão: Bivolt (127V/220V)  
 Cabo com 1800 mm

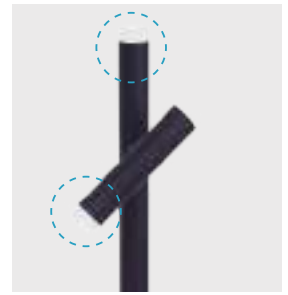
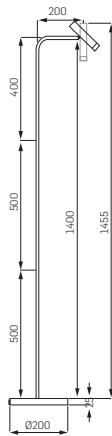

Luminária de mesa e coluna  
 com dois pontos de luz e  
 acendimento individual



● **CL1490DO**

● **CL1490**

Coluna

LED 2x3W / 480 lm / 3000K  
 Dim.: Ø250 x A1655 mm  
 Tensão: Bivolt (127V/220V)  
 Cabo com 1800 mm

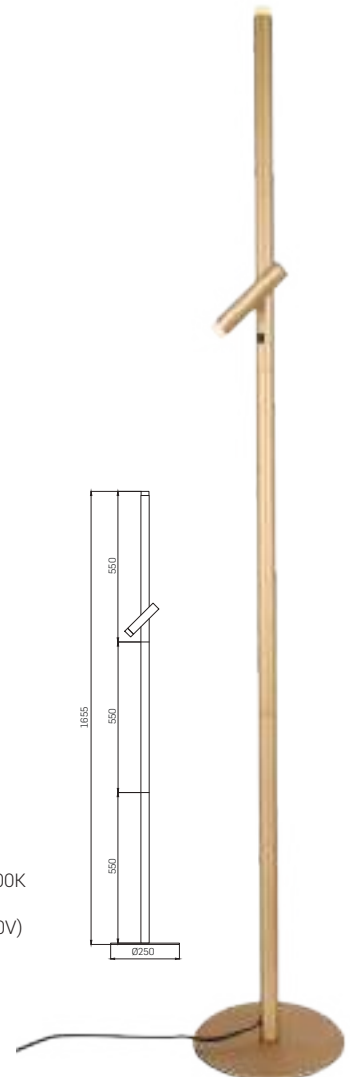
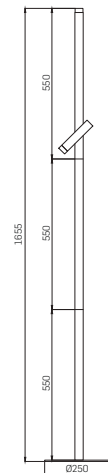

# Cannon

Estrutura: Metal preto

Acabamento detalhe: Preto ou Dourado

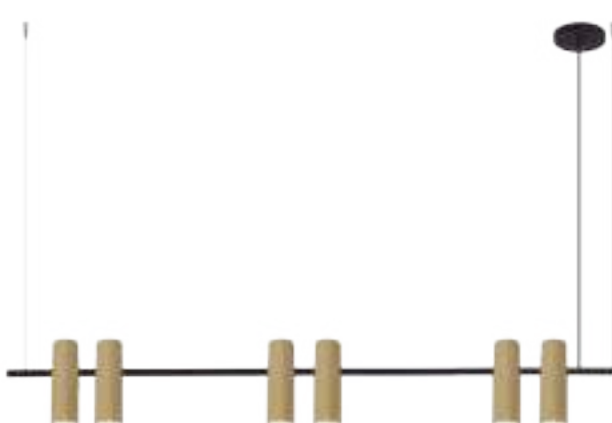
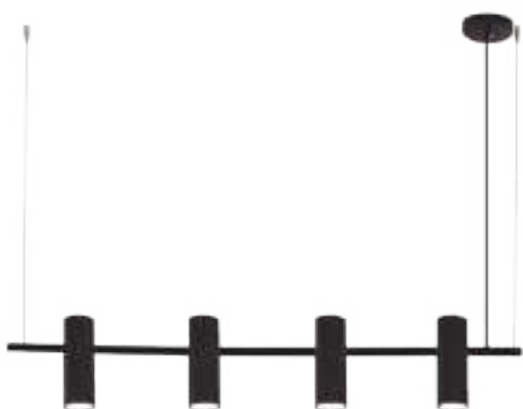

● **PD1632**

Pendente

4xGU10 50W

Dimensões: C1000 x L120 x A170 mm

Tensão: Bivolt (127V/220V)

Potência máxima: 200W

Cabo ajustável de até 1500 mm

● **PD1633DO**

Pendente

6xGU10 50W

Dimensões: C1300 x L120 x A170 mm

Tensão: Bivolt (127V/220V)

Potência máxima: 300W

Cabo ajustável de até 1500 mm

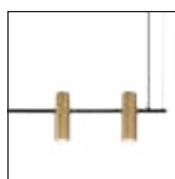
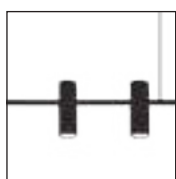

**PD1632**

Acabamento preto

**PD1632DO**

Acabamento dourado

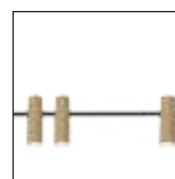
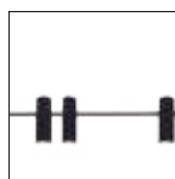

**PD1633**

Acabamento preto

**PD1633DO**

Acabamento dourado



PD1633DO

# Sears

Estrutura: Metal/cúpula de vidro  
 Difusor: Cúpula branca opalina  
 Acabamento: Dourado ou Preto



Possibilidade de ajuste de altura



● **PD1629DO**

Pendente

5xG9 Halopin 5W / 5 xGU10 50W  
 Dimensões: C1120 x L260 x A1150 mm  
 Tensão: Bivolt (127V/220V)  
 Potência máxima: 275W  
 Cabo ajustável até 1500 mm

● **PD1611DO**

Pendente

1xG9 Halopin 5W / 1 xGU10 50W  
 Dimensões: C200 x L120 x A1555 mm  
 Tensão: Bivolt (127V/220V)  
 Potência máxima: 55W

**Novo Acabamento**



**PD1629BR**  
 Acabamento branco



**PD1629DO**  
 Acabamento dourado



**PD1629PT**  
 Acabamento preto



**PD1611DO**  
 Acabamento dourado



**PD1611PT**  
 Acabamento preto



● **AR1628DO**

Arandela

1xG9 Halopin 5W / 1 xGU10 50W  
Dimensões: C235 x A200 mm  
Tensão: Bivolt (127V/220V)  
Potência máxima: 55W

**Novo Acabamento**



**AR1628BR**  
Acabamento branco



**AR1628DO**  
Acabamento dourado



**AR1628PT**  
Acabamento preto



AR1628BR

# Sears

Estrutura: Metal/cúpula de vidro  
 Difusor: Cúpula branca opalina  
 Acabamento: Dourado ou Preto



● **CL1630PT**  
 Coluna

1xG9 Halopin 5W / 1 xGU10 50W  
 Dimensões: C300 x L250 x A1163 mm  
 Tensão: Bivolt (127V/220V)  
 Potência máxima: 55W  
 Cabo com 1500 mm com interruptor liga e desliga para ser ligado a tomada



● **AB1631DO**  
 Abajur

1xG9 Halopin 5W / 1 xGU10 50W  
 Dimensões: C230 x L100 x A430 mm  
 Tensão: Bivolt (127V/220V)  
 Potência máxima: 55W  
 Cabo com 1500 mm com interruptor liga e desliga para ser ligado a tomada

Novo Acabamento



**CL1630BR**  
 Acabamento branco

**CL1630DO**  
 Acabamento dourado

**CL1630PT**  
 Acabamento preto

Novo Acabamento



**AB1631BR**  
 Acabamento branco

**AB1631DO**  
 Acabamento dourado

**AB1631PT**  
 Acabamento preto



AB1631DO



# Ludo

Estrutura: Alumínio

Difusor: Preto ou Dourado

Acabamento: Preto

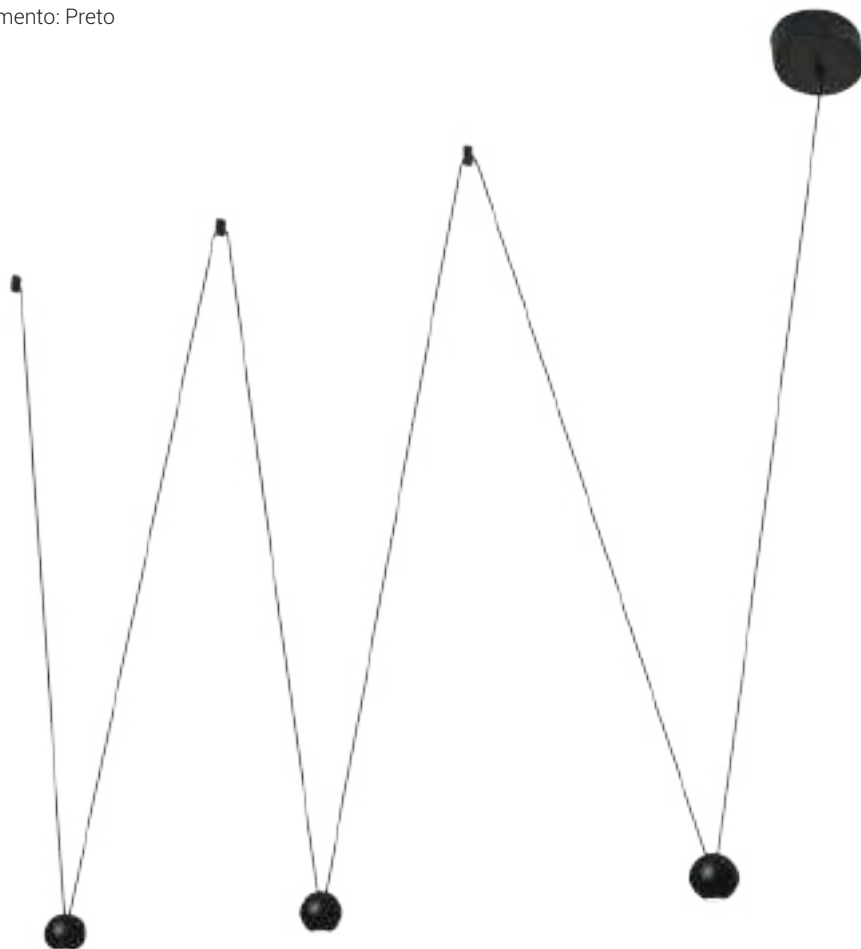

## ● PD1645PT

Pendente

LED 11W

Lúmens: 900lm

Temperatura: 3000K

Dimensões: Ø50 mm

Tensão: Bivolt (127V/220V)

Potência máxima: 11W

Cabo ajustável até 1500 mm



**PD1645DO**



**PD1645PT**



PD1645DO

# Sonik

Estrutura: Metal/Alumínio/ Acrílico

Acabamento: Dourado escovado



● **PD1658DO**

Pendente

LED 12W

Lúmens: 600lm

Temperatura: 3000K

Dimensões: C50 x A410 mm

Tensão: Bivolt (127V/220V)

Potência máxima: 12W

Cabo ajustável até 1500 mm



● **AR1657DO**

Arandela

LED 12W

Lúmens: 600lm

Temperatura: 3000K

Dimensões: C50 x A410 mm

Tensão: Bivolt (127V/220V)

Potência máxima: 12W



● **PD1659DO**

Pendente

LED 29W

Lúmens: 1450lm

Temperatura: 3000K

Dimensões: C1010 x A50 mm

Tensão: Bivolt (127V/220V)

Potência máxima: 29W

Cabo ajustável até 1500 mm



PD1659D0

# Twist

---

Estrutura: Metal / Acrílico  
Acabamento: Dourado



● **PD1734**  
Pendente

LED 75W  
Lúmens: 5250lm  
Temperatura: 3000K  
Dimensões: Ø650 x A113 mm  
Tensão: Bivolt (127V/220V)  
Potência máxima: 75W



PD1734

# Pectus

Estrutura: Alumínio  
 Difusor: Sílica gel branco  
 Acabamento: Dourado



● **AR1402**  
 Arandela

LED 11W / 880lm / 3000K  
 Dimensões: C395 x L145 x A120 mm  
 Tensão: Bivolt (127V/220V)

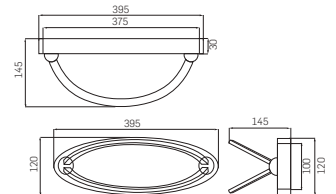

● **PD1401**  
 Pendente

LED 54W / 4320lm / 3000K  
 Dimensões: Ø800 x A160 mm  
 Tensão: Bivolt (127V/220V)  
 Cabo ajustável até 1500 mm

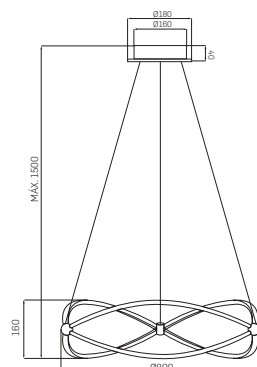



PD1401



# Eclipse

Estrutura: Metal + couro marrom

Difusor: Sílica gel

Acabamento: Dourado

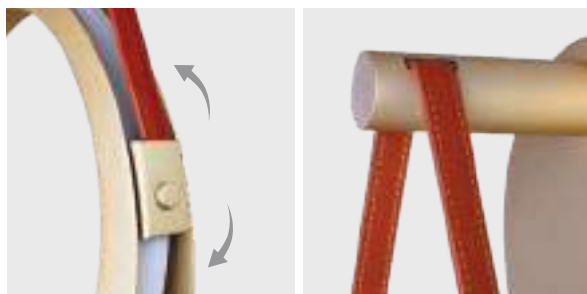

Iluminação em toda parte  
externa do aro



● **AR1504**

Arandela

13W / 780 lm / 3000K

Dimensões: Ø300 x L120 x A551 mm

Tensão: Bivolt (127V/220V)

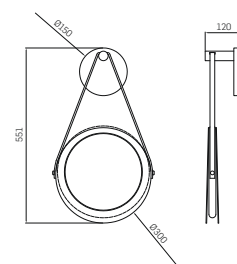



● **PD1505**  
Pendente

23W / 1380 lm / 3000K  
Dimensões: Ø400 x A1942 mm  
Tensão: Bivolt (127V/220V)  
Alça de couro ajustável até 1700 mm

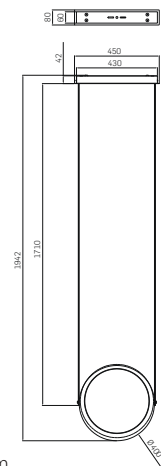

# Ritz

Estrutura: Metal/Alumínio/ Acrílico

Difusor: esfera branco opalino

Acabamento: Preto com detalhe dourado

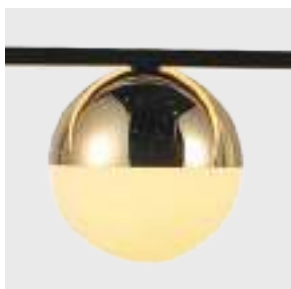

Detalhe do difusor em dourado



## ● PD1679

Pendente

LED 36W

Lúmens: 2520lm

Temperatura: 3000K

Dimensões: C1200 x L100 x A400 mm

Tensão: Bivolt (127V/220V)

Potência máxima: 36W

Cabo ajustável até 1500 mm

## ● PD1678

Pendente

LED 45W

Lúmens: 3150lm

Temperatura: 3000K

Dimensões: C1500 x L100 x A550 mm

Tensão: Bivolt (127V/220V)

Potência máxima: 45W

Cabo ajustável até 1500 mm



PD1678

# Allure

Estrutura: Metal / Acrílico

Difusor: Acrílico

Acabamento: Preto (onix) / Dourado

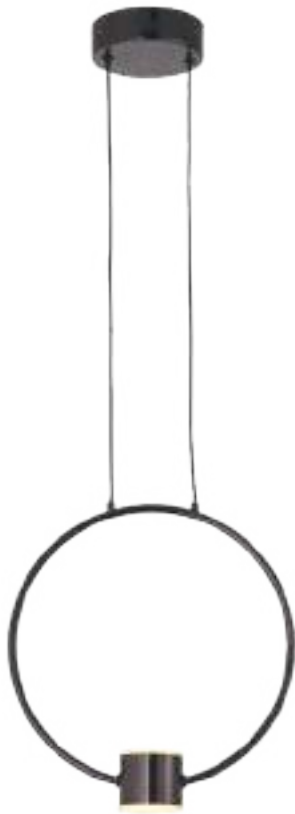

● **PD17000X**

Pendente

LED 2X5W

Lúmens: 800lm

Temperatura: 3000K

Dimensões: Ø300 x L65 mm

Tensão: Bivolt (127V/220V)

Potência máxima: 10W

Cabo ajustável até 2000 mm



● **PD1701DO**

Pendente

LED 2X5W

Lúmens: 800lm

Temperatura: 3000K

Dimensões: Ø500 x L65 mm

Tensão: Bivolt (127V/220V)

Potência máxima: 10W

Cabo ajustável até 2000 mm



**PD1700DO**

**PD17000X**

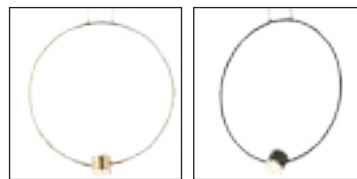

**PD1701DO**

**PD1701OX**

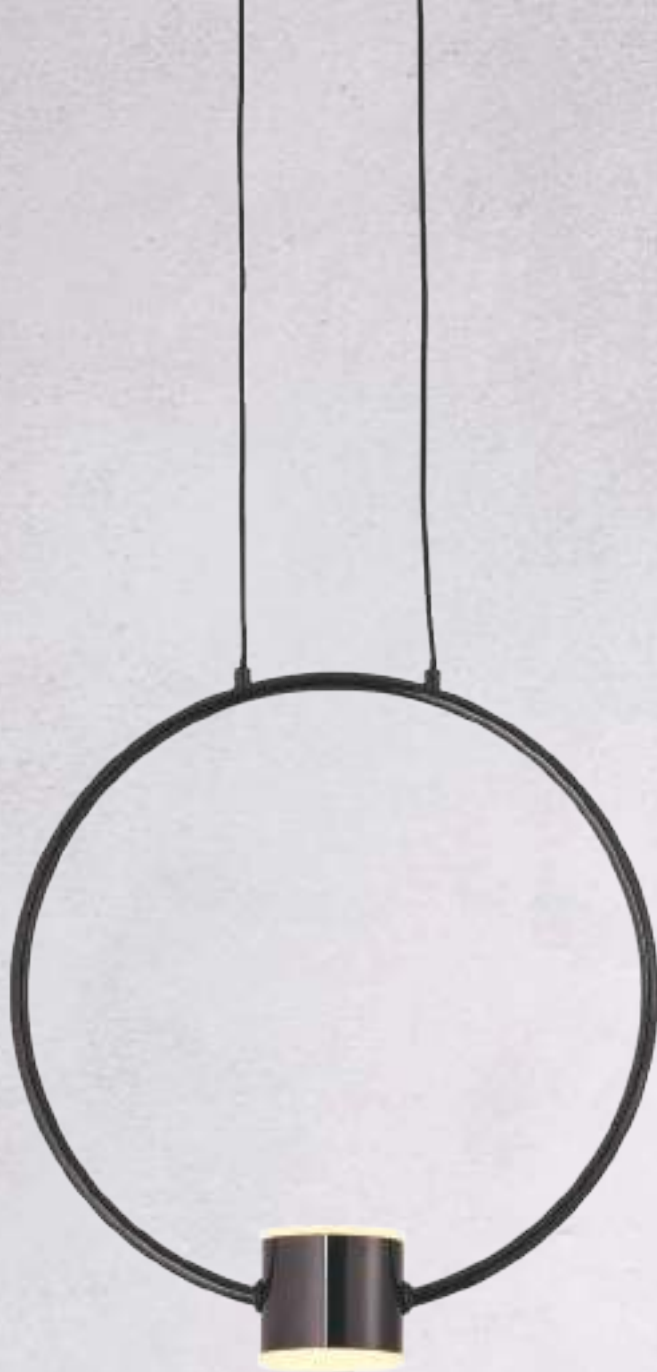

PD170000X

# Fusion

Estrutura: Metal/Alumínio/ Acrílico/ sílica gel

Acabamento: Preto ou dourado



● **PD1680DO**

Pendente

LED 36W

Lúmens: 2520lm

Temperatura: 3000K

Dimensões: C480 x L100 x A660 mm

Tensão: Bivolt (127V/220V)

Potência máxima: 36W

Cabo ajustável até 1500 mm



**PD1680DO**



**PD1680PT**



● **PD1681PT**  
Pendente

LED 36W  
Lúmens: 2520lm  
Temperatura: 3000K  
Dimensões: C710 x L100 x A516 mm  
Tensão: Bivolt (127V/220V)  
Potência máxima: 36W  
Cabo ajustável até 1500 mm



**PD1681DO**



**PD1681PT**



# Mallen

Estrutura: Alumínio/Difusor de sílica gel

Difusor: Difusor branco

Acabamento: Branco, Preto e Dourado



● **PD1627DO**

Pendente

LED: 36W

Lúmens: 2880lm

Temperatura: 3000K

Dimensões: C1200 x L38 x A200 mm

Tensão: Bivolt (127V/220V)

Potência máxima: 36W

Cabo: 1500 mm

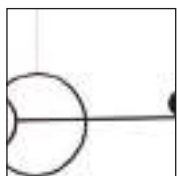

**PD1627PT**

Acabamento branco

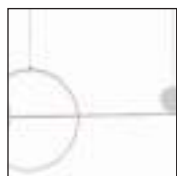

**PD1627BR**

Acabamento preto

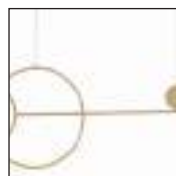

**PD1627DO**

Acabamento dourado



PD1627PT

# Valley

Estrutura: Alumínio

Acabamento: Preto ou Branco



● PD1692BR

● PD1692PT

Pendente

LED 40W

Lúmens: 1800lm

Temperatura: 3000K

Dimensões: Ø800 x A43 mm

Tensão: Bivolt (127V/220V)

Potência máxima: 40W

Cabo ajustável até 1500 mm



● PD1691BR

● PD1691PT

Pendente

LED 34W

Lúmens: 1530lm

Temperatura: 3000K

Dimensões: Ø600 x A43 mm

Tensão: Bivolt (127V/220V)

Potência máxima: 34W

Cabo ajustável até 1500 mm

COM EFEITO  
DE LUZ  
**DIRETA E  
INDIRETA**



PD1691BR

# Bert

Estrutura: Alumínio/ Silica gel

Acabamento: Preto, Branco ou Dourado



● **PD1735PT**

Pendente

LED 72W

Lúmens: 3240lm

Temperatura: 3000K

Dimensões: Ø600 + Ø800 x A15 mm

Tensão: Bivolt (127V/220V)

Potência máxima: 72W

Cabo ajustável até 1500 mm



**PD1735BR**

**PD1735PT**

**PD1735DO**



PD1735BR

# Rafik

Estrutura: Alumínio/Difusor de sílica gel

Difusor: Difusor branco

Acabamento: Branco, Preto ou Dourado



Canopla compacta exclusiva para forros de gesso



● **PL1619PT**

Plafon

LED: 10W

Lúmens: 800lm

Temperatura: 3000K

Dimensões: C300 x L18 x A200 mm

Tensão: Bivolt (127V/220V)

Potência máxima: 10W



● **PL1620PT**

Plafon

LED: 15W

Lúmens: 1200lm

Temperatura: 3000K

Dimensões: C500 x L80 x A300 mm

Tensão: Bivolt (127V/220V)

Potência máxima: 15W



**PL1619BR**

Acabamento branco



**PL1619PT**

Acabamento preto



**PL1619DO**

Acabamento dourado

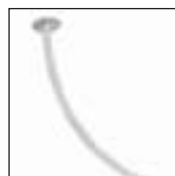

**PL1620BR**

Acabamento branco

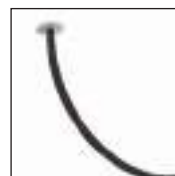

**PL1620PT**

Acabamento preto



**PL1620DO**

Acabamento dourado



● **PL1621PT**

Plafon

LED: 20W  
 Lúmens: 1600lm  
 Temperatura: 3000K  
 Dimensões: C700 x L18 x A400 mm  
 Tensão: Bivolt (127V/220V)  
 Potência máxima: 10W



**PL1621BR**  
Acabamento branco

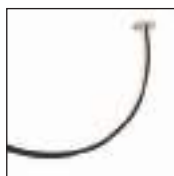

**PL1621PT**  
Acabamento preto



**PL1621DO**  
Acabamento dourado

**Sugestões de composição**

**A**

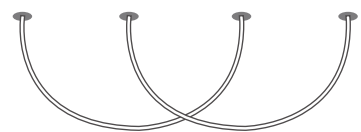

**B**

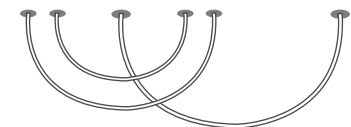

**C**

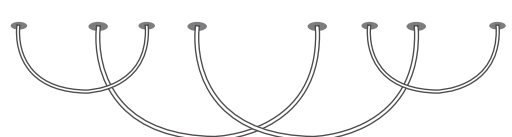



# Rafik

Estrutura: Alumínio/Difusor de sílica gel

Difusor: Difusor branco

Acabamento: Branco, Preto ou Dourado



Canopla compacta exclusiva para forros de gesso

## Sugestões de composição

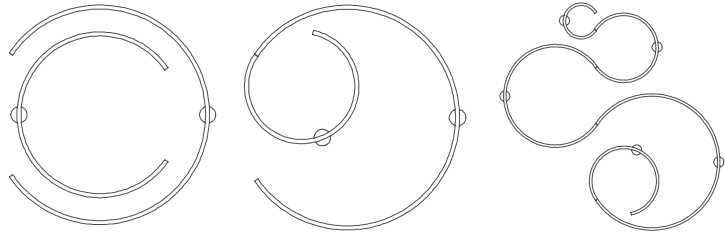

### ● PL1622BR

Plafon

LED: 8W

Lúmens: 640lm

Temperatura: 3000K

Dimensões: Ø200 x A20 mm

Tensão: Bivolt (127V/220V)

Potência máxima: 8W

### ● PL1623BR

Plafon

LED: 15W

Lúmens: 1200lm

Temperatura: 3000K

Dimensões: Ø400 x A20 mm

Tensão: Bivolt (127V/220V)

Potência máxima: 15W



**PL1622BR**

Acabamento branco



**PL1622PT**

Acabamento preto



**PL1622DO**

Acabamento dourado



**PL1623BR**

Acabamento branco



**PL1623PT**

Acabamento preto



**PL1623DO**

Acabamento dourado



● **PL1624BR**

Plafon

LED: 25W  
 Lúmens: 2000lm  
 Temperatura: 3000K  
 Dimensões: Ø600 x A20 mm  
 Tensão: Bivolt (127V/220V)  
 Potência máxima: 25W



**PL1624BR**  
Acabamento branco



**PL1624PT**  
Acabamento preto



**PL1624DO**  
Acabamento dourado



● **PL1625BR**

Plafon

LED: 30W  
 Lúmens: 2400lm  
 Temperatura: 3000K  
 Dimensões: Ø800 x A20 mm  
 Tensão: Bivolt (127V/220V)  
 Potência máxima: 30W



**PL1625BR**  
Acabamento branco



**PL1625PT**  
Acabamento preto



**PL1625DO**  
Acabamento dourado

# Quebec

Estrutura: Metal, detalhes em alumínio/

Difusor de sílica gel

Difusor: Difusor branco

Acabamento: Branco, Preto, Dourado

ou Cobre



## ● QPD1435CO

Pendente

LED: 45W

Lúmens: 1962lm

Temperatura: 3000K

Dimensões: Ø400+Ø500 x A20 mm

Tensão: Bivolt (127V/220V)

Potência máxima: 45W

Cabo ajustável até 1500 mm



**QPD1435BR**

Acabamento branco



**QPD1435PT**

Acabamento preto

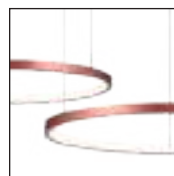

**QPD1435CO**

Acabamento cobre



**QPD1435DO**

Acabamento dourado



QPD1435PT

# Quebec

Estrutura: Alumínio/Difusor de sílica gel

Difusor: Difusor branco

Acabamento: Branco, Preto, Dourado  
ou Cobre



● **QAR1436PT**

Arandela/Plafon

LED: 15W

Lúmens: 650lm

Temperatura: 3000K

Dimensões: Ø300 mm

Tensão: Bivolt (127V/220V)

Potência máxima: 15W



**QAR1436BR**  
Acabamento branco

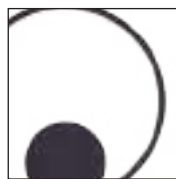

**QAR1436PT**  
Acabamento preto

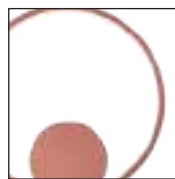

**QAR1436CO**  
Acabamento cobre



**QAR1436DO**  
Acabamento dourado





# Montreal

Estrutura: Alumínio/Difusor de sílica gel

Difusor: branco

Acabamento: Branco, Preto, Dourado  
ou Cobre



● **QPD1301-PT**  
Pendente

LED: 25W + 15W  
Lúmens: 2254lm  
Temperatura: 3000K  
Dimensões: Ø500 + Ø300 x A20 mm  
Tensão: Bivolt (127V/220V)  
Potência máxima: 40W  
Cabo ajustável até 1500 mm



**QPD1301-BR**  
Acabamento branco

**QPD1301-PT**  
Acabamento preto

**QPD1301-CO**  
Acabamento cobre

**QPD1301-DO**  
Acabamento dourado



● **QPD1303-DO**

Pendente

LED: 24W + 30W + 35W

Lúmens: 4181lm

Temperatura: 3000K

Dimensões: Ø600 + Ø500 + Ø400 x A20 mm

Tensão: Bivolt (127V/220V)

Potência máxima: 89W

Cabo ajustável até 1500 mm



**QPD1303-BR**  
Acabamento branco



**QPD1303-PT**  
Acabamento preto



**QPD1303-CO**  
Acabamento cobre



**QPD1303-DO**  
Acabamento dourado



# Orgon

Estrutura: Alumínio/Difusor de sílica gel

Difusor: Difusor branco

Acabamento: Branco, Preto, Dourado  
ou Cobre



● **PD1424PT**  
Pendente

LED: 45W

Lúmens: 2500lm

Temperatura: 3000K

Dimensões: Ø500 x A180 mm

Tensão: Bivolt (127V/220V)

Potência máxima: 45W

Cabo ajustável até 1500 mm



**PD1424BR**  
Acabamento branco

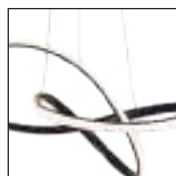

**PD1424PT**  
Acabamento preto



**PD1424CO**  
Acabamento cobre



**PD1424DO**  
Acabamento dourado



PD1623BR

● **PD1423CO**  
Pendente

LED: 58W  
Lúmens: 2800lm  
Temperatura: 3000K  
Dimensões: Ø800 xA180 mm  
Tensão: Bivolt (127V/220V)  
Potência máxima: 58W  
Cabo ajustável até 1500 mm



**PD1423BR**  
Acabamento branco



**PD1423PT**  
Acabamento preto



**PD1423CO**  
Acabamento cobre



**PD1423DO**  
Acabamento dourado

# Lace

Estrutura: Alumínio/Difusor de sílica gel

Difusor: Difusor branco

Acabamento: Preto ou Dourado



● **PD1425DO**

Pendente

LED: 36W

Lúmens: 1500lm

Temperatura: 3000K

Dimensões: C1000 x L250 x A250 mm

Tensão: Bivolt (127V/220V)

Potência máxima: 36W

Cabo ajustável até 1500 mm



**PD1425PT**

Acabamento preto



**PD1425DO**

Acabamento dourado

# Worm

Estrutura: Alumínio/Difusor de sílica gel  
 Difusor: Difusor branco  
 Acabamento: Branco, Preto, Dourado  
 ou Cobre



PD1427DO



● **AR1426BR**

Arandela

LED: 10W  
 Lúmens: 770lm  
 Temperatura: 3000K  
 Dimensões: C160 x L140 x A320 mm  
 Tensão: Bivolt (127V/220V)  
 Potência máxima: 10W

● **PD1427DO**

Pendente

LED: 30W  
 Lúmens: 1300lm  
 Temperatura: 3000K  
 Dimensões: Ø180 x A550 mm  
 Tensão: Bivolt (127V/220V)  
 Potência máxima: 30W  
 Cabo ajustável até 1500 mm



**AR1426BR**  
 Acabamento branco



**AR1426PT**  
 Acabamento preto



**AR1426CO**  
 Acabamento cobre



**AR1426DO**  
 Acabamento dourado



**PD1427DO**  
 Acabamento  
 dourado



**PD1427PT**  
 Acabamento preto

# Twine

Estrutura: Alumínio/Difusor de sílica gel  
 Difusor: Difusor branco  
 Acabamento: Branco, Preto, Dourado  
 ou Cobre



QPD1339PT



● **QPD1339DO**  
 Pendente

LED: 15W  
 Lúmens: 900lm  
 Temperatura: 3000K  
 Dimensões: C880 x A70 mm  
 Tensão: Bivolt (127V/220V)  
 Potência máxima: 15W  
 Cabo ajustável até 1500 mm

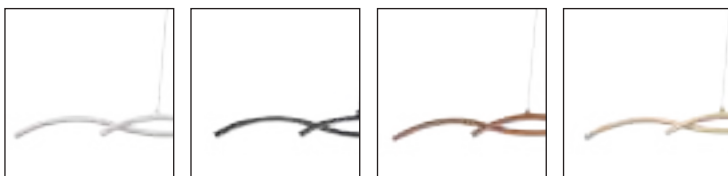

**QPD1339BR**  
 Acabamento branco

**QPD1339PT**  
 Acabamento preto

**QPD1339CO**  
 Acabamento cobre

**QPD1339DO**  
 Acabamento dourado

# Tagne

Estrutura: Alumínio/Difusor de sílica gel

Difusor: Difusor branco

Acabamento: Branco, Preto e Dourado



Canopla compacta exclusiva para forros de gesso



PD1626BR

## ● PD1626PT

Pendente

LED: 24W

Lúmens: 1920lm

Temperatura: 3000K

Dimensões: C900 x L38 x A100 mm

Tensão: Bivolt (127V/220V)

Potência máxima: 24W

Cabo ajustável até 1500 mm



**PD1626BR**  
Acabamento branco

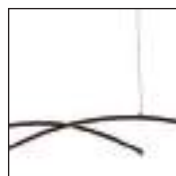

**PD1626PT**  
Acabamento preto



**PD1626DO**  
Acabamento dourado

# Hoop

Estrutura: Alumínio/Difusor de sílica gel

Difusor: Difusor branco

Acabamento: Branco, Preto, Dourado  
ou Cobre



● **QPD1321BR**  
Pendente

LED: 16W  
Lúmens: 688lm  
Temperatura: 3000K  
Dimensões: C120 x A35 mm  
Tensão: Bivolt (127V/220V)  
Potência máxima: 16W  
Cabo ajustável até 1500 mm

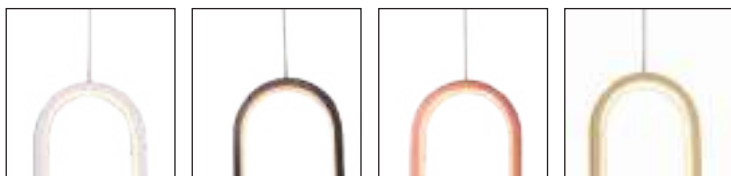

**QPD1321BR**  
Acabamento branco

**QPD1321PT**  
Acabamento preto

**QPD1321CO**  
Acabamento cobre

**QPD1321DO**  
Acabamento dourado



QPD1321PT



# Volpi

Estrutura: Metal/ Alumínio/ Sílica gel  
Acabamento: Preto, branco ou dourado



● **AR1669PT**  
Arandela

LED 10W  
Lúmens: 700lm  
Temperatura: 3000K  
Dimensões: C140 x L22 x A650 mm  
Tensão: Bivolt (127V/220V)  
Potência máxima: 10W



**AR1669BR**



**AR1669PT**

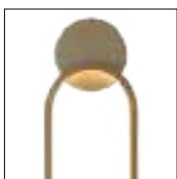

**AR1669DO**



AR1669PT

# Kira

Estrutura: Alumínio/ Sílica gel

Acabamento: Preto, branco ou dourado

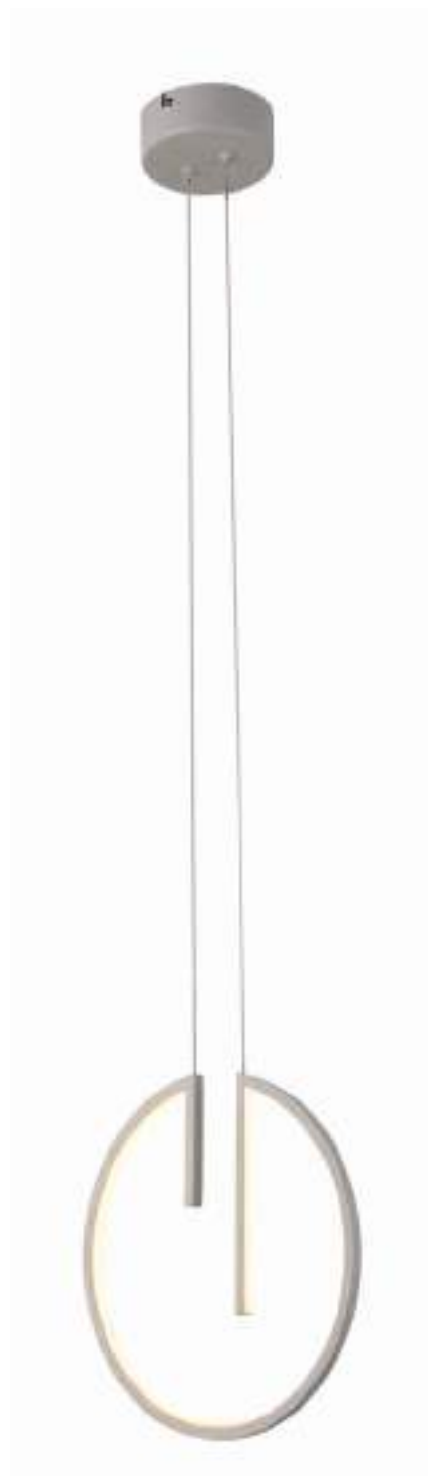
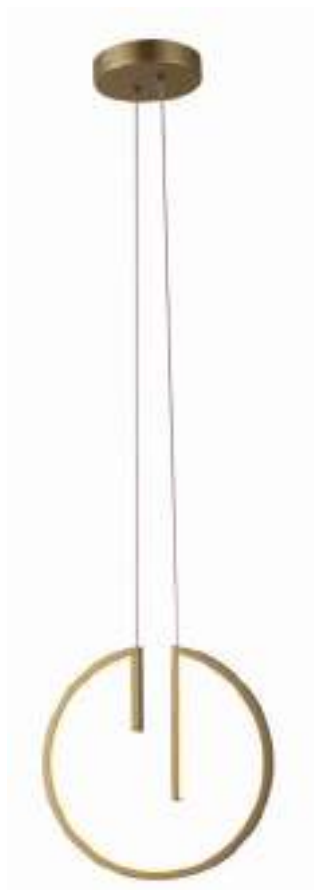
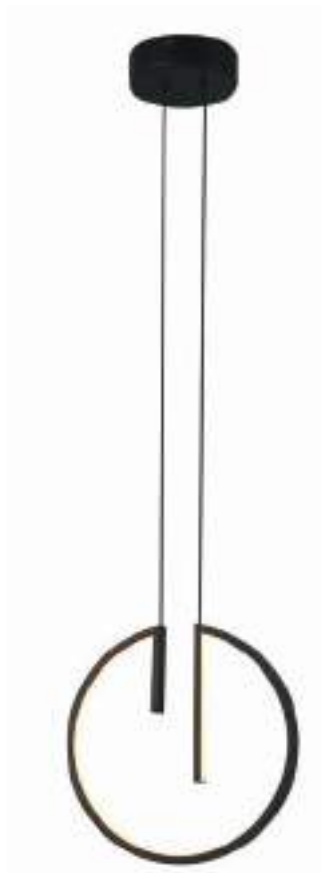

● **PD1617PT**

Pendente

LED 18W

Lúmens: 1260lm

Temperatura: 3000K

Dimensões: C240 x L20 x A238 mm

Tensão: Bivolt (127V/220V)

Potência máxima: 18W

Cabo ajustável até 1500 mm



**PD1617BR**

**PD1617PT**

**PD1617DO**



PT1617PT

# Avis

---

Estrutura: Alumínio/ Sílica gel

Acabamento: Preto, branco ou dourado



● **AR1689DO**  
Arandela

LED 15W

Lúmens: 1050lm

Temperatura: 3000K

Dimensões: C600 x L35 x A148 mm

Tensão: Bivolt (127V/220V)

Potência máxima: 15W



**AR1689BR**

**AR1689PT**

**AR1689DO**



● **AR1690PT**

Arandela

LED 20W

Lúmens: 1400lm

Temperatura: 3000K

Dimensões: C1000 x L35 x A290 mm

Tensão: Bivolt (127V/220V)

Potência máxima: 20W



**AR1690BR**

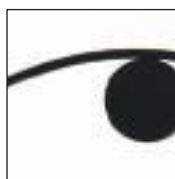

**AR1690PT**



**AR1690DO**

# Calla

---

Estrutura: Metal/Alumínio/ Acrílico

Acabamento: Preto, Branco ou Dourado



● **AR1653DO**

Arandela

LED 6W  
Lúmens: 300lm  
Temperatura: 3000K  
Dimensões: Ø150 mm  
Tensão: Bivolt (127V/220V)  
Potência máxima: 6W



● **AR1655PT**

Arandela

LED 6W  
Lúmens: 300lm  
Temperatura: 3000K  
Dimensões: C120 x L40 x A110 mm  
Tensão: Bivolt (127V/220V)  
Potência máxima: 6W



**AR1653BR**

**AR1653PT**

**AR1653DO**

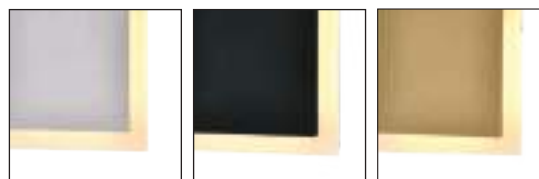

**AR1655BR**

**AR1655PT**

**AR1655DO**



● **PD1652BR**

Pendente

LED 6W  
 Lúmens: 300lm  
 Temperatura: 3000K  
 Dimensões: Ø150 mm  
 Tensão: Bivolt (127V/220V)  
 Potência máxima: 6W  
 Cabo ajustável até 1500 mm



**PD1652BR**



**PD1652PT**



**PD1652PT**



● **PD1654PT**

Pendente

LED 6W  
 Lúmens: 300lm  
 Temperatura: 3000K  
 Dimensões: C120 x L10 x A110 mm  
 Tensão: Bivolt (127V/220V)  
 Potência máxima: 6W  
 Cabo ajustável até 1500 mm



**PD1654BR**



**PD1654PT**



**PD1654DO**



# Dover

Estrutura: Alumínio  
 Disco: Branco  
 Acabamento: Preto / Dourado



● **PL1644PT**  
 Plafon

LED 10.5W  
 Lúmens: 1100lm  
 Temperatura: 3000K  
 Dimensões: Ø300 x A223 mm  
 Tensão: Bivolt (127V/220V)  
 Potência máxima: 10.5W

● **PD1643DO**  
 Pendente

LED 10.5W  
 Lúmens: 1050lm  
 Temperatura: 3000K  
 Dimensões: Ø400 x A580 mm  
 Tensão: Bivolt (127V/220V)  
 Potência máxima: 10.5W  
 Cabo ajustável até 1500 mm



**PL1644DO**

**PL1644PT**

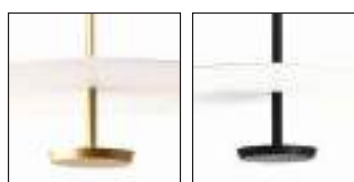

**PD1643DO**

**PD1643PT**



PD1643PT

# Asha

---

Estrutura: Metal/Alumínio/ Acrílico

Acabamento: Preto ou Branco



● **PL1656BR**  
Plafon/Arandela

LED 30W  
Lúmens: 1500lm  
Temperatura: 3000K  
Dimensões: C800 x L660 x P85 mm  
Tensão: Bivolt (127V/220V)  
Potência máxima: 30W



**PL1656BR**

**PL1656PT**



PL1656PT

# Berla

---

Estrutura: Metal/acrílico

Acabamento: Branco



● **PL1749**

Plafon

LED 33W

Lúmens: 2376lm

Temperatura: 3000K

Dimensões: C620 x L500 x P50 mm

Tensão: Bivolt (127V/220V)

Potência máxima: 4W



● **PL1750**

Plafon

LED 31W

Lúmens: 2232lm

Temperatura: 3000K

Dimensões: C600 x L580 x P50 mm

Tensão: Bivolt (127V/220V)

Potência máxima: 4W



# Dupe

Estrutura: Metal/ Acrílico

Acabamento: Branco



● **PL1664**

Plafon

LED 22W

Lúmens: 1500lm

Temperatura: 3000K

Dimensões: C545 x L405 x A50 mm

Tensão: Bivolt (127V/220V)

Potência máxima: 22W



# Luft

---

Estrutura: Metal/ Acrílico

Acabamento: Branco



● **PL1666**  
Plafon

LED 60W  
Lúmens: 3900lm  
Temperatura: 3000K  
Dimensões: C750 x L500 x A80 mm  
Tensão: Bivolt (127V/220V)  
Potência máxima: 60W



# Mob

Estrutura: Metal/ Acrílico

Acabamento: Branco fosco / Preto fosco



● **PL1663PT**  
Plafon

LED 24W  
Lúmens: 1600lm  
Temperatura: 3000K  
Dimensões: C400 x L305 x A30 mm  
Tensão: Bivolt (127V/220V)  
Potência máxima: 18W



● **PL1662BR**  
Plafon

LED 18W  
Lúmens: 1200lm  
Temperatura: 3000K  
Dimensões: C300 x L210 x A30 mm  
Tensão: Bivolt (127V/220V)  
Potência máxima: 18W



**PL1663BR**

**PL1663PT**

**PL1663DO**



**PL1662BR**

**PL1662PT**

**PL1662DO**



PL1662DO / PL1663DO

# Space

Estrutura: Metal / Plástico

Acabamento: Preto



Cúpula rotativa



● **AR1703**

Arandela

1x G9 Halopin 40W

Dimensões: Ø293 x L95 x A355 mm

Tensão: Bivolt (127V/220V)

Potência máxima: 40W

Possui cabo com 1300 mm com interruptor liga e desliga para ser ligado a tomada



● **LM1702**

Luminária de mesa

1x G9 Halopin 40W

Dimensões: Ø305 x L180 x A430 mm

Tensão: Bivolt (127V/220V)

Potência máxima: 40W

Possui cabo com 1800 mm com interruptor liga e desliga para ser ligado a tomada

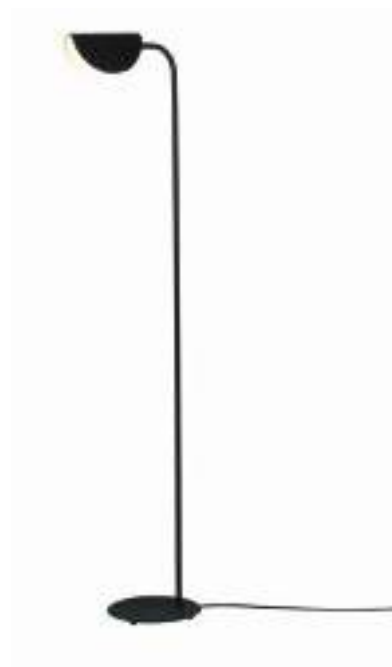

● **CL1704**

Coluna

1x G9 Halopin 40W

Dimensões: Ø325 x L230 x A1400 mm

Tensão: Bivolt (127V/220V)

Potência máxima: 40W

Possui cabo com 2100 mm com interruptor liga e desliga para ser ligado a tomada



CL1704



● **PD1705**

Pendente

1x G9 Halopin 40W  
Dimensões: Ø230 x L95 x A1500 mm  
Tensão: Bivolt (127V/220V)  
Potência máxima: 40W  
Cabo ajustável até 1500 mm



● **PD1706**

Pendente

6x G9 Halopin 40W  
Dimensões: Ø1250 x A1030 mm  
Tensão: Bivolt (127V/220V)  
Potência máxima: 240W  
Cabo ajustável até 1500 mm

# Ricci

Estrutura: Metal / Vidro

Difusor: Vidro champagne e transparente

Acabamento: Dourado



Detalhe do vidro



● **PD1616**  
Pendente

29x G9 Halopin LED 5W  
Dimensões: Ø820 x A1660 mm  
Tensão: Bivolt (127V/220V)  
Potência máxima: 145W  
Cabo ajustável até 1500 mm



PD1616



# Aura

---

Estrutura: Metal / Vidro  
Difusor: Champagne  
Acabamento: Dourado



● **PD1614**  
Pendente

15xG9 Halopin LED 5W  
Dimensões: Ø900 x A250 mm  
Tensão: Bivolt (127V/220V)  
Potência máxima: 75W  
Cabo ajustável até 1500 mm



● **PD1615**  
Pendente

24xG9 Halopin LED 5W  
Dimensões: Ø1250 x A250 mm  
Tensão: Bivolt (127V/220V)  
Potência máxima: 75W  
Cabo ajustável até 1500 mm



PD1615



# Blasen

Estrutura: Metal/Alumínio/ Vidro

Difusor: Fumê ou Champagne

Acabamento: Preto ou Dourado



Detalhe da iluminação da barra



● **PD1725PT**

Pendente

LED 37W

Lúmens: 2300lm

Potência: 3000K

Dimensões: C1200 x L220 x A1650 mm

Tensão: Bivolt (127V/220V)

Potência máxima: 37W

Cabo ajustável até 1500 mm



**PD1725DO**



**PD1725PT**



PD1725PT

# Cosmos

Estrutura: Metal/cúpula de vidro

Difusor: Cúpula champagne /

Cúpula branca

Acabamento: Bronze / Preto



## ● PD1430BR

Pendente

8xG9 Halopin 5W  
Dimensões: C900 x L670 x A450 mm  
Tensão: Bivolt (127V/220V)  
Potência máxima: 40W  
Cabo ajustável até 1500 mm



## ● PD1430PTBR

Pendente

8xG9 Halopin 5W  
Dimensões: C900 x L670 x A450 mm  
Tensão: Bivolt (127V/220V)  
Potência máxima: 40W  
Cabo ajustável até 1500 mm

LANÇAMENTO 2022



### PD1430CH

8 esfera champagne

### PD1430BR

8 esfera branco opalino



### PD1430PTBR

8 esfera champagne

### PD1430PTTR

8 esfera branco opalino

### PD1430PTCH

8 esfera branco opalino



● **PD1431CH**

Pendente

6xG9 Halopin 5W

Dimensões: C1100 x L380 x A380 mm

Tensão: Bivolt (127V/220V)

Potência máxima: 30W

Cabo ajustável até 1500 mm



**PD1431CH**  
6 esfera champagne



**PD1431BR**  
6 esfera branco  
opalino

# Atomy

Estrutura: Metal/cúpula de vidro

Difusor: Cúpula craquelê /  
cúpula branca

Acabamento: Cobre



● **PD1269**

Pendente

12xG9 Halopin (LED) 5W  
Dimensões: Ø775 x A370 mm  
Tensão: Bivolt (127V/220V)  
Potência máxima: 60W  
Cabo ajustável até 1500 mm



**PD1269**

12 cúpulas craquelê



**PD1269BR**

12 cúpulas brancas  
opalinas





PD1269BR

# DNA

Estrutura: Metal/cúpula de vidro

Difusor: Cúpula transparente (interno fosco)

Acabamento: Cobre



PD1298



● **PD1298**  
Pendente

12xG9 Halopin 5W  
Dimensões: C680 x L270 x A330 mm  
Tensão: Bivolt (127V/220V)  
Potência máxima: 60W  
Cabo ajustável até 1500 mm



● **PD1298G**  
Pendente

16xG9 Halopin 5W  
Dimensões: C800 x L250 x A400 mm  
Tensão: Bivolt (127V/220V)  
Potência máxima: 80W  
Cabo ajustável até 1500 mm

# Hunt

Estrutura: Metal/cúpula de vidro  
Difusor: Cúpula transparente/cúpula interna fosca  
Acabamento: Preto (Detalhes em cobre)



## ● AR1264

Arandela

2xG9 Halopin (LED) 5W  
Dimensões: C120 x L270 x A370 mm  
Tensão: Bivolt (127V/220V)  
Potência máxima: 10W



## ● PD1262

Pendente

8xG9 Halopin 5W  
Dimensões: Ø590 xA500 mm  
Tensão: Bivolt (127V/220V)  
Potência máxima: 40W  
Haste ajustável até 760 mm



PD1262



# Pinot

---

Estrutura: Metal/vidro

Difusor: Branco opalino / fumê /  
champagne

Acabamento: Preto, branco ou dourado



● **AR1670BR**

Arandela

2x G9 5W

Dimensões: Ø330 x A460 mm

Tensão: Bivolt (127V/220V)

Potência máxima: 10W



**AR1670BR**



**AR1670PT**



**AR1670DO**



AR1671DO



● **AR1671DO**

Arandela

4x G9 5W

Dimensões: Ø400 x A950 mm

Tensão: Bivolt (127V/220V)

Potência máxima: 20W



**AR1671BR**



**AR1671PT**



**AR1671DO**

# Pinot

Estrutura: Metal/vidro

Difusor: Branco opalino / fumê /  
champagne

Acabamento: Preto, branco ou dourado



## ● CL1673DO

Coluna

7x G9 5W

Dimensões: Ø370 x A1750 mm

Tensão: Bivolt (127V/220V)

Potência máxima: 35W

Possui cabo com 2050 mm com interruptor liga e  
desliga para ser ligado a tomada



CL1673BR



CL1673PT



CL1673DO



CL1673PT



AB1672PT



● **AB1672DO**

Abajur

2x G9 5W

Dimensões: Ø240 x A470 mm

Tensão: Bivolt (127V/220V)

Potência máxima: 10W

Possui cabo com 1700 mm com interruptor liga e desliga para ser ligado a tomada



**AB1672BR**



**AB1672PT**



**AB1672DO**

# Pinot

Estrutura: Metal/vidro

Difusor: Branco opalino fumê champagne

Acabamento: Preto, branco ou dourado

Duas opções de montagem\*



2 Opções de Montagem

## ● PD1674PT

Pendente

5x G9 5W

Dimensões: C1300 x L335 x A400 mm

Tensão: Bivolt (127V/220V)

Potência máxima: 25W

Cabo ajustável até 2000 mm



PD1674BR



PD1674PT

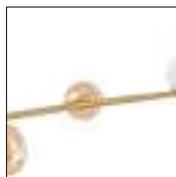

PD1674DO

\*Para outra opção de montagem, remova o cabo de aço, mantendo o pendente na vertical



PD1674BR

● **PD1675BR**  
Pendente

7x G9 5W  
Dimensões: C1750 x L335 x A400 mm  
Tensão: Bivolt (127V/220V)  
Potência máxima: 35W  
Cabo ajustável até 2000 mm



**PD1675BR**

**PD1675PT**

**PD1675DO**

\*Para outra opção de montagem, remova o cabo de aço, mantendo o pendente na vertical



2 Opções de Montagem

# Neolus

Estrutura: Metal/cúpula de vidro

Difusor: Cúpula Branca

Acabamento: Dourado



● **AR1459**

Arandela

2xG9 (LED) 5W

Dimensões: C230 x L130 x A350 mm

Tensão: Bivolt (127V/220V)

Potência máxima: 10W



● **PD1461**

Pendente

9xG9 5W

Dimensões: Ø920 x A515 mm

Tensão: Bivolt (127V/220V)

Potência máxima: 45W

Haste ajustável até 620 mm



PD1461



# Colli

Estrutura: Metal

Difusor: Vidro branco opalino

Acabamento: Dourado ou preto



Pendente e plafon com hastes ajustáveis



● **AR1513DO**

● **AR1513PT**

Arandela

2xG9 5W

Potência máxima: 10W

Dimensões: C120 x A673 mm

Difusor: 2xØ150mm

Tensão: Bivolt (127V/220V)

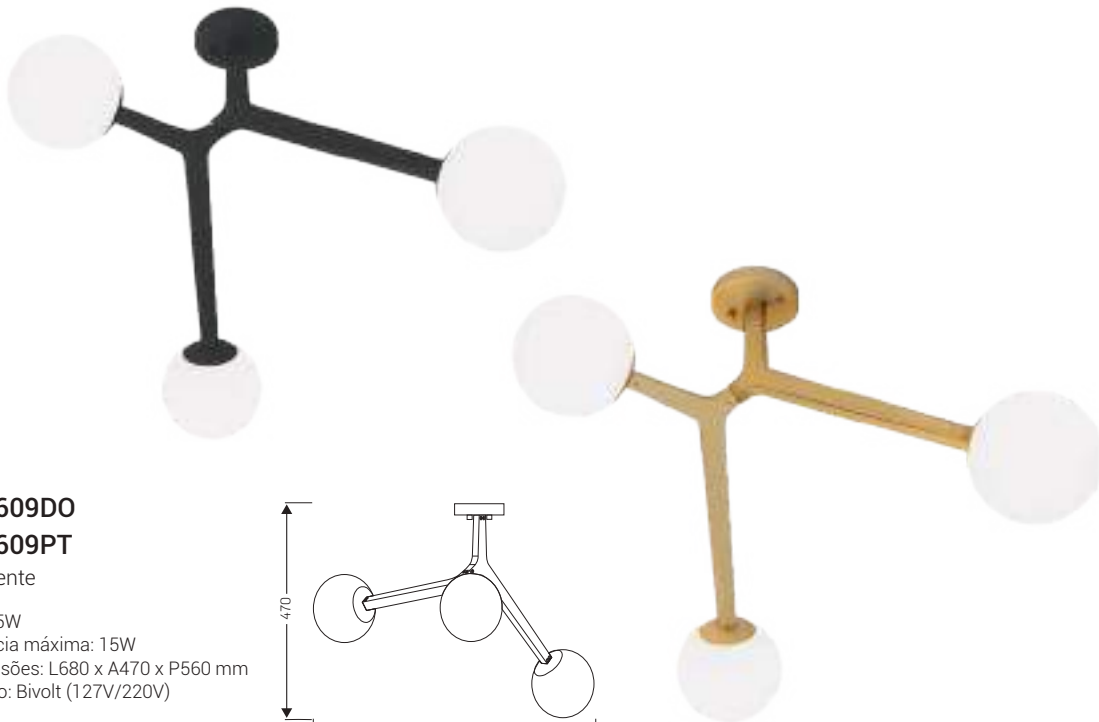
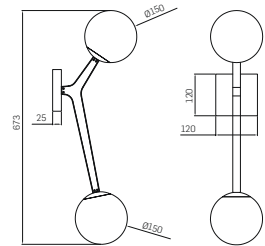

● **PL1609DO**

● **PL1609PT**

Pendente

3xG9 5W

Potência máxima: 15W

Dimensões: L680 x A470 x P560 mm

Tensão: Bivolt (127V/220V)

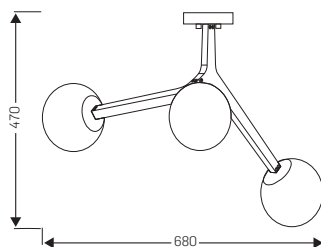



● PD1514DO

● PD1514PT

Pendente

10xG9 5W

Potência máxima: 50W

Dimensões: C1751 x A383 mm

Difusor: 5xØ138 / 5xØ150 mm

Tensão: Bivolt (127V/220V)

Cabo ajustável até 2000 mm

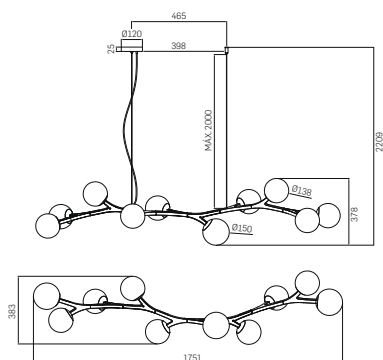



PD1514PT



AR1513DO

# Orbit

Estrutura: Alumínio/cúpula de vidro  
 Difusor: Opalino, Champagne ou Mistó  
 (opalino interno e cristal externo)  
 Acabamento: Dourado fosco ou preto fosco

- Canopla para instalação em forros de gesso
- Compatível com tampa de caixa de passagem NAC00137 para instalação em lajes (vendida separadamente)

\*A dimensão total do produto irá variar de acordo com a esfera utilizada



## ● PDH1527PT

Pendente

6xG9 Halopin LED 5W  
 Dimensões: C1050 x L265 x A160 mm  
 Tensão: Bivolt (127V/220V)  
 Potência máxima: 30W  
 Cabo ajustável até 1500 mm



PDH1527PT



## ● PDH1527DO

Pendente

6xG9 Halopin LED 5W  
 Dimensões: C1050 x L265 x A160 mm  
 Tensão: Bivolt (127V/220V)  
 Cabo ajustável até 1500 mm



**PDH1527PT**  
 2 esferas de 10cm e  
 4 esferas de 12cm

**PDH1527TRPT**  
 \*6 esferas de 12cm

**PDH1527CHPT**  
 2 esferas de 10cm e  
 4 esferas de 12cm



**PDH1527DO**  
 2 esferas de 10cm e  
 4 esferas de 12cm

**PDH1527TRDO**  
 \*6 esferas de 12cm

**PDH1527CHDO**  
 2 esferas de 10cm e  
 4 esferas de 12cm



PDH1576DO



● **PDH1576CHDO**

Pendente

8xG9 Halopin LED 5W  
 Dimensões: C1450 x L265 x A170 mm  
 Tensão: Bivolt (127V/220V)  
 Potência máxima: 40W  
 Cabo ajustável até 1500 mm



● **PDH1576PT**

Pendente

8xG9 Halopin LED 5W  
 Dimensões: C1450 x L265 x A170 mm  
 Tensão: Bivolt (127V/220V)  
 Potência máxima: 40W  
 Cabo ajustável até 1500 mm



**PDH1576DO**  
8 esferas de 12cm

**PDH1576TRDO**  
8 esferas de 12cm

**PDH1576CHDO**  
8 esferas de 12cm



**PDH1576PT**  
8 esferas de 12cm

**PDH1576TRPT**  
8 esferas de 12cm

**PDH1576CHPT**  
8 esferas de 12cm

# Orbit

Estrutura: Alumínio/cúpula de vidro  
 Difusor: Opalino, Champagne ou Misto  
 (opalino interno e cristal externo)  
 Acabamento: Dourado fosco ou preto fosco

Canopla compatível com instalação em lajes  
 (caixa de passagem)

**\*A dimensão total do produto irá variar de acordo com a esfera utilizada**



## ● PDH1528PT

Pendente

5xG9 Halopin LED 5W  
 Dimensões: C1185 x L120 x A140 mm  
 Tensão: Bivolt (127V/220V)  
 Potência máxima: 25W  
 Cabo ajustável até 1500 mm

## ● PDH1528DO

Pendente

5xG9 Halopin LED 5W  
 Dimensões: C1185 x L120 x A140 mm  
 Tensão: Bivolt (127V/220V)  
 Potência máxima: 25W  
 Cabo ajustável até 1500 mm



**PDH1528PT**

\*5 esferas de 10cm

**PDH1528TRPT**

5 esferas de 12cm

**PDH1528CHPT**

5 esferas de 10cm



**PDH1528DO**

\*5 esferas de 10cm

**PDH1528TRDO**

5 esferas de 12cm

**PDH1528CHDO**

5 esferas de 10cm



PDH1528TRDO



# Orbit

Estrutura: Alumínio/cúpula de vidro  
 Difusor: Opalino, Champagne ou Misto  
 (opalino interno e cristal externo)  
 Acabamento: Dourado fosco ou preto fosco

.....  
 Ideal para instalação em paredes drywall



## ● ARH1535PT

Arandela

2xG9 Halopin LED 5W  
 Dimensões: C160 x L120 x A400 mm  
 Tensão: Bivolt (127V/220V)  
 Potência máxima: 10W

## ● ARH1535DO

Arandela

2xG9 Halopin LED 5W  
 Dimensões: C160 x L120 x A400 mm  
 Tensão: Bivolt (127V/220V)  
 Potência máxima: 10W



**ARH1535PT**  
 1 esfera de 10cm e  
 1 esfera de 12cm



**ARH1535TRPT**  
 1 esfera de 8cm e  
 1 esfera de 12cm



**ARH1535CHPT**  
 1 esfera de 10cm e  
 1 esfera de 12cm



**ARH1535DO**  
 1 esfera de 10cm e  
 1 esfera de 12cm



**ARH1535TRDO**  
 1 esfera de 8cm e  
 1 esfera de 12cm



**ARH1535CHDO**  
 1 esfera de 10cm e  
 1 esfera de 12cm



ARH1535PT

# Orbit

Estrutura: Alumínio/cúpula de vidro  
 Difusor: Opalino, Champagne ou Misto  
 (opalino interno e cristal externo)  
 Acabamento: Dourado fosco ou preto fosco

Canopla compacta exclusiva para forros de gesso



## ● PDH1530PT

Pendente

4xG9 Halopin LED 5W  
 Dimensões: C260 x L200 x A4750 mm  
 Tensão: Bivolt (127V/220V)  
 Potência máxima: 20W  
 Cabo ajustável até 1500 mm

## ● PDH1530DO

Pendente

4xG9 Halopin LED 5W  
 Dimensões: C260 x L200 x A4750 mm  
 Tensão: Bivolt (127V/220V)  
 Potência máxima: 20W  
 Cabo ajustável até 1500 mm



**PDH1530PT**  
 2 esferas de 8cm,  
 1 esfera de 10cm e  
 esfera de 12cm

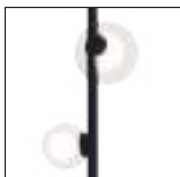

**PDH1530TRPT**  
 2 esferas de 8cm e  
 2 esferas de 12cm

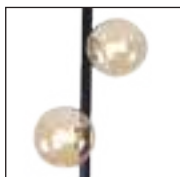

**PDH1530CHPT**  
 2 esferas de 10cm e  
 2 esferas de 12cm

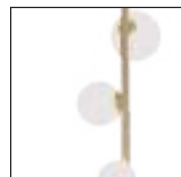

**PDH1530DO**  
 2 esferas de 8cm,  
 1 esfera de 10cm e  
 esfera de 12cm

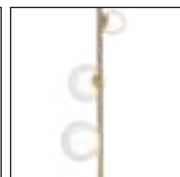

**PDH1530TRDO**  
 2 esferas de 8cm e  
 2 esferas de 12cm



**PDH1530CHDO**  
 2 esferas de 10cm e  
 2 esferas de 12cm



PDH1530TRPT

# Orbit

Estrutura: Alumínio/cúpula de vidro  
 Difusor: Opalino, Champagne ou Mistó  
 (opalino interno e cristal externo)  
 Acabamento: Dourado fosco ou preto  
 fosco

- Canopla para instalação em forros de gesso
- Compatível com tampa de caixa de passagem NAC00137 para instalação em lajes (vendida separadamente)

**\*A dimensão total do produto irá variar de acordo com a esfera utilizada**



PDH1532DO



## ● PDH1532PT

Pendente

1xG9 Halopin LED 5W  
 Dimensões: C180 x L100 x A280 mm  
 Tensão: Bivolt (127V/220V)  
 Potência máxima: 5W  
 Cabo ajustável até 1500 mm



## ● PDH1532CHDO

Pendente

1xG9 Halopin LED 5W  
 Dimensões: C180 x L100 x A280 mm  
 Tensão: Bivolt (127V/220V)  
 Potência máxima: 5W  
 Cabo ajustável até 1500 mm



**PDH1532PT**  
1 esfera de 10cm

**PDH1532TRPT**  
\*1 esfera de 12cm

**PDH1532CHPT**  
1 esfera de 10cm



**PDH1532DO**  
1 esfera de 10cm

**PDH1532TRDO**  
\*1 esfera de 12cm

**PDH1532CHDO**  
1 esfera de 10cm



● **PDH1533PT**

Pendente

2xG9 Halopin LED 5W  
 Dimensões: C260 x L120 x A260 mm  
 Tensão: Bivolt (127V/220V)  
 Potência máxima: 10W  
 Cabo ajustável até 1500 mm



PDH1533TRPT



● **PDH1533DO**

Pendente

2xG9 Halopin LED 5W  
 Dimensões: C260 x L120 x A260 mm  
 Tensão: Bivolt (127V/220V)  
 Potência máxima: 10W  
 Cabo ajustável até 1500 mm

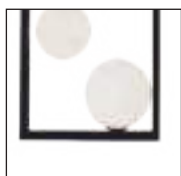

**PDH1533PT**  
 1 esfera de 10cm e  
 esfera de 12cm

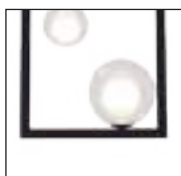

**PDH1533TRPT**  
 1 esfera de 8cm e  
 esfera de 12cm



**PDH1533CHPT**  
 1 esfera de 10cm e  
 esfera de 12cm



**PDH1533DO**  
 1 esfera de 10cm e  
 esfera de 12cm



**PDH1533TRDO**  
 1 esfera de 8cm e  
 esfera de 12cm

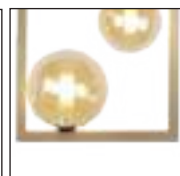

**PDH1533CHDO**  
 1 esfera de 10cm e  
 esfera de 12cm

# Orbit II

Estrutura: Alumínio/cúpula de vidro  
 Difusor: Opalino, Champagne ou Misto  
 (opalino interno e cristal externo)  
 Acabamento: Dourado fosco ou preto fosco

- Canopla para instalação em forros de gesso
- Compatível com tampa de caixa de passagem NAC00137 para instalação em lajes (vendida separadamente)

**\*A dimensão total do produto irá variar de acordo com a esfera utilizada**



## ● PDH1552TRPT

Pendente

1xG9 Halopin LED 5W  
 Dimensões: C100 x L100 x A250 mm  
 Tensão: Bivolt (127V/220V)  
 Potência máxima: 5W  
 Cabo ajustável até 1500 mm



## ● PDH1552DO

Pendente

1xG9 Halopin LED 5W  
 Dimensões: C100 x L100 x A250 mm  
 Tensão: Bivolt (127V/220V)  
 Potência máxima: 5W  
 Cabo ajustável até 1500 mm



**PDH1552PT**  
1 esfera de 10cm

**PDH1552TRPT**  
\*1 esfera de 12cm

**PDH1552CHPT**  
1 esfera de 10cm



**PDH1552DO**  
1 esfera de 10cm

**PDH1552TRDO**  
\*1 esfera de 12cm

**PDH1552CHDO**  
1 esfera de 10cm



PDH1552DO



# Orbit II

Estrutura: Alumínio/cúpula de vidro  
Difusor: Opalino, Champagne ou Misto  
(opalino interno e cristal externo)  
Acabamento: Dourado fosco ou preto  
fosco

- Canopla para instalação em forros de gesso
- Compatível com tampa de caixa de passagem NAC00137 para instalação em lajes (vendida separadamente)

\*A dimensão total do produto irá variar de acordo com a esfera utilizada



● **PDH1553CHDO**  
Pendente

2xG9 Halopin LED 5W  
Dimensões: C280 x L100 x A250 mm  
Tensão: Bivolt (127V/220V)  
Potência máxima: 10W  
Cabo ajustável até 1500 mm

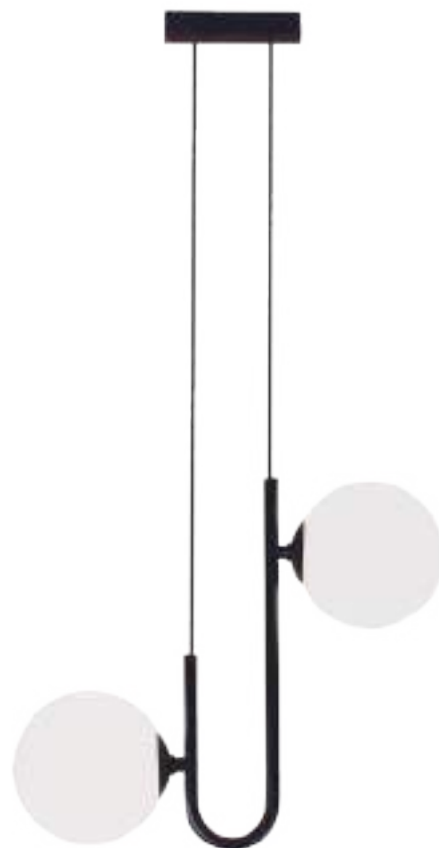

● **PDH1553PT**  
Pendente

2xG9 Halopin LED 5W  
Dimensões: C280 x L100 x A250 mm  
Tensão: Bivolt (127V/220V)  
Potência máxima: 10W  
Cabo ajustável até 1500 mm



PDH1553PT



**PDH1553PT**  
2 esferas de 10cm

**PDH1553TRPT**  
\*2 esferas de 12cm

**PDH1553CHPT**  
2 esferas de 10cm



**PDH1553DO**  
2 esferas de 10cm

**PDH1553TRDO**  
\*2 esferas de 12cm

**PDH1553CHDO**  
2 esferas de 10cm

# Orbit II

Estrutura: Alumínio/cúpula de vidro  
 Difusor: Opalino, Champagne ou Misto  
 (opalino interno e cristal externo)  
 Acabamento: Dourado fosco ou preto fosco

.....  
 Canopla compacta exclusiva para  
 forros de gesso



● **PDH1559PT**

Pendente

1xG9 Halopin LED 5W  
 Dimensões: C120 x L120 x A320 mm  
 Tensão: Bivolt (127V/220V)  
 Potência máxima: 5W  
 Cabo ajustável até 1500 mm

● **PDH1559DO**

Pendente

1xG9 Halopin LED 5W  
 Dimensões: C120 x L120 x A320 mm  
 Tensão: Bivolt (127V/220V)  
 Potência máxima: 5W  
 Cabo ajustável até 1500 mm



**PDH1559PT**  
1 esfera de 12cm

**PDH1559TRPT**  
1 esfera de 12cm

**PDH1559CHPT**  
1 esfera de 12cm



**PDH1559DO**  
1 esfera de 12cm

**PDH1559TRDO**  
1 esfera de 12cm

**PDH1559CHDO**  
1 esfera de 12cm



PDH1559PT

# Orbit II

Estrutura: Alumínio/cúpula de vidro  
 Difusor: Opalino, Champagne ou Misto  
 (opalino interno e cristal externo)  
 Acabamento: Dourado fosco ou preto  
 fosco

\*A dimensão total do produto irá variar de acordo com a esfera utilizada



ARH1536DO



● **ARH1536PT**  
Arandela

1xG9 Halopin LED 5W  
 Dimensões: C140 x L110 x A300 mm  
 Tensão: Bivolt (127V/220V)  
 Potência máxima: 5W



● **ARH1536DO**  
Arandela

1xG9 Halopin LED 5W  
 Dimensões: C140 x L110 x A300 mm  
 Tensão: Bivolt (127V/220V)  
 Potência máxima: 5W



**ARH1536PT**  
1 esfera de 10cm

**ARH1536TRPT**  
\*1 esfera de 12cm

**ARH1536CHPT**  
1 esfera de 10cm



**ARH1536DO**  
1 esfera de 10cm

**ARH1536TRDO**  
\*1 esfera de 12cm

**ARH1536CHDO**  
1 esfera de 10cm



Canopla compacta exclusiva para forros de gesso



● **PDH1539PT**

Pendente

4xG9 Halopin LED 5W  
 Dimensões: C900 x L100 x A230 mm  
 Tensão: Bivolt (127V/220V)  
 Potência máxima: 20W  
 Cabo ajustável até 1500 mm



PDH1539PT



● **PDH1539DO**

Pendente

4xG9 Halopin LED 5W  
 Dimensões: C900 x L100 x A230 mm  
 Tensão: Bivolt (127V/220V)  
 Potência máxima: 20W  
 Cabo ajustável até 1500 mm



**PDH1539PT**

\*2 esferas de 10cm e  
2 esferas de 12cm

**PDH1539TRPT**

2 esferas de 12cm

**PDH1539CHPT**

2 esferas de 10cm e  
2 esferas de 12cm



**PDH1539DO**

\*2 esferas de 10cm e  
2 esferas de 12cm

**PDH1539TRDO**

2 esferas de 12cm

**PDH1539CHDO**

2 esferas de 10cm e  
2 esferas de 12cm

# Orbit II

Estrutura: Alumínio/cúpula de vidro  
 Difusor: Opalino, Champagne ou Misto  
 (opalino interno e cristal externo)  
 Acabamento: Dourado fosco ou preto fosco

Canopla compacta exclusiva para forros de gesso

**\*A dimensão total do produto irá variar de acordo com a esfera utilizada**



## ● PDH1534PT

Pendente

1xG9 Halopin LED 5W  
 Dimensões: C100 x L100 x A235 mm  
 Tensão: Bivolt (127V/220V)  
 Potência máxima: 5W  
 Cabo ajustável até 1500 mm

## ● PDH1534CHDO

Pendente

1xG9 Halopin LED 5W  
 Dimensões: C100 x L100 x A235 mm  
 Tensão: Bivolt (127V/220V)  
 Potência máxima: 5W  
 Cabo ajustável até 1500 mm



**PDH1534PT**  
1 esfera de 10cm

**PDH1534TRPT**  
\*1 esfera de 12cm

**PDH1534CHPT**  
1 esfera de 10cm



**PDH1534DO**  
1 esfera de 10cm

**PDH1534TRDO**  
\*1 esfera de 12cm

**PDH1534CHDO**  
1 esfera de 10cm



PDH1534TRPT



# Hook

Estrutura: Alumínio/cúpula de vidro  
 Difusor: Opalino, Champagne ou Misto  
 (opalino interno e cristal externo)  
 Acabamento: Dourado ou preto fosco

**\*A dimensão total do produto irá variar de acordo com a esfera utilizada**



## ● ARH1560PT

Arandela

1xG9 Halopin LED 5W  
 Dimensões: C130 x L100 x A180 mm  
 Tensão: Bivolt (127V/220V)  
 Potência máxima: 5W  
 Cabo com 1500 mm com interruptor liga e desliga para ser ligado a tomada

## ● ARH1560DO

Arandela

1xG9 Halopin LED 5W  
 Dimensões: C130 x L100 x A180 mm  
 Tensão: Bivolt (127V/220V)  
 Potência máxima: 5W  
 Cabo com 1500 mm com interruptor liga e desliga para ser ligado a tomada



**ARH1560PT**

\*1 esfera de 10cm



**ARH1560TRPT**

1 esfera de 12cm



**ARH1560CHPT**

1 esfera de 10cm



**ARH1560DO**

\*1 esfera de 10cm



**ARH1560TRDO**

1 esfera de 12cm



**ARH1560CHDO**

1 esfera de 10cm



ARH1560PT

# Spy

Estrutura: Metal/vidro  
Difusor: Difusor branco opalino  
Acabamento: Preto ou dourado



● **AR1726DO**  
Arandela/Plafon

3x G9 5W  
Dimensões: C815 x L635 x P150 mm  
Tensão: Bivolt (127V/220V)  
Potência máxima: 15W



**AR1726DO**

**AR1726PT**

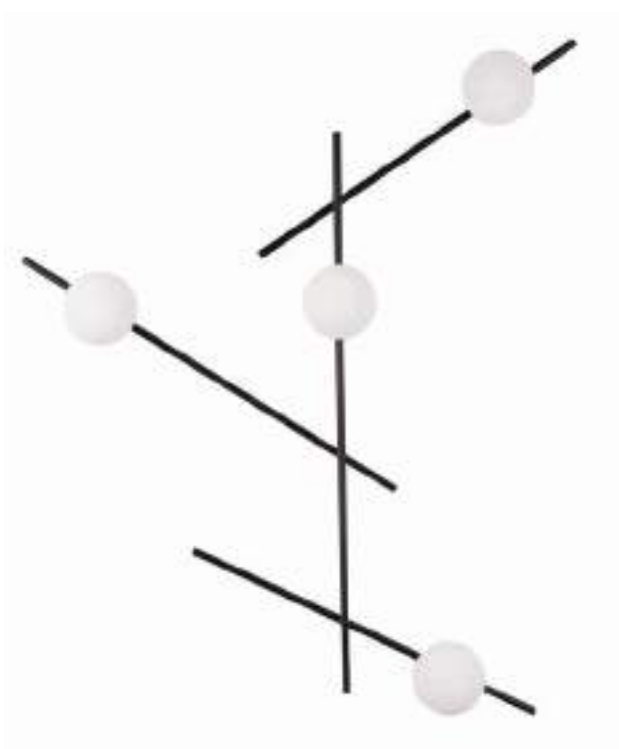

● **AR1727PT**  
Arandela/Plafon

4x G9 5W  
Dimensões: C920 x L780 x P150 mm  
Tensão: Bivolt (127V/220V)  
Potência máxima: 20W



**AR1727DO**

**AR1727PT**

Produto flexível na instalação



AR1727DO

# Orbit Mondri

Estrutura: Alumínio/cúpula de vidro  
 Difusor: Opalino, Champagne ou Misto  
 (opalino interno e cristal externo)  
 Acabamento: Dourado fosco ou preto fosco

Canopla de 10cm (recomendado para instalação em tetos/paredes de gesso)



## ● PLH1593PT

Plafon/Arandela

1x G9 Halopin LED 5W  
 Dimensões: C300 x L300 x A145 mm  
 Tensão: Bivolt (127V/220V)  
 Potência máxima: 5W



## ● PLH1593TRDO

Plafon/Arandela

1x G9 Halopin LED 5W  
 Dimensões: C300 x L300 x A145 mm  
 Tensão: Bivolt (127V/220V)  
 Potência máxima: 5W



**PLH1593PT**  
1 esfera de 12cm

**PLH1593TRPT**  
1 esfera de 12cm

**PLH1593CHPT**  
1 esfera de 12cm



**PLH1593DO**  
1 esfera de 12cm

**PLH1593TRDO**  
1 esfera de 12cm

**PLH1593CHDO**  
1 esfera de 12cm



PLH1594PT



● **PLH1594TRPT**

Plafon/Arandela

1x G9 Halopin LED 5W  
 Dimensões: C400 x L400 x A145 mm  
 Tensão: Bivolt (127V/220V)  
 Potência máxima: 5W



● **PLH1594CHDO**

Plafon/Arandela

1x G9 Halopin LED 5W  
 Dimensões: C400 x L400 x A145 mm  
 Tensão: Bivolt (127V/220V)  
 Potência máxima: 5W



**PLH1594PT**  
1 esfera de 12cm

**PLH1594TRPT**  
1 esfera de 12cm

**PLH1594CHPT**  
1 esfera de 12cm



**PLH1594DO**  
1 esfera de 12cm

**PLH1594TRDO**  
1 esfera de 12cm

**PLH1594CHDO**  
1 esfera de 12cm

# Orbit Mondri

Estrutura: Alumínio/cúpula de vidro  
 Difusor: Opalino, Champagne ou Misto  
 (opalino interno e cristal externo)  
 Acabamento: Dourado fosco ou preto  
 fosco

- Canopla de 10cm (recomendado para instalação em tetos/paredes de gesso)
- Pode ser utilizado como plafon ou arandela
- Necessária ligação elétrica em todas as bases
- Acompanha 1 canopla para montagem de produtos sobrepostos

\*A dimensão total da composição irá variar de acordo com a instalação

## KIT COM 2 PEÇAS PARA MONTAGEM MODULAR

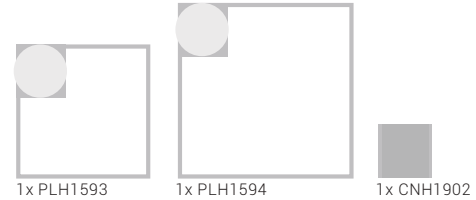

### ● PLH1595PT

Plafon/Arandela

2x G9 Halopin LED 5W  
 Dimensões: \* 1xPLH1593 C300 x L300 x A145 mm  
 + 1xPLH1594 C400 x L400 x A145 mm  
 Tensão: Bivolt (127V/220V)  
 Potência máxima: 10W



### ● PLH1595TRDO

Plafon/Arandela

2x G9 Halopin LED 5W  
 Dimensões: \* 1xPLH1593 C300 x L300 x A145 mm  
 + 1xPLH1594 C400 x L400 x A145mm  
 Tensão: Bivolt (127V/220V)  
 Potência máxima: 10W



**PLH1595PT**

2 esferas de 12cm

**PLH1595TRPT**

2 esferas de 12cm

**PLH1595CHPT**

2 esferas de 12cm



**PLH1595DO**

2 esferas de 12cm

**PLH1595TRDO**

2 esferas de 12cm

**PLH1595CHDO**

2 esferas de 12cm



PLH1595PT / PLH1595DO



# Orbit Mondri

Estrutura: Alumínio/cúpula de vidro  
 Difusor: Opalino, Champagne ou Misto  
 (opalino interno e cristal externo)  
 Acabamento: Dourado fosco ou preto fosco

- Canopla de 10cm (recomendado para instalação em tetos/paredes de gesso)
- Pode ser utilizado como plafon ou arandela



## ● PLH1596TRPT

Plafon/Arandela

1x G9 Halopin LED 5W  
 Dimensões: C500 x L120 x A145 mm  
 Tensão: Bivolt (127V/220V)  
 Potência máxima: 5W



## ● PLH1596CHDO

Plafon/Arandela

1x G9 Halopin LED 5W  
 Dimensões: C500 x L120 x A145 mm  
 Tensão: Bivolt (127V/220V)  
 Potência máxima: 5W



**PLH1596PT**  
1 esfera de 12cm

**PLH1596TRPT**  
1 esfera de 12cm

**PLH1596CHPT**  
1 esfera de 12cm



**PLH1596DO**  
1 esfera de 12cm

**PLH1596TRDO**  
1 esfera de 12cm

**PLH1596CHDO**  
1 esfera de 12cm



PLH1596PT



● **PLH1597CHPT**

Plafon/Arandela

1x G9 Halopin LED 5W  
 Dimensões: C600 x L120 x A145 mm  
 Tensão: Bivolt (127V/220V)  
 Potência máxima: 5W



● **PLH1597DO**

Plafon/Arandela

1x G9 Halopin LED 5W  
 Dimensões: C600 x L120 x A145 mm  
 Tensão: Bivolt (127V/220V)  
 Potência máxima: 5W



**PLH1597PT**  
1 esfera de 12cm

**PLH1597TRPT**  
1 esfera de 12cm

**PLH1597CHPT**  
1 esfera de 12cm



**PLH1597DO**  
1 esfera de 12cm

**PLH1597TRDO**  
1 esfera de 12cm

**PLH1597CHDO**  
1 esfera de 12cm

# Orbit Mondri

Estrutura: Alumínio/cúpula de vidro  
 Difusor: Opalino, Champagne ou Misto  
 (opalino interno e cristal externo)  
 Acabamento: Dourado fosco ou preto  
 fosco

- Canopla de 10cm (recomendado para instalação em tetos/paredes de gesso)
- Pode ser utilizado como plafon ou arandela
- Necessária ligação elétrica em todas as bases
- Acompanha 1 canopla para montagem de produtos sobrepostos

\*A dimensão total da composição irá variar de acordo com a instalação

## KIT COM 2 PEÇAS PARA MONTAGEM MODULAR

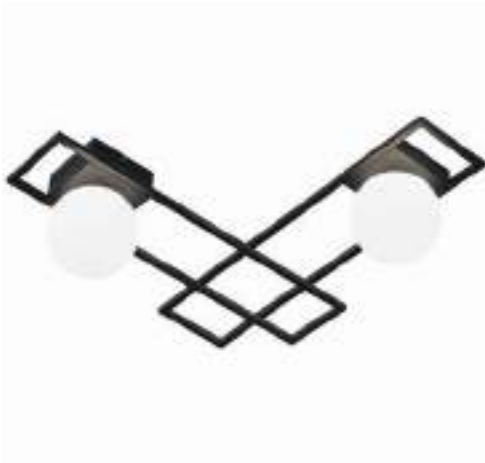
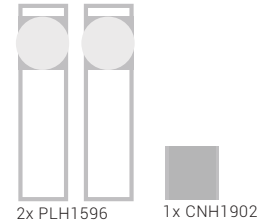

### ● PLH1598PT

Plafon/Arandela

2x G9 Halopin LED 5W  
 Dimensões: \* 2xPLH1596 C500 x L120 x A145 mm  
 Tensão: Bivolt (127V/220V)  
 Potência máxima: 10W



### ● PLH1598TRDO

Plafon/Arandela

2x G9 Halopin LED 5W  
 Dimensões: \* 2xPLH1596 C500 x L120 x A145 mm  
 Tensão: Bivolt (127V/220V)  
 Potência máxima: 10W



**PLH1598PT**  
2 esferas de 12cm

**PLH1598TRPT**  
2 esferas de 12cm

**PLH1598CHPT**  
2 esferas de 12cm



**PLH1598DO**  
2 esferas de 12cm

**PLH1598TRDO**  
2 esferas de 12cm

**PLH1598CHDO**  
2 esferas de 12cm



PLH1598PT

# Orbit Mondri

Estrutura: Alumínio/cúpula de vidro  
 Difusor: Opalino, Champagne ou Misto  
 (opalino interno e cristal externo)  
 Acabamento: Dourado fosco ou preto  
 fosco

- Canopla de 10cm (recomendado para instalação em tetos/paredes de gesso)
- Pode ser utilizado como plafon ou arandela
- Necessária ligação elétrica em todas as bases
- Acompanha 1 canopla para montagem de produtos sobrepostos

\*A dimensão total da composição irá variar de acordo com a instalação

## KIT COM 3 PEÇAS PARA MONTAGEM MODULAR

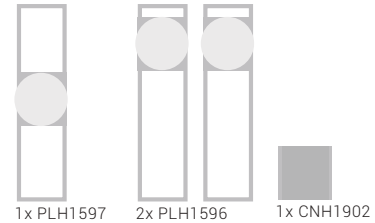

### ● PLH1905TRPT

Plafon/Arandela

3x G9 Halopin LED 5W  
 Dimensões: \* 2xPLH1596 C500 x L120 x A145 mm  
 + 1xPLH1597 C600 x L120 x A145 mm  
 Tensão: Bivolt (127V/220V)  
 Potência máxima: 15W



**PLH1905PT**  
3 esferas de 12cm

**PLH1905TRPT**  
3 esferas de 12cm

**PLH1905CHPT**  
3 esferas de 12cm



### ● PLH1905DO

Plafon/Arandela

3x G9 Halopin LED 5W  
 Dimensões: \* 2xPLH1596 C500 x L120 x A145 mm  
 + 1xPLH1597 C600 x L120 x A145 mm  
 Tensão: Bivolt (127V/220V)  
 Potência máxima: 15W



**PLH1905DO**  
3 esferas de 12cm

**PLH1905TRDO**  
3 esferas de 12cm

**PLH1905CHDO**  
3 esferas de 12cm

### CANOPLA PARA MONTAGEM DE CONJUNTOS

Necessário quando é realizada a montagem de composições de peças sobrepostas com utilização de produtos vendidos individualmente (item já incluso nos kits de montagens vendidos com duas ou mais peças)

- Produzido em alumínio
- Acabamentos dourado ou preto



### CNH1902PT

**Material:** Estrutura em alumínio

**Cor:** Preta

**Dimensões:** C10 x L10 x A3,8cm



### CNH1902DO

**Material:** Estrutura em alumínio

**Cor:** Dourada

**Dimensões:** C10 x L10 x A3,8cm

# Orbit Mondri

Estrutura: Alumínio/cúpula de vidro  
 Difusor: Opalino, Champagne ou Misto  
 (opalino interno e cristal externo)  
 Acabamento: Dourado fosco ou preto fosco

- Canopla de 10cm (recomendado para instalação em tetos/paredes de gesso)
- Pode ser utilizado como plafon ou arandela



## ● ARH1599PT

Plafon/Arandela

1x G9 Halopin LED 5W  
 Dimensões: C130 x L120 x A130 mm  
 Tensão: Bivolt (127V/220V)  
 Potência máxima: 5W

## ● ARH1599DO

Plafon/Arandela

1x G9 Halopin LED 5W  
 Dimensões: C130 x L120 x A130 mm  
 Tensão: Bivolt (127V/220V)  
 Potência máxima: 5W



**ARH1599PT**  
1 esfera de 12cm

**ARH1599TRPT**  
1 esfera de 12cm

**ARH1599CHPT**  
1 esfera de 12cm



**ARH1599DO**  
1 esfera de 12cm

**ARH1599TRDO**  
1 esfera de 12cm

**ARH1599CHDO**  
1 esfera de 12cm



ARH1599DO



# Cloud II

Estrutura: Metal / Vidro

Difusor: Difusor ambar / difusor interno  
branco opalino

Acabamento: Dourado



● **PD1682DO** *FORA DE LINHA*  
Pendente

1xG9 40W  
Dimensões: Ø300 x A315 mm  
Tensão: Bivolt (127V/220V)  
Potência máxima: 40W  
Cabo ajustável até 1500 mm

● **PD1683DO** *FORA DE LINHA*  
Pendente

1xG9 40W  
Dimensões: Ø450 x A435 mm  
Tensão: Bivolt (127V/220V)  
Potência máxima: 40W  
Cabo ajustável até 1500 mm

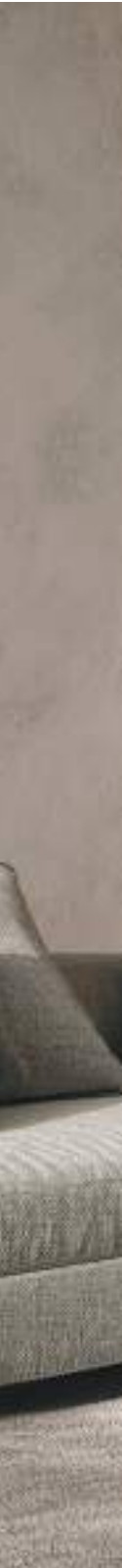



PD1682DO / PD1683DO

# Cloud

Estrutura: Metal e vidro  
 Difusor: Vidro opalino  
 Acabamento: Dourado ou preto  
 Cabo ajustável até 1,50 m

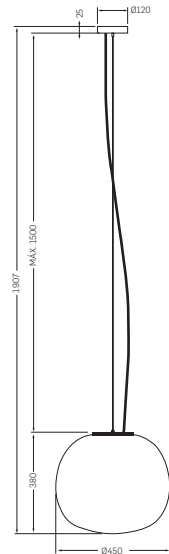

- PD1497DO
- PD1497PT

Pendente

1xE27 / 40W  
 Dim.: Ø450 x A380 mm  
 Tensão: Bivolt (127V/220V)  
 Potência máx.: 40W  
 Cabo ajustável até 1500 mm

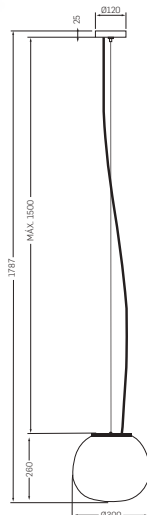

- PD1496DO
- PD1496PT

Pendente

1xE27 / 40W  
 Dimensões: Ø300 x A260 mm  
 Tensão: Bivolt (127V/220V)  
 Potência máx.: 40W  
 Cabo ajustável até 1500 mm



PD1497DO

# Full Moon

Estrutura: Metal / vidro / acrílico

Difusor: Acrílico

Acabamento: Dourado ou preto



● PD1639DO

● PD1639PT

Pendente

7W / 420lm / 3000K

Dim.: Ø350 x A350 mm

Tensão: Bivolt (127V/220V)

Cabo ajustável até 2000 mm





PD1639PT

# Ohana

Estrutura: Metal / Vidro

Difusor: Transparente ou champagne

Acabamento: Dourado ou Preto (onix)



● **PD1684DO**  
Pendente

LED 10W  
Lúmens: 700lm  
Temperatura: 3000K  
Dimensões: Ø300 x A320 mm  
Tensão: Bivolt (127V/220V)  
Potência máxima: 10W  
Cabo ajustável até 1500 mm



**PD1684DO**  
Cúpula Champagne



**PD16840X**  
Cúpula Transparente



PD16840X



# Plyn

Estrutura: Alumínio  
 Difusor: Acrílico branco  
 Acabamento: Dourado



● **AB1422**  
 Abajur

1xE27 / 40W  
 Potência máx.: 40W  
 Dimensões: Ø200 x A250 mm  
 Tensão: Bivolt (127V/220V)  
 Cabo com 1500 mm

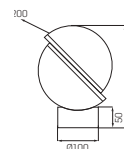

● **AR1421**  
 Arandela

Cabo dourado  
 1xG9 (LED) / 5W  
 Potência máx.: 5W  
 Dim.: Ø150 x C180 x A310 mm  
 Tensão: Bivolt (127V/220V)

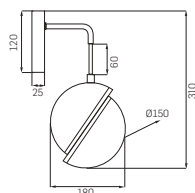



● **PD1420**  
Pendente

Cabo dourado  
1xE27 / 40W  
Potência máx.: 40W  
Dimensões: Ø200 x A240 mm  
Tensão: Bivolt (127V/220V)  
Cabo ajustável até 1500 mm

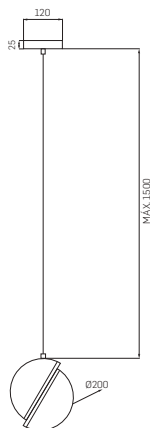

# Lolly

Estrutura: Metal/alumínio

Cúpula: Vidro branco

Acabamento: Bronze



PD1449

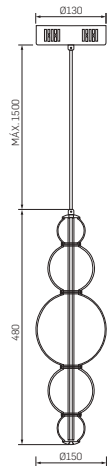

● **PD1448**  
Pendente

LED 15W / 1800lm / 3000K  
Potência máx.: 15W  
Dimensões: Ø150 x A480 mm  
Tensão: Bivolt (127V / 220V)  
Cabo ajustável até 1500 mm

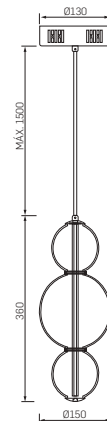

● **PD1449**  
Pendente

LED 11W / 1300lm / 3000K  
Potência máx.: 11W  
Dimensões: Ø150 x A360 mm  
Tensão: Bivolt (127V / 220V)  
Cabo ajustável até 1500 mm



● **AR1450**  
Arandela

LED 11W / 1300lm / 3000K  
Potência máx.: 11W  
Dim.: Ø150 x L210 x A430 mm  
Tensão: Bivolt (127V / 220V)

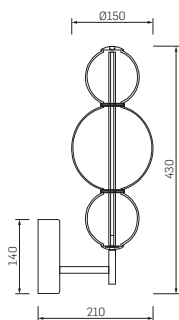

● **PD1451**  
Pendente

LED 11W / 1300lm / 3000K  
Potência máx.: 11W  
Dimensões: Ø100 x A400 mm  
Tensão: Bivolt (127V / 220V)  
Cabo ajustável até 1500 mm

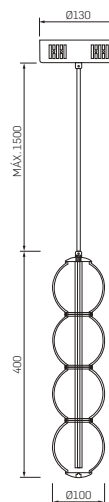

# Lolly

Estrutura: Metal/alumínio

Cúpula: Vidro branco

Acabamento: Bronze

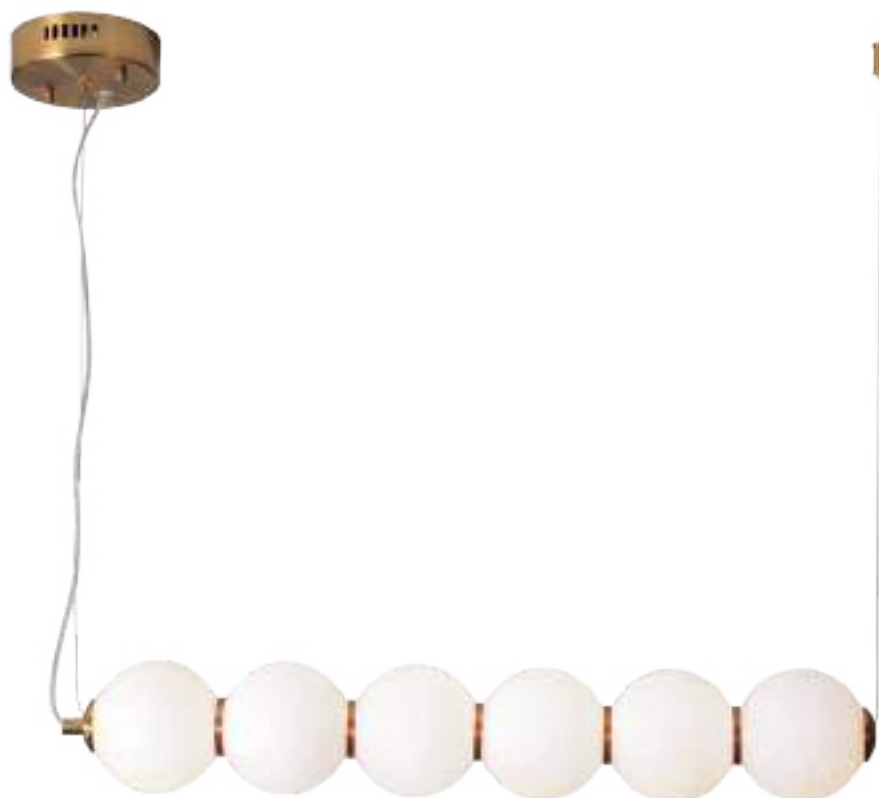

● **PD1452**  
Pendente

LED 19W / 2100lm / 3000K

Potência máx.: 19W

Dimensões: Ø100 x C600 x A1500 mm

Tensão: Bivolt (127V / 220V)

Cabo ajustável até 1500 mm

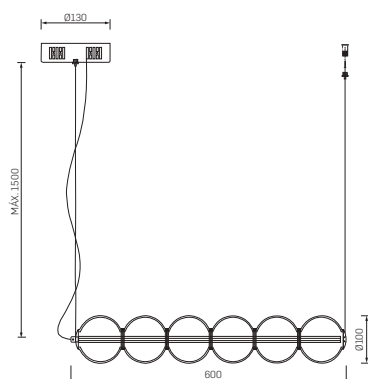



# Tera

Estrutura: Metal/ Acrílico  
 Difusor: Branco opalino  
 Acabamento: Preto ou Dourado



**FORA DE LINHA**



**FORA DE LINHA**

● **PD1757DO** **FORA DE LINHA**  
 Pendente

1xG9 LED 5W  
 Dimensões: Ø160 x A530 mm  
 Tensão: Bivolt (127V/220V)  
 Potência máxima: 5W  
 Cabo ajustável até 1500 mm

● **AB1758PT** **FORA DE LINHA**  
 Abajur

1xG9 LED 5W  
 Dimensões: Ø170 x A500 mm  
 Tensão: Bivolt (127V/220V)  
 Potência máxima: 5W  
 Possui cabo com 1500 mm com interruptor  
 liga e desliga para ser ligado a tomada



**PD1757PT**

**PD1757DO**



**AB1758PT**

**AB1758DO**

# Vermont

Estrutura: Metal/ Vidro  
Difusor: Cúpula branco opalino  
Acabamento: Dourado



● **PD1753**  
Pendente  
1xG9 LED 5W  
Dimensões: C222 x A180 mm  
Tensão: Bivolt (127V/220V)  
Potência máxima: 5W  
Cabo ajustável até 1500 mm



● **PD1752**  
Pendente  
2xG9 LED 5W  
Dimensões: C432 x A275 mm  
Tensão: Bivolt (127V/220V)  
Potência máxima: 10W  
Cabo ajustável até 1500 mm



● **PD1754**  
Pendente  
3xG9 LED 5W  
Dimensões: C1200 x A257 mm  
Tensão: Bivolt (127V/220V)  
Potência máxima: 15W  
Cabo ajustável até 1500 mm



# Lamu

Estrutura: Metal/ Acrílico / Poliestireno

Difusor: Branco

Acabamento: Branco



Luz indireta



PD1751

## ● PD1751

Pendente

LED 3x11w + 3W

Lúmens: 2520lm

Dimensões: C1000 x A1200 mm

Tensão: Bivolt (127V/220V)

Potência máxima: 36W

Cabo ajustável até 1500 mm



# Mini Moon

Estrutura: Metal/cúpula de acrílico

Difusor: Branco

Acabamento: Dourado ou Preto



● **PD1638PT**

Pendente

1xG9 Halopin LED 7W

Dimensões: ø120 x A250 mm

Tensão: Bivolt (127V/220V)

Potência máxima: 7W

Cabo ajustável até 2000 mm



**PD1638DO**

Acabamento  
dourado



**PD1638PT**

Acabamento preto



# Moon

Estrutura: Metal / Alumínio

Difusor: Acrílico

Acabamento: Dourado, Preto ou Branco

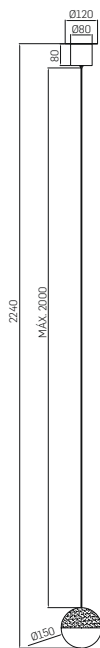

- PD1521D0
  - PD1521PT
  - PD1521BR
- Pendente D

7W / 420lm / 3000K  
 Dimensões: Ø150 x A2240 mm  
 Tensão: Bivolt (127V/220V)  
 Cabo ajustável até 2000 mm

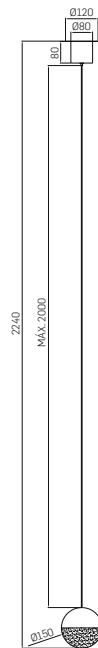

- PD1522D0
  - PD1522PT
  - PD1521BR
- Pendente U

7W / 420lm / 3000K  
 Dimensões: Ø150 x A2240 mm  
 Tensão: Bivolt (127V/220V)  
 Cabo ajustável até 2000 mm



PD1521PT / PD1522PT

# Moon

Estrutura: Metal  
 Difusor: Acrílico  
 Acabamento: Dourado ou preto



● PD1641DO

● PD1641PT

Pendente

14W (2x7W) / 840lm / 3000K  
 Dim.: C1120 x L150 x A375 mm  
 Tensão: Bivolt (127V/220V)  
 Cabo ajustável até 2000 mm

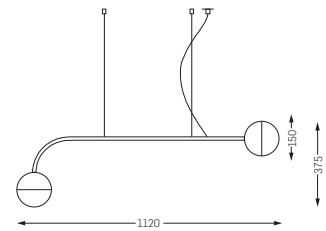

● AR1640DO

● AR1640PT

Arandela

7W / 420lm / 3000K  
 Dim.: C175 x L150 x A300 mm  
 Tensão: Bivolt (127V/220V)

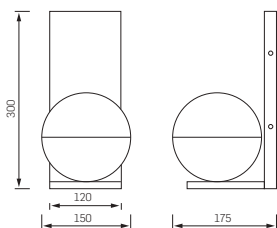



PD1641PT

# Moon

---

Estrutura: Metal

Difusor: Acrílico

Acabamento: Dourado ou preto



● **AB1720DO**

● **AB1720PT**

Abajur

LED 7W

Lúmens: 420lm

Temperatura: 3000K

Dimensões: Ø150 x A240 mm

Tensão: Bivolt (127V/220V)

Potência máxima: 7W

Cabo com 1500 mm



AB1720D0



# Triplet

Estrutura: Metal/cúpula de vidro

Difusor: Vidro champagne

Acabamento: Bronze



● **PD1081**

Pendente

LED: 5W

Lúmens: 360lm

Temperatura: 3000K

Dimensões: Ø310 xA150 mm

Tensão: Bivolt (127V/220V)

Potência máxima: 5W

Cabo ajustável até 1500 mm



● **PD1083**

Pendente

LED: 5W

Lúmens: 360lm

Temperatura: 3000K

Dimensões: Ø170 xA295 mm

Tensão: Bivolt (127V/220V)

Potência máxima: 5W

Cabo ajustável até 1500 mm



PD1081 / PD1083

# Kane

Estrutura: Metal/ Vidro/ Acrílico  
 Acabamento: Champagne ou fumê



**FORA DE LINHA**

**FORA DE LINHA**

● **PD1667DO** **FORA DE LINHA**  
 Pendente

LED 7W  
 Lúmens: 400lm  
 Temperatura: 3000K  
 Dimensões: Ø380 x A170 mm  
 Tensão: Bivolt (127V/220V)  
 Potência máxima: 7W  
 Cabo ajustável até 1500 mm

● **PD1668DO** **FORA DE LINHA**  
 Pendente

LED 7W  
 Lúmens: 400lm  
 Temperatura: 3000K  
 Dimensões: Ø260 x A240 mm  
 Tensão: Bivolt (127V/220V)  
 Potência máxima: 7W  
 Cabo ajustável até 1500 mm



**PD1667DO**      **PD1667OX**



**PD1668DO**      **PD1668OX**



● **AB1736DO**  
Abajur

LED 7W  
Lúmens: 400lm  
Temperatura: 3000K  
Dimensões: Ø220 x A520 mm  
Tensão: Bivolt (127V/220V)  
Potência máxima: 7W  
Possui cabo com 1500 mm com interruptor  
liga e desliga para ser ligado a tomada



**AB1736DO**



**AB1736OX**

# Cadre

Estrutura: Metal/cúpula de vidro  
Difusor: Cúpula champagne ou  
Cúpula branca  
Acabamento: Bronze ou Preto



● **PD1333PT**  
Pendente

1xG9 Halopin LED 5W  
Dimensões: C170 x L120 x A405 mm  
Tensão: Bivolt (127V/220V)  
Potência máxima: 5W  
Cabo ajustável até 1500 mm

● **PD1333BZ-BR**  
Pendente

1xG9 Halopin LED 5W  
Dimensões: C170 x L120 x A405 mm  
Tensão: Bivolt (127V/220V)  
Potência máxima: 5W  
Cabo ajustável até 1500 mm



**PD1333PT**  
Cúpula champagne

**PD1333BZ**  
Cúpula champagne



**PD1333PT-BR**  
Cúpula branca

**PD1333BZ-BR**  
Cúpula branca



● **PD1334PT**  
Pendente

2xG9 Halopin LED 5W  
Dimensões: C170 x L120 x A485 mm  
Tensão: Bivolt (127V/220V)  
Potência máxima: 10W  
Cabo ajustável até 1500 mm



**PD1334PT**  
Cúpula champagne



**PD1334BZ**  
Cúpula champagne



● **PD1334BZ-BR**  
Pendente

2xG9 Halopin LED 5W  
Dimensões: C170 x L120 x A485 mm  
Tensão: Bivolt (127V/220V)  
Potência máxima: 10W  
Cabo ajustável até 1500 mm



**PD1334PT-BR**  
Cúpula branca



**PD1334BZ-BR**  
Cúpula branca

# Cadre

Estrutura: Metal/cúpula de vidro

Difusor: Cúpula champagne ou

Cúpula branca

Acabamento: Bronze



PD1333BZ-BR



## ● PD1329BZ

Pendente

4xG9 Halopin LED 5W

Dimensões: C950 x L120 x A480 mm

Tensão: Bivolt (127V/220V)

Potência máxima: 20W

Cabo ajustável até 1500 mm



**PD1329BZ**  
Cúpula champagne



**PD1329BZ-BR**  
Cúpula branca

# Cadre

Estrutura: Metal/cúpula de vidro

Difusor: Cúpula champagne ou

Cúpula branca

Acabamento: Bronze ou Preto



AR1332PT



● **AR1332PT**

Arandela

1xG9 Halopin LED 5W

Dimensões: C200 x L120 x A390 mm

Tensão: Bivolt (127V/220V)

Potência máxima: 5W

● **AR1332BZ-BR**

Arandela

1xG9 Halopin LED 5W

Dimensões: C200 x L120 x A390 mm

Tensão: Bivolt (127V/220V)

Potência máxima: 5W



**AR1332PT**

Cúpula champagne

**AR1332BZ**

Cúpula champagne



**AR1332PT-BR**

Cúpula champagne

**AR1332BZ-BR**

Cúpula branca



# Deuce

Estrutura: Metal/cúpula de vidro  
Difusor: Cúpula Branca ou Champagne  
Acabamento: Dourado bronze



● **AR1346**

Arandela

2xG9 5W

Dimensões: C170 x L220 x A500 mm

Tensão: Bivolt (127V/220V)

Potência máxima: 10W



**AR1346**  
2 cúpulas  
champagne



**AR1346BR**  
2 cúpulas branca  
opalina



● **PD1347**

Pendente

2xG9 5W

Dimensões: C170 x L120 x A495 mm

Tensão: Bivolt (127V/220V)

Potência máxima: 10W

Cabo ajustável até 1500 mm



**PD1347**  
2 cúpulas  
champagne



**PD1347BR**  
2 cúpulas branca  
opalina



PD1347BR

# Cadre

Estrutura: Metal/cúpula de vidro

Difusor: Cúpula champagne ou

Cúpula branca

Acabamento: Bronze



AB1378BZ-BR

## ● AB1378BZ

Abajur

1xG9 Halopin LED 5W

Dimensões: C170 x L120 x A420 mm

Tensão: Bivolt (127V/220V)

Potência máxima: 5W

Cabo com 1500 mm com interruptor liga e desliga para ser ligado a tomada



**AB1378BZ**  
Cúpula champagne



**AB1378BZ-BR**  
Cúpula branca

# Bead

Estrutura: Metal/cúpula de vidro  
 Difusor: Cúpula champagne ou  
 Cúpula fumê  
 Acabamento: Preto ou Dourado



● **QAB1323FM**

Abajur

1xE27 40W (lâmpada LED de filamento)  
 Dimensões: Ø140 x A215 mm  
 Tensão: Bivolt (127V/220V)  
 Potência máxima: 40W  
 Possui cabo com 1500 mm com interruptor liga  
 e desliga para ser ligado a tomada



**QAB1323FM**



**QAB1323CH**



● **QPD1324CH**

Pendente

1xE27 40W (lâmpada LED de filamento)  
 Dimensões: Ø140 x A215 mm  
 Tensão: Bivolt (127V/220V)  
 Potência máxima: 40W  
 Cabo ajustável até 1500 mm



**QPD1324FM**



**QPD1324CH**

# Ravelo

Estrutura: Metal/cúpula de vidro

Difusor: Cúpula fumê ou Cúpula champagne

Acabamento: Preto ou Dourado



## ● PDH1581CH

Pendente

1xE27 40W

Dimensões: Ø150 x A300 mm

Tensão: Bivolt (127V/220V)

Potência máxima: 40W

Cabo ajustável até 1500 mm



## ● PDH1582CH

Pendente

5xE27 40W

Dimensões: C1185 x L150 x A250 mm

Tensão: Bivolt (127V/220V)

Potência máxima: 200W

Cabo ajustável até 1500 mm



**PDH1581FM**

1 esfera fumê



**PDH1581CH**

1 esfera champagne



**PDH1582FM**

5 esfera fumê



**PFH1582CH**

5 esfera champagne



PDH1581FM

# Torchia

Estrutura: Metal/cúpula de vidro

Difusor: Cúpula champagne

Acabamento: Dourada



● **AR1462**

Arandela

1xE27 40W

Dimensões: C353 x L150 x A203 mm

Tensão: Bivolt (127V/220V)

Potência máxima: 40W



● **PD1464**

Pendente

5xE27 40W

Dimensões: C1140 x L580 x A750 mm

Tensão: Bivolt (127V/220V)

Potência máxima: 200W

Haste ajustável até 700mm (400mm+300mm)



● **PD1465**

Pendente

7xE27 40W

Dimensões: C1300 x L700 x A750 mm

Tensão: Bivolt (127V/220V)

Potência máxima: 280W

Haste ajustável até 700mm (400mm+300mm)



PD1465



# Cutie

Estrutura: Metal/cúpula de vidro

Difusor: Cúpula champagne ou

Cúpula fumê

Acabamento: Cobre ou Preto



● **PD1330CH**

Pendente

4xE27 40W

Dimensões: C910 x L150 x A360 mm

Tensão: Bivolt (127V/220V)

Potência máxima: 160W

Cabo ajustável até 1500 mm

● **PD1331FM**

Pendente

6xE27 40W

Dimensões: 720 x A605 mm

Tensão: Bivolt (127V/220V)

Potência máxima: 240W

Cabo ajustável até 1500 mm



**PD1330CH**

4 cúpulas  
champagne

**PD1330FM**

4 cúpulas fumê



**PD1331CH**

6 cúpulas  
champagne

**PD1331FM**

6 cúpulas fumê



PD1330FM

# Eden

Estrutura: Metal/ Vidro

Cúpula: Cúpula Transparente /  
Champagne / Fumê

Acabamento: Preto ou Dourado



**FORA DE LINHA**

● **PD1755FM**

Pendente

1xG9 LED 5W

Dimensões: Ø150 x A215 mm

Tensão: Bivolt (127V/220V)

Potência máxima: 5W

Cabo ajustável até 1500 mm

**FORA DE LINHA**



**FORA DE LINHA**

PD1755CH



**PD1755TR**  
Vidro transparente



**PD1755CH**  
Vidro champagne



**PD1755FM**  
Vidro fumê

**FORA DE LINHA**

**FORA DE LINHA**

**FORA DE LINHA**

# Jetty

Estrutura: Metal/cúpula de vidro  
Difusor: Cúpula Cobre, Cúpula fumê  
ou Cúpula champagne  
Acabamento: Preto / Dourado



PD1492FM

● **PD1429CH**  
Pendente

1xE27 40W  
Dimensões: Ø150 xA210 mm  
Tensão: Bivolt (127V/220V)  
Potência máxima: 40W  
Cabo ajustável até 1500 mm



**PD1429CO**  
Cúpula cobre



**PD1429FM**  
Cúpula fumê



**PD1429CH**  
Cúpula champagne

# Drip

Estrutura: Metal/cúpula de vidro

Difusor: Cúpula champagne

Acabamento: Dourado



AR1382CH



● **AR1382CH**

Arandela

1xG9 5W

Dimensões: Ø120 xA230 mm

Tensão: Bivolt (127V/220V)

Potência máxima: 5W



● **PD1077-CH**

Pendente

1xG9 5W

Dimensões: Ø120 xA230 mm

Tensão: Bivolt (127V/220V)

Potência máxima: 5W

Cabo ajustável até 1500 mm

# Tear

Estrutura: Metal/cúpula de vidro com cristais

Difusor: Cúpula transparente com cristais transparentes

Acabamento: Cobre



● **AR1433**  
Arandela

1 xG9 (LED) 5W  
Dimensões: C120 xL130 x A300 mm  
Tensão: Bivolt (127V/220V)  
Potência máxima: 5W



● **PD1434**  
Pendente

1 xG9 (LED) 5W  
Dimensões: Ø90 xA 225 mm  
Tensão: Bivolt (127V/220V)  
Potência máxima: 5W  
Cabo ajustável até 1500 mm



# Clam

Estrutura: Metal/cúpula de vidro

Difusor: Vidro transparente ou

Vidro champagne

Acabamento: Cromado ou Champagne



● **PD622**

Pendente

1xGU10 50W

Dimensões: Ø120 x A600 mm

Tensão: Bivolt (127V/220V)

Potência máxima: 50W

Cabo ajustável até 1500 mm



● **AR1380DO**

Arandela

1xGU10 50W

Dimensões: Ø120 x A450 mm

Tensão: Bivolt (127V/220V)

Potência máxima: 50W



**PD622**

Vidro transparente



**PD622-D0**

Vidro champagne



**AR1380DO**

Vidro champagne



**AR1380CR**

Vidro transparente



PD622-DO



# Dublin

Estrutura: Metal/cúpula de vidro e pingentes de cristal

Difusor: Cúpula cromada ou

Cúpula cobre

Acabamento: Cromada ou Cobre



## ● QPD1279-CR

Pendente

1 xG9 40W

Dimensões: Ø130 x A150 mm

Tensão: Bivolt (127V/220V)

Potência máxima: 40W

Cabo ajustável até 1500 mm



## ● QAR1281-CO

Arandela

1 xG9 40W

Dimensões: Ø130 x C190 x A160 mm

Tensão: Bivolt (127V/220V)

Potência máxima: 40W



**QPD1279-CO**

Cúpula cobre

**QPD1279-CR**

Cúpula cromada



**QAR1281-CO**

Cúpula cobre

**QAR1281-CR**

Cúpula cromada

# Spring

Estrutura: Metal / cristais

Difusor: Cristais transparentes ou

Cristais ambar

Acabamento: Cobre ou Dourada



LT638



● **LT637**  
Lustre

1 xG9 5W  
Dimensões: Ø880 x A600 mm  
Tensão: Bivolt (127V/220V)  
Potência máxima: 5W  
Cabo ajustável até 1500 mm

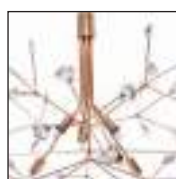

**LT637**  
Vidro transparente



**LT637-DO**  
Vidro ambar



● **LT638-DO**  
Lustre

1 xG9 5W  
Dimensões: Ø530 x A530 mm  
Tensão: Bivolt (127V/220V)  
Potência máxima: 5W  
Cabo ajustável até 1500 mm



**LT638**  
Vidro transparente



**LT638-DO**  
Vidro ambar

# Cálico

Estrutura: Metal/cúpula de vidro

Difusor: Cúpula cromada ou

Cúpula cobre

Acabamento: Preto



● **PD1290-CR**

Pendente

1xE27 40W

Dimensões: Ø250 xA250 mm

Tensão: Bivolt (127V/220V)

Potência máxima: 40W

Cabo ajustável até 1500 mm

● **PD1291-CO**

Pendente

1xE27 40W

Dimensões: Ø350 xA350 mm

Tensão: Bivolt (127V/220V)

Potência máxima: 40W

Cabo ajustável até 1500 mm



**PD1290-CR**

1 cúpula cromada

**PD1290-CO**

1 cúpula cobre



**PD1291-CR**

1 cúpula cromada

**PD1291-CO**

1 cúpula cobre



PD1290-CR

# Classic

Estrutura: Metal/cúpula de vidro

Difusor: Cúpula transparente

Acabamento: Cor madeira



● **606**  
Pendente

1xE27 40W  
Dimensões: Ø200 xA240 mm  
Tensão: Bivolt (127V/220V)  
Potência máxima: 40W  
Cabo ajustável até 1500 mm



● **609**  
Pendente

1xE27 40W  
Dimensões: Ø250 xA250 mm  
Tensão: Bivolt (127V/220V)  
Potência máxima: 40W  
Cabo ajustável até 1500 mm



● **617**  
Pendente

1xE27 40W  
Dimensões: Ø130 xA320 mm  
Tensão: Bivolt (127V/220V)  
Potência máxima: 40W  
Cabo ajustável até 1500 mm



609

# Hilton

Estrutura: Metal/cúpula de vidro  
 Difusor: Cúpula transparente  
 Acabamento: Preto ou Dourado



AR1719PT



## ● PD1432DO

Pendente

1xGU10 50W  
 Dimensões: Ø70 x A430 mm  
 Tensão: Bivolt (127V/220V)  
 Potência máxima: 50W  
 Cabo ajustável até 2000 mm

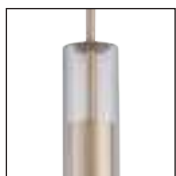

PD1432DO



PD1432PT



## ● AR1719PT

Arandela

1xGU10 50W  
 Dimensões: L70 x P120 x A170 mm  
 Tensão: Bivolt (127V/220V)  
 Potência máxima: 50W



AR1719DO



AR1719PT



LANÇAMENTO 2022



PD1432PT



# Pellet

Estrutura: Metal/cúpula de vidro  
 Difusor: Cúpula branca  
 Acabamento: Dourado ou Preto



● **PD1236**  
 Pendente

1xG9 5W  
 Dimensões: Ø120 xA105 mm  
 Tensão: Bivolt (127V/220V)  
 Potência máxima: 5W  
 Cabo ajustável até 1500 mm



● **PD1235**  
 Pendente

1xG9 5W  
 Dimensões: Ø120 xA130 mm  
 Tensão: Bivolt (127V/220V)  
 Potência máxima: 5W  
 Cabo ajustável até 1500 mm



● **PD1237**  
 Pendente

1xG9 5W  
 Dimensões: Ø150 xA95 mm  
 Tensão: Bivolt (127V/220V)  
 Potência máxima: 5W  
 Cabo ajustável até 1500 mm

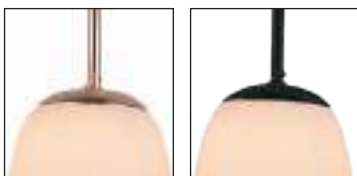

**PD1235**  
 Acabamento dourado

**PD1235PT**  
 Acabamento preto



**PD1236**  
 Acabamento dourado

**PD1236PT**  
 Acabamento preto



**PD1237**  
 Acabamento dourado

**PD1237PT**  
 Acabamento preto

# Spire

Estrutura: Metal/cúpula de vidro  
 Difusor: Cúpula champagne /  
 Cúpula fumê  
 Acabamento: Preto ou Dourado



QAB1325FM



## ● QAB1325CH

Abajur

1xE27 40W (lâmpada LED de filamento)  
 Dimensões: Ø90 xA300 mm  
 Tensão: Bivolt (127V/220V)  
 Potência máxima: 40W  
 Possui cabo com 1500 mm com interruptor liga e desliga para ser ligado a tomada



QAB1325CH



QAB1325FM



## ● QPD1348FM

Pendente

1xE27 40W (lâmpada LED de filamento)  
 Dimensões: Ø90 xA300 mm  
 Tensão: Bivolt (127V/220V)  
 Potência máxima: 40W  
 Cabo ajustável até 1500 mm



QPD1348CH



QPD1348FM

# Trento

Estrutura: Metal/cúpula de vidro  
 Difusor: Cúpula Branca / Fumê  
 ou Champagne  
 Acabamento: Dourado ou Preto



PDH1583BRPT

**FORA DE LINHA**



● **PDH1583BRPT** FORA DE LINHA  
 Pendente  
 1xG9 5W  
 Dimensões: Ø130 x A150 mm  
 Tensão: Bivolt (127V/220V)  
 Potência máxima: 5W  
 Cabo ajustável até 1500 mm

**FORA DE LINHA**



● **PDH1583BRDO** FORA DE LINHA  
 Pendente  
 1xG9 5W  
 Dimensões: Ø130 x A150 mm  
 Tensão: Bivolt (127V/220V)  
 Potência máxima: 5W  
 Cabo ajustável até 1500 mm

**FORA DE LINHA**



**PDH1583BRPT** PDH1583FMPT  
 1 esfera de 8cm branco opalino 1 esfera de 8cm branco opalino

**FORA DE LINHA**



**PDH1583BRDO** PDH1583ABDO  
 1 esfera de 8cm branco opalino 1 esfera de 8cm branco opalino



**FORA DE LINHA**

● **ARH1583BRPT**

Arandela

1xG9 5W

Dimensões: C200 x L130 x A250 mm

Tensão: Bivolt (127V/220V)

Potência máxima: 5W

**FORA DE LINHA**



**FORA DE LINHA**

● **ARH1583ABDO**

Arandela

1xG9 5W

Dimensões: C200 x L130 x A250 mm

Tensão: Bivolt (127V/220V)

Potência máxima: 5W

**FORA DE LINHA**



**ARH1583BRPT**

1 esfera de 8cm  
branco opalino

**ARH1583FMPT**

1 esfera de 8cm  
branco opalino

**FORA DE LINHA**



**ARH1583BRDO**

1 esfera de 8cm  
branco opalino

**ARH1583ABDO**

1 esfera de 8cm  
branco opalino

**FORA DE LINHA**

# Trento

Estrutura: Metal/cúpula de vidro  
 Difusor: Cúpula Branca / Fumê  
 ou Champagne  
 Acabamento: Dourado ou Preto



● **ABH1584FMPT**

Abajur

1xG9 5W

Dimensões: Ø130 x A400 mm

Tensão: Bivolt (127V/220V)

Potência máxima: 5W

Possui cabo com 1200 mm com interruptor liga e desliga para ser ligado a tomada

● **ABH1584BRDO**

Abajur

1xG9 5W

Dimensões: Ø130 x A400 mm

Tensão: Bivolt (127V/220V)

Potência máxima: 5W

Possui cabo com 1200 mm com interruptor liga e desliga para ser ligado a tomada



**ABH1584BRPT**  
 1 esfera de 8cm  
 branco opalino

**ABH1584FMPT**  
 1 esfera de 8cm  
 branco opalino



**ABH1584BRDO**  
 1 esfera de 8cm  
 branco opalino

**ABH1584ABDO**  
 1 esfera de 8cm  
 branco opalino



ABH1584ABDO

# Linse

Estrutura: Metal/ Vidro/ Lente  
Difusor: Vidro  
Acabamento: Preto ou Dourado



Canopla compacta exclusiva para forros de gesso

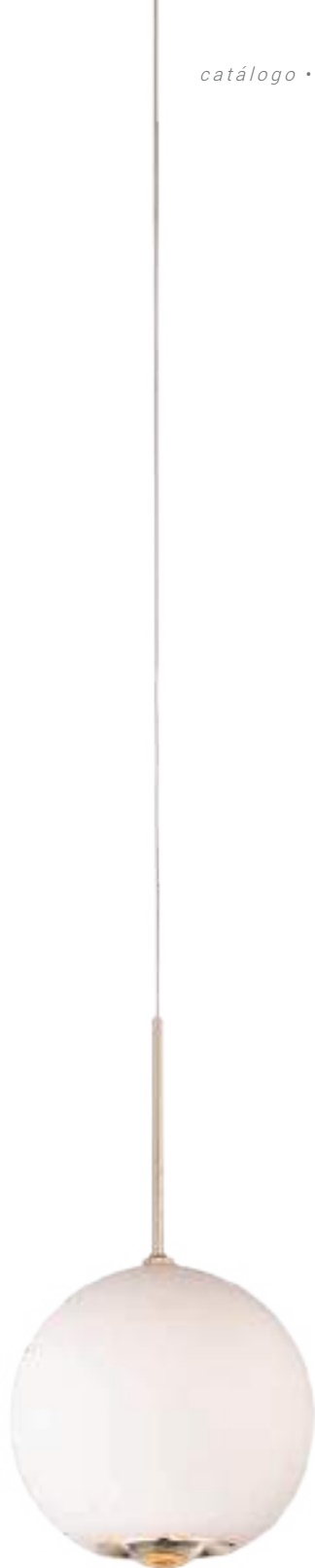

● **PD1714PT**  
Pendente

LED 8W  
Lúmens: 480lm  
Temperatura: 3000K  
Dimensões: Ø150 x L150 x A270 mm  
Tensão: Bivolt (127V/220V)  
Potência máxima: 8W  
Cabo ajustável até 2000 mm



**PD1714PT**



**PD1714DO**

# Augen

Estrutura: Metal/ Lente  
Acabamento: Preto (Onix) ou Dourado



Canopla compacta exclusiva para forros de gesso



PD1721DO

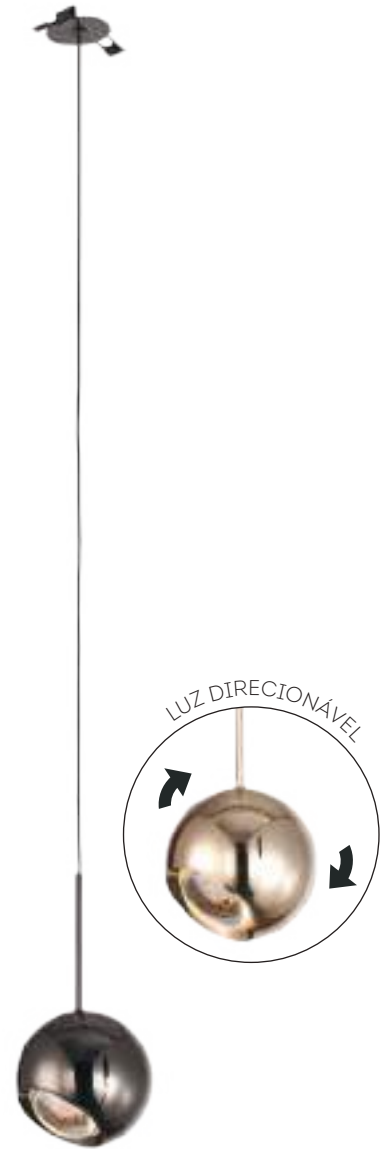

● **PD17210X**  
Pendente

LED 7W  
Lúmens: 420lm  
Potência: 3000K  
Dimensões: Ø120 x L120 x A240 mm  
Tensão: Bivolt (127V/220V)  
Potência máxima: 7W  
Cabo ajustável até 2000 mm



PD17210X



PD1721DO



# Vega

Estrutura: Metal

Acabamento: Branco, Marrom ou Preto  
com detalhe em Cobre ou Dourado.



QPD1163-PT



## ● QAR1483-PT

Arandela

1 x E27 | 40W

Dimensões: C279 x L206 x A202 mm

Tensão: Bivolt (127V/220V)

Potência máxima: 40W



### QAR1483-PT

Acabamento branco  
detalhe cobre



### QAR1483-PTDO

Acabamento preto  
detalhe dourado



## ● QPD1163-PTDO

Pendente

1 x E27 | 40W

Dimensões: Ø200 x A160 mm

Tensão: Bivolt (127V/220V)

Potência máxima: 40W

Cabo ajustável até 1500 mm



### QPD1163-BR

Acabamento branco  
detalhe cobre



### QPD1163-PT

Acabamento preto  
detalhe cobre



### QPD1163-PTDO

Acabamento preto  
detalhe dourado

# Dome

Estrutura: Metal/ Cúpula de tecido

Cúpula: Branca

Acabamento: Cromado ou Cobre



● **PD947-CR**

Pendente

1x E27 40W

Dimensões: Ø340 x A250 mm

Tensão: Bivolt (127V/220V)

Potência máxima: 40W

Haste 118 mm



**PD947-CR**

Acabamento cromado



**PD947-CO**

Acabamento cobre



# Drain

Estrutura: Alumínio

Cúpula: Tecido branco ou preto

Acabamento: Cromado ou preto



Hastes ajustáveis



● AR977

● AR977PT

Arandela

1xE27 / 40W

Potência máx.: 40W

Dim.: L370~870 x A270~570 mm

Cúpula Ø200 mm

Tensão: Bivolt (127V/220V)

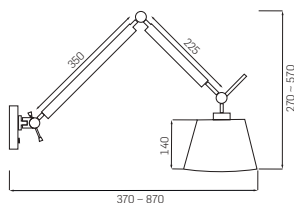



● AR978

● AR978PT

Arandela

1xE27 / 40W

Potência máx.: 40W

Dim.: L285 x A270 mm

Cúpula Ø200 mm

Tensão: Bivolt (127V/220V)

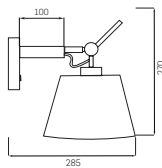

# Drain

Estrutura: Alumínio

Cúpula: Tecido branco ou preto

Acabamento: Cromado ou preto



Hastes ajustáveis



- PD976
  - PD976PT
- Pendente

1xE27 / 40W  
Potência máx.: 40W  
Dim.: C260~640 x A600~1400 mm  
Cúpula Ø260 mm  
Tensão: Bivolt (127V/220V)

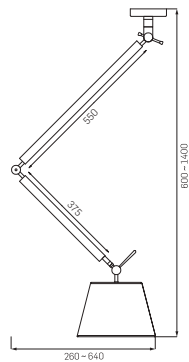



PD976

# Drain

---





PD976PT



# Drain Office

Estrutura: Alumínio e metal

Cúpula: Alumínio e metal

Acabamento: Prata/cromado ou preto



Hastes ajustáveis

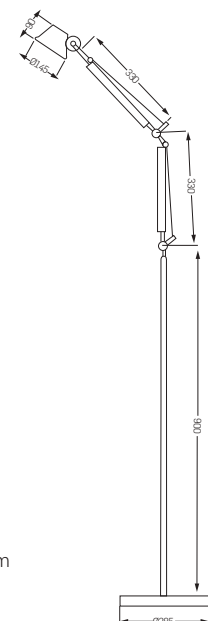

● **LM1603**

● **LM1603PT**

Luminária de mesa

1xE27 / 40W

Potência máx.: 40W

Dim.: C500 x L210 x A633 mm

Cúpula Ø145 mm

Tensão: Bivolt (127V/220V)

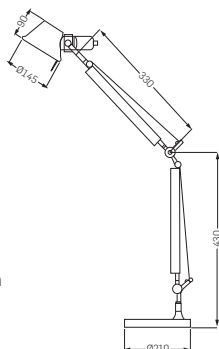

● **CL1604**

● **CL1604PT**

Coluna

1xE27 / 40W

Potência máx.: 40W

Dim.: C800 x L280 x A1650 mm

Cúpula Ø145 mm

Tensão: Bivolt (127V/220V)



- **AR1605**
- **AR1605PT**

Arandela

1xE27 / 40W  
 Potência máx.: 40W  
 Dim.: C260 x L115 x A230 mm  
 Cúpula Ø145 mm  
 Tensão: Bivolt (127V/220V)

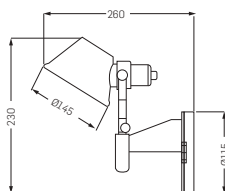

- **AR1606**
- **AR1606PT**

Arandela

1xE27 / 40W  
 Potência máx.: 40W  
 Dim.: C850 x L115 x A370 mm  
 Cúpula Ø145 mm  
 Tensão: Bivolt (127V/220V)

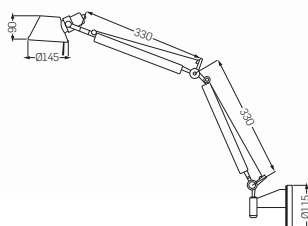



AR1606



LM1603PT

# Cozy

Estrutura: Metal/Cúpula de tecido

Cúpula: Branco

Acabamento: Branco, Preto  
ou Cromado



● **QAR1337CR**

Arandela

1 x E27 | 40W + LED 2W

Lúmens: 80lm

Temperatura: 3000K

Dimensões: C160 x L170 x A300 mm

Tensão: Bivolt (127V/220V)

Potência máxima: 16W

Cabo ajustável até 1500 mm



**QAR1337BR**  
Acabamento branco



**QAR1337CR**  
Acabamento cro-  
mado



**QAR1337PT**  
Acabamento preto

# Aniko

Estrutura: Alumínio  
Acabamento: Branco ou Preto



● **AR1428BR**

Arandela

1x E27 40W

Dimensões: C350 x L130 x A320 mm

Tensão: Bivolt (127V/220V)

Potência máxima: 40W

Possui cabo com 1500 mm com interruptor liga e desliga para ser ligado a tomada



**AR1428BR**  
Acabamento branco



**AR1428PT**  
Acabamento preto



AR1428PT

# Haus

Estrutura: Metal

Acabamento: Branco ou Preto

Entrada USB



AR1445BR



## ● AR1445PT

Arandela

1 x GU10 LED | 20W

Dimensões: C230 x L200 x A290 mm

Tensão: Bivolt (127V/220V)

Potência máxima: 20W



**AR1445BR**

Acabamento branco



**AR1445PT**

Acabamento preto

# Vision

Estrutura: Alumínio

Acabamento: Branco ou Prata ou Preto



AR1302-PT



● **AR1302-PR**  
Arandela

LED 3W  
Lúmens: 300lm  
Temperatura: 3000K  
Dimensões: L85 x A455 mm  
Tensão: Bivolt (127V/220V)  
Potência máxima: 3W



**AR1302-BR**

**AR1302-PR**

**AR1302-PT**

Acabamento branco Acabamento prata Acabamento preto



# Pipe

Estrutura: Alumínio

Acabamento: Branco ou Preto



AR1447PT



Interruptor liga/desliga

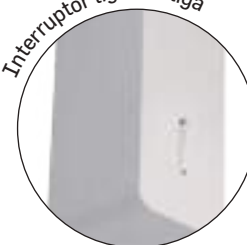

● **AR1447BR**

Arandela

LED 3W

Lúmens: 300lm

Temperatura: 3000K

Dimensões: C130 x L37 x A95 mm

Tensão: Bivolt (127V/220V)

Potência máxima: 3W



**AR1447BR**

Acabamento branco



**AR1447PT**

Acabamento preto

# Roof

Estrutura: Alumínio/Acrílico e aço inox

Difusor: Difusor branco

Acabamento: Cromada



AR803



● **AR803**  
Arandela

LED 8W

Lúmens: 321lm

Temperatura: 3000K

Dimensões: C452 x L45 x A125,8 mm

Tensão: Bivolt (127V/220V)

Potência máxima: 8W



● **AR804**  
Arandela

LED 12W

Lúmens: 554lm

Temperatura: 3000K

Dimensões: C595 x L45 x A125 mm

Tensão: Bivolt (127V/220V)

Potência máxima: 12W

# Askin

Estrutura: Metal

Acabamento: Branco, Marrom ou Preto  
com detalhes em cobre



● **QPD1161-PT**  
Pendente

1 x E27 | 40W  
Dimensões: Ø300 x A335 mm  
Tensão: Bivolt (127V/220V)  
Potência máxima: 40W  
Cabo ajustável até 1500 mm



**QPD1161-BR**  
Acabamento branco



**QPD1161-MR**  
Acabamento marrom  
detalhe cobre



**QPD1161-PT**  
Acabamento preto  
detalhe cobre



QPD1161-BR

# Beaver

Estrutura: Metal

Acabamento: Branco com detalhe em aço escovado/ Preto com detalhe em cobre



com interruptor  
liga/desliga

● **AR862-BR**  
Arandela

1 x E27 | 40W  
Dimensões: C165 x L530 x A700 mm  
Tensão: Bivolt (127V/220V)  
Potência máxima: 40W



● **LM860-PT**  
Luminária de mesa

1 x E27 | 40W  
Dimensões: C230 x L550 x A745 mm  
Tensão: Bivolt (127V/220V)  
Potência máxima: 40W  
Possui cabo com 1500 mm com interruptor  
liga e desliga para ser ligada a tomada



**AR862-BR**

Acabamento branco  
detalhe aço  
escovado

**AR862-MR**

Acabamento preto  
detalhe cobre



**LM860-BR**

Acabamento branco  
detalhe aço  
escovado

**LM860-PT**

Acabamento preto  
detalhe cobre



● **CL861-BR**

Coluna

1 x E27 | 40W

Dimensões: C250 x L1700 x A550 mm

Tensão: Bivolt (127V/220V)

Potência máxima: 40W

Possui cabo com 1500 mm com interruptor liga e desliga para ser ligado a tomada



**CL861-BR**

Acabamento branco  
detalhe aço escovado



**CL861-PT**

Acabamento preto  
detalhe cobre



CL861-PT

# Bergen

Estrutura: Metal

Acabamento: Preto com detalhe cromado



● **QCL1152-PT**

Coluna

1 x E27 | 40W

Dimensões: C340 x L205 x A1320 mm

Tensão: Bivolt (127V/220V)

Potência máxima: 40W

Possui cabo com 1800 mm com interruptor liga e desliga para ser ligado a tomada



QCL1152-PT

# Bergen

Estrutura: Metal

Acabamento: Branco com detalhe cromado / Preto com detalhe cobre



com interruptor  
liga/desliga

● **QAR1153-BR**  
Arandela

1 x E27 | 40W  
Dimensões: C225 x L120 x A170 mm  
Tensão: Bivolt (127V/220V)  
Potência máxima: 40W



● **QPD1158-PT**  
Pendente

1 x E27 | 40W  
Dimensões: Ø170 x A180 mm  
Tensão: Bivolt (127V/220V)  
Potência máxima: 40W  
Cabo ajustável até 1500 mm



**QAR1153-BR**  
Acabamento branco  
detalhe cromado



**QAR1153-PT**  
Acabamento preto  
detalhe cobre



**QPD1158-BR**  
Acabamento branco  
detalhe cromado



**QPD1158-PT**  
Acabamento preto  
detalhe cobre



# Brande

Estrutura: Metal

Acabamento: Branco com detalhes cromado / Preto com detalhes cobre



● **QLM1160-BR**

Luminária de mesa

1 x E27 | 40W

Dimensões: C390 x L150 x A520 mm

Tensão: Bivolt (127V/220V)

Potência máxima: 40W

Possui cabo com 1500 mm com interruptor liga e desliga para ser ligado a tomada



**QLM1160-BR**

Acabamento branco/  
detalhe cromado

**QLM1160-PT**

Acabamento preto/  
detalhe cobre



QLM1160-PT

# Nexus

Estrutura: Metal

Acabamento: Aço escovado ou Cobre



QAR1458AE



● **LM1060-CO**  
Luminária de mesa

1 x E27 | 40W  
Dimensões: Ø135 x A530 mm  
Tensão: Bivolt (127V/220V)  
Potência máxima: 40W  
Possui cabo com 1500 mm com interruptor liga e desliga para ser ligado a tomada

● **QAR1458AE**  
Arandela

1 x E27 | 40W  
Dimensões: L160 x C220 x A510 mm  
Tensão: Bivolt (127V/220V)  
Potência máxima: 40W



**LM1060-AE**  
Acabamento aço escovado



**LM1060-CO**  
Acabamento cobre



**QAR1458-AE**  
Acabamento aço escovado



**QAR1458-CO**  
Acabamento cobre

# Helmet

Estrutura: Metal

Acabamento: Branco com detalhes em aço escovado / Preto com detalhes em cobre

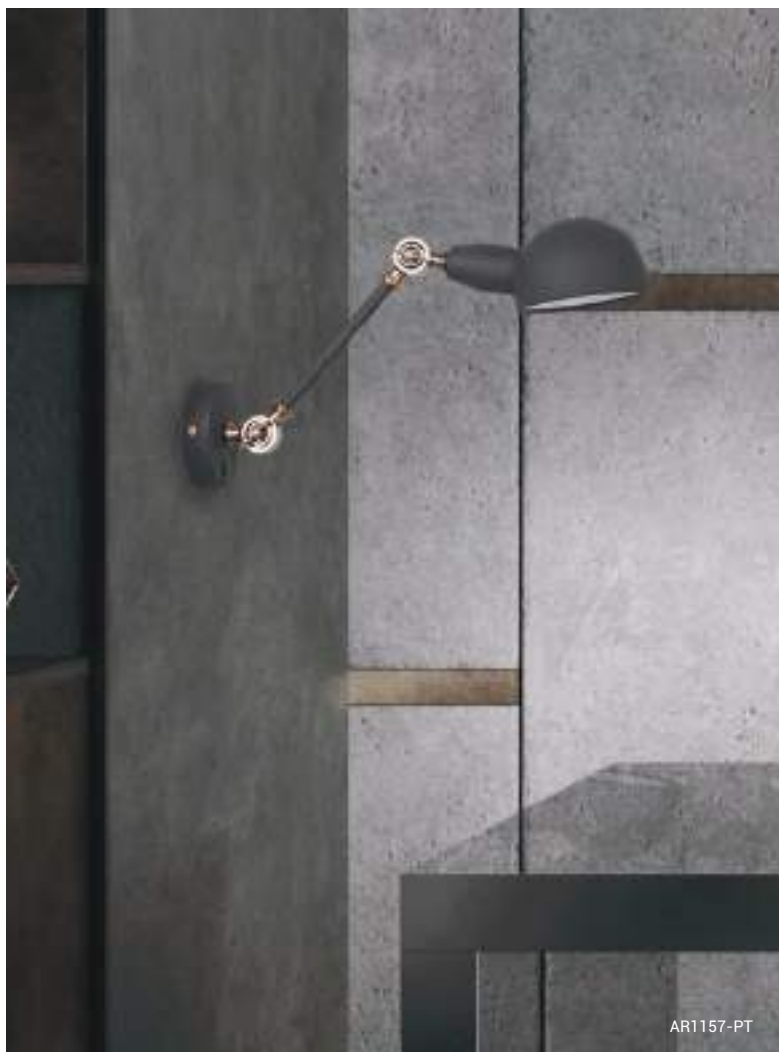

AR1157-PT

● **AR1157-BR**

Arandela

1 x E27 | 40W

Dimensões: C120 x L370 x A295 mm

Tensão: Bivolt (127V/220V)

Potência máxima: 40W



**AR1157-BR**

Acabamento branco/  
detalhe aço escovado

**AR1157-PT**

Acabamento preto/  
detalhe cobre



com interruptor  
liga/desliga

# Hamar

Estrutura: Metal

Acabamento: Branco ou Cinza com detalhe em cobre



com interruptor  
liga/desliga

● **QAR1154-BR**

Arandela

1 x E27 | 40W

Dimensões: C335 x L190 x A210 mm

Tensão: Bivolt (127V/220V)

Potência máxima: 40W



QAR1154-CZ



**QAR1154-BR**  
Acabamento branco  
detalhe cobre

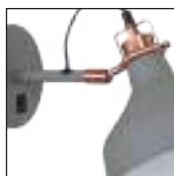

**QAR1154-CZ**  
Acabamento cinza  
detalhe cobre

# Horn

Estrutura: Metal/ Madeira

Madeira: Natural

Acabamento: Branco ou preto



● **QLM1064-BR**

Luminária de mesa

1 x G9 | 5W

Dimensões: L180 x A490 mm

Base: Ø140

Tensão: Bivolt (127V/220V)

Potência máxima: 5W

Possui cabo com 1500 mm com interruptor  
liga e desliga para ser ligado a tomada



**QLM1064-BR**  
Acabamento branco

**QLM1064-AE**  
Acabamento aço  
escovado

**QLM1064-CO**  
Acabamento cobre

**QLM1064-PT**  
Acabamento preto

# Horn

Estrutura: Metal/ Madeira

Madeira: Natural

Acabamento: Branco, Preto, Aço

Escovado ou Cobre



● **QPD1063-PT**

Pendente

1 x G9 | 5W

Dimensões: Ø125 x A190 mm

Tensão: Bivolt (127V/220V)

Potência máxima: 5W

Cabo ajustável até 1500 mm



**QPD1063-BR**  
Acabamento branco



**QPD1063-AE**  
Acabamento aço  
escovado

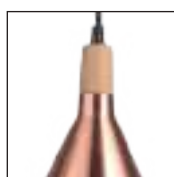

**QPD1063-CO**  
Acabamento cobre



**QPD1063-PT**  
Acabamento preto

# Horn

Estrutura: Metal/ Madeira  
 Madeira: Natural  
 Acabamento: Branco, Preto, Aço  
 Escovado ou Cobre



● **QAR1457AE**

Arandela

1 x G9 | 5W

Dimensões: L125 x C230 x A360 mm

Tensão: Bivolt (127V/220V)

Potência máxima: 5W

Possui cabo com 1500 mm com interruptor  
 liga e desliga para ser ligado a tomada



QAR1457PT



**QAR1457BR**  
 Acabamento branco



**QAR1457AE**  
 Acabamento aço  
 escovado



**QAR1457CO**  
 Acabamento cobre



**QAR1457PT**  
 Acabamento preto



# Horn

Estrutura: Metal/ Madeira  
Madeira: Natural  
Acabamento: Branco, Preto, Aço  
Escovado ou Cobre



● **QAR1466PT**

Arandela

1 x G9 | 5W

Dimensões: L125 x C180 x A190 mm

Tensão: Bivolt (127V/220V)

Potência máxima: 5W



**QAR1466BR**  
Acabamento branco



**QAR1466PT**  
Acabamento preto



# Horn

Estrutura: Metal/ Madeira  
Madeira: Natural  
Acabamento: Branco, Preto, Aço  
Escovado ou Cobre



● **QCL1467AE**  
Coluna

1 x G9 | 5W  
Dimensões: L230 x C240 x A1400 mm  
Tensão: Bivolt (127V/220V)  
Potência máxima: 5W  
Possui cabo com 1500 mm com interruptor  
liga e desliga para ser ligado a tomada



**QCL1467BR**  
Acabamento branco



**QCL1467AE**  
Acabamento aço  
escovado



**QCL1467CO**  
Acabamento cobre



**QCL1467PT**  
Acabamento preto



QAR1457PT

# Spine

Estrutura: Metal

Acabamento: Preto, Cobre ou Dourado



● **QPD1361DO**

Pendente

6 x E27 | 40W

Dimensões: C700 x L165 x A220 mm

Tensão: Bivolt (127V/220V)

Potência máxima: 240W

Cabo ajustável até 1500 mm

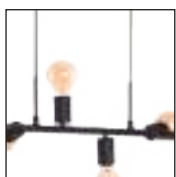

**QPD1361PT**  
Acabamento preto

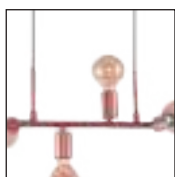

**QPD1361CO**  
Acabamento cobre

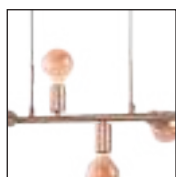

**QPD1361DO**  
Acabamento dourado



QPD1361CO

# Arrow

Estrutura: Metal

Acabamento: Preto ou Marrom



● **PD1310-CA**

Pendente

6x E27 40W

Dimensões: Ø500 x A510 mm

Tensão: Bivolt (127V/220V)

Potência máxima: 240W

Cabo ajustável até 1500 mm



**PD1310-CA**

Acabamento marrom/  
detalhe cobre



**PD1310-PT**

Acabamento preto/  
detalhe dourado



PD1310-CA

# Cluster

Estrutura: Metal

Acabamento: Preto ou Dourado



QPD13229DO



## ● QPD13224

Pendente

4 x E27 | 40W

Dimensões: Ø400 x A300 mm

Tensão: Bivolt (127V/220V)

Potência máxima: 160W

Cabo ajustável até 1500 mm



## ● QPD13229

Pendente

9 x E27 | 40W

Dimensões: Ø660 x A530 mm

Tensão: Bivolt (127V/220V)

Potência máxima: 360W

Cabo ajustável até 1500 mm



**QPD13224**

Acabamento preto



**QPD13224DO**

Acabamento dourado



**QPD13229**

Acabamento preto



**QPD13229DO**

Acabamento dourado

# Torch

Estrutura: Metal

Acabamento: Preto com detalhe em cobre ou preto com detalhe em dourado



● **QAR1349**

Arandela

1 x E27 | 40W

Dimensões: C110 x L110 x A195 mm

Tensão: Bivolt (127V/220V)

Potência máxima: 40W



**QAR1349**

Acabamento preto/  
detalhe cobre



**QAR1349DO**

Acabamento preto/  
detalhe dourado



QAR1349

# Trace

Estrutura: Metal

Acabamento: Preto com detalhes em cobre ou preto com detalhes em dourado



QAR1351



● **QAR1350**

Arandela

2 x E27 | 40W

Dimensões: C225 x L110 x A320 mm

Tensão: Bivolt (127V/220V)

Potência máxima: 80W



**QAR1350**

Acabamento preto/  
detalhe cobre

**QAR1350DO**

Acabamento preto/  
detalhe dourado



● **QAR1351**

Arandela

1 x E27 | 40W

Dimensões: C140 x L120 x A220 mm

Tensão: Bivolt (127V/220V)

Potência máxima: 40W



**QAR1351**

Acabamento preto/  
detalhe cobre

**QAR1351DO**

Acabamento preto/  
detalhe dourado



# Kiev

---

Estrutura: Metal

Acabamento: Preto com detalhes em cobre



● **QPL13154**

Plafon

4 x E27 | 40W

Dimensões: C320 x L210 x A140 mm

Tensão: Bivolt (127V/220V)

Potência máxima: 160W



● **QPD131412**

Pendente

12 x E27 | 40W

Dimensões: Ø430 x A310 mm

Tensão: Bivolt (127V/220V)

Potência máxima: 480W

Cabo ajustável até 1500 mm

● **QPD131418**

Pendente

18 x E27 | 40W

Dimensões: Ø545 x A515 mm

Tensão: Bivolt (127V/220V)

Potência máxima: 720W

Cabo ajustável até 1500 mm



QPD131412

# Globe

Estrutura: Metal

Acabamento: Preto com detalhe em cobre



● **PD1138**  
Pendente

1 x E27 | 40W  
Dimensões: Ø300 x A320 mm  
Tensão: Bivolt (127V/220V)  
Potência máxima: 40W  
Cabo ajustável até 1500 mm



PD1139



● **PD1139**  
Pendente

1 x E27 | 40W  
Dimensões: Ø400 x A420 mm  
Tensão: Bivolt (127V/220V)  
Potência máxima: 40W  
Cabo ajustável até 1500 mm



● **PD1140**  
Pendente

1 x E27 | 40W  
Dimensões: Ø500 x A520 mm  
Tensão: Bivolt (127V/220V)  
Potência máxima: 40W  
Cabo ajustável até 1500 mm

# Tine

Estrutura: Metal

Acabamento: Preto com detalhes em cobre



PD644



● **PD644**

Pendente

3 x E27 | 40W

Dimensões: C550 x L190 x A180 mm

Tensão: Bivolt (127V/220V)

Potência máxima: 120W

Cabo ajustável até 1500 mm



● **PD645**

Pendente

5 x E27 | 40W

Dimensões: C920 x L200 x A200 mm

Tensão: Bivolt (127V/220V)

Potência máxima: 200W

Cabo ajustável até 1500 mm

# Ivory

Estrutura: Metal

Acabamento: Preto com detalhes em cobre



● **PD642**  
Pendente

1 x E27 | 40W  
Dimensões: L200 x A200 mm  
Tensão: Bivolt (127V/220V)  
Potência máxima: 40W  
Cabo ajustável até 1500 mm



● **PD643**  
Pendente

6 x E27 | 40W  
Dimensões: L500 x A800 mm  
Tensão: Bivolt (127V/220V)  
Potência máxima: 240W  
Cabo ajustável até 1500 mm



PD643

# Nice

Estrutura: Metal

Acabamento: Preto ou Cobre



● **QPD919-CO**

Pendente

1 x E27 | 40W

Dimensões: Ø150 x A200 mm

Tensão: Bivolt (127V/220V)

Potência máxima: 40W

Cabo ajustável até 1500 mm



**QPD919-CO**

Acabamento preto/  
detalhe cobre



**QPD919-PT**

Acabamento preto/  
detalhe dourado



QPD919-PT

# Manner

Estrutura: Metal  
Acabamento: Preto

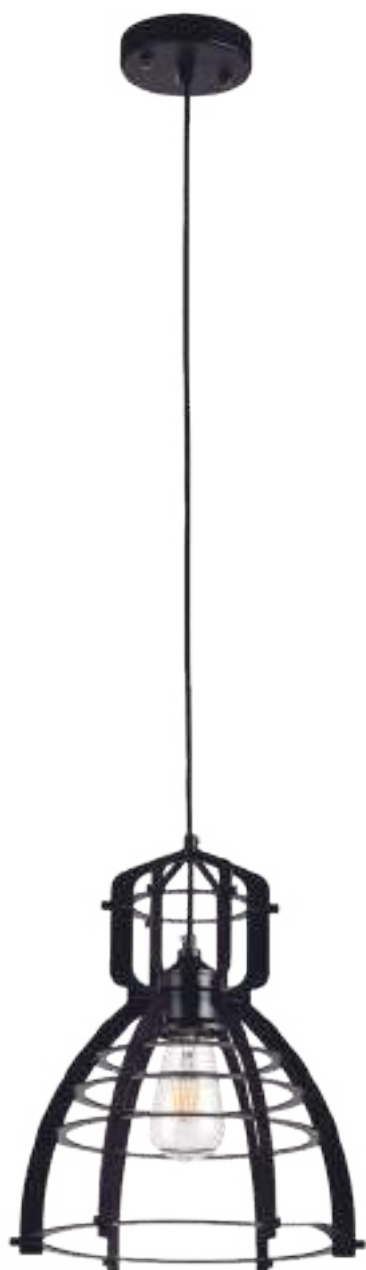

● **PD852**  
Pendente

1 x E27 | 40W  
Dimensões: Ø295 x A350 mm  
Tensão: Bivolt (127V/220V)  
Potência máxima: 40W  
Cabo ajustável até 1500 mm



# Lockup

Estrutura: Metal e Concreto

Acabamento: Preto



● **PD706**  
Pendente

1 x E27 | 40W  
Dimensões: Ø125 x A390 mm  
Tensão: Bivolt (127V/220V)  
Potência máxima: 40W  
Cabo ajustável até 1500 mm



● **PD707**  
Pendente

1 x E27 | 40W  
Dimensões: Ø260 x A300 mm  
Tensão: Bivolt (127V/220V)  
Potência máxima: 40W  
Cabo ajustável até 1500 mm



PD707

# Jubile

Estrutura: Metal e Concreto

Acabamento: Cobre



● **PD1127**  
Pendente

1 x E27 | 40W  
Dimensões: Ø180 x A195 mm  
Tensão: Bivolt (127V/220V)  
Potência máxima: 40W  
Cabo ajustável até 1500 mm



● **PD1128**  
Pendente

1 x E27 | 40W  
Dimensões: Ø300 x A220 mm  
Tensão: Bivolt (127V/220V)  
Potência máxima: 40W  
Cabo ajustável até 1500 mm



PD1128

# Sling

Estrutura: Concreto

Acabamento: Concreto



● **PD709**  
Pendente

1 x E27 | 40W  
Dimensões: Ø160 x A180 mm  
Tensão: Bivolt (127V/220V)  
Potência máxima: 40W  
Cabo ajustável até 1500 mm



PD709

# Somut

Estrutura: Metal/ Concreto

**PD1748:** Concreto / Vidro

**PD1756:** Metal/ Concreto/ Acrílico



● **PD1756**  
Pendente

1xG9 LED 5W  
Dimensões: Ø130 x A135 mm  
Tensão: Bivolt (127V/220V)  
Potência máxima: 5W  
Cabo ajustável até 2000 mm



● **PD1612**  
Pendente

LED 4W  
Lúmens: 300lm  
Temperatura: 3000K  
Dimensões: Ø45 x A400 mm  
Tensão: Bivolt (127V/220V)  
Potência máxima: 4W  
Cabo ajustável até 1500 mm



● **PD1748**

Pendente

1xG9 LED 5W  
Dimensões: Ø80 x A150 mm  
Tensão: Bivolt (127V/220V)  
Potência máxima: 5W  
Cabo ajustável até 1500 mm



● **PD1613**

Pendente

LED 4W  
Lúmens: 300lm  
Temperatura: 3000K  
Dimensões: Ø70 mm  
Tensão: Bivolt (127V/220V)  
Potência máxima: 4W  
Cabo ajustável até 1500 mm



PD1613

# Cover

Estrutura: Madeira ou Concreto  
Acabamento: Madeira ou Concreto  
Cabo: Preto



● **PD750**  
Pendente

1 x E27 | 40W  
Dimensões: Ø45 x A90 mm  
Tensão: Bivolt (127V/220V)  
Potência máxima: 40W  
Cabo ajustável até 1500 mm



● **PD751**  
Pendente

1 x E27 | 40W  
Dimensões: Ø45 x A90 mm  
Tensão: Bivolt (127V/220V)  
Potência máxima: 40W  
Cabo ajustável até 1500 mm

# Halter

Estrutura: Corda

Acabamento: Natural



● **PD712**  
Pendente

1 x E27 | 40W  
Dimensões: Ø35 x A1500 mm  
Tensão: Bivolt (127V/220V)  
Potência máxima: 40W  
Cabo ajustável até 1500 mm



# Post

---

Estrutura: Metal/ base de mármore/  
cúpula de tecido

Cúpula: Tecido preto

Acabamento: Preto



● **CL1024**

Coluna

1xE27 40W

Dimensões: C500 x L1630 x A1980 mm

Cúpula: Ø360 / Ø490 x A260 mm

Tensão: Bivolt (127V/220V)

Potência máxima: 40W

Possui cabo com 2200mm com interruptor liga e desliga para ser ligado a tomada



CL1024

# Krio

Estrutura: Alumínio  
Acabamento: Preto, Dourado ou Branco



AB1763BR

## ● AB1763PT

Abajur

2x G9 LED 5W

Dimensões: Ø250 x A365 mm

Tensão: Bivolt (127V/220V)

Potência máxima: 10W

Possui cabo com 1500 mm com interruptor liga e desliga para ser ligado a tomada



**AB1763BR**  
acabamento branco

**AB1763PT**  
acabamento preto

**AB1763DO**  
acabamento dourado

# Orla

Estrutura: Alumínio / Vidro  
Difusor: Branco opalino  
Acabamento: Preto, Dourado ou Branco



AB1762DO

## ● AB1762PT

Abajur

1x G9 5W

Dimensões: Ø150 x A405 mm

Tensão: Bivolt (127V/220V)

Potência máxima: 5W

Possui cabo com 1500 mm com interruptor liga e desliga para ser ligado a tomada



AB1762BR



AB1762PT



AB1762DO

# Mizo

Estrutura: Policarbonato  
Acabamento: Preto ou Branco

Acendimento e dimerização por touch,  
Acompanha cabo USB para recarregar,  
Direcionável



ACENDIMENTO  
TOUCH

## ● AB1766BR

Abajur

LED 4W

Voltagem: 5V

Lúmens: 400lm

Temperatura: 3000K / 4000k / 6000k Dimerizável

Dimensões: Ø140 x A218 mm

Tensão: USB-DC 5V

Potência máxima: 4W



**AB1766BR**  
acabamento branco



**AB1766PT**  
acabamento preto



**AB1766DO**  
acabamento dourado



Carregamento por USB

# Kono

Estrutura: Alumínio/Acrílico/ Silicone

Acabamento: Branco ou Cromada

Liga e Desliga ao toque (touch)

Acompanha cabo USB



● **AB1741CR**

Abajur

LED 2x 2,5W

Voltagem: 5V

Lúmens: 400lm

Temperatura: RGB Dimerizável

Dimensões: Ø150 C110 x L110 x A390 mm

Tensão: USB-DC 5V

Potência máxima: 5W

Recarregável por USB

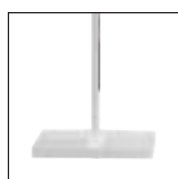

**AB1741BR**



**AB1741CR**

# Flint

Estrutura: Metal/cúpula de vidro

Difusor: Cúpula champagne /

Cúpula fumê

Acabamento: Preto ou Dourado



QAB1335CH



## ● QAB1335FM

Abajur

1xE27 40W (lâmpada LED de filamento)

Dimensões: Ø160 xA285 mm

Tensão: Bivolt (127V/220V)

Potência máxima: 40W

Possui cabo com 1500 mm com interruptor liga e desliga para ser ligado a tomada



## ● QAB1335CH

Abajur

1xE27 40W (lâmpada LED de filamento)

Dimensões: Ø160 xA285 mm

Tensão: Bivolt (127V/220V)

Potência máxima: 40W

Possui cabo com 1500 mm com interruptor liga e desliga para ser ligado a tomada

# Tint

Estrutura: Concreto  
 Cúpula (QAB1374): Tecido  
 Acabamento: Base cinza com detalhe em cobre ou Base preta com detalhe em dourado



QAB1374CO



## ● QAB1375CO

Abajur

1 x E27 | 40W  
 Dimensões: Ø90 x A120 mm  
 Tensão: Bivolt (127V/220V)  
 Potência máxima: 40W  
 Possui cabo com 1500 mm com interruptor liga e desliga para ser ligado a tomada



### QAB1375CO

Base cinza  
 Detalhe cobre

### QAB1375DO

Base preta  
 Detalhe dourado



## ● QAB1374DO

Abajur

1 x E27 | 40W  
 Dimensões: Ø180 x A371 mm  
 Tensão: Bivolt (127V/220V)  
 Potência máxima: 40W  
 Possui cabo com 1500 mm com interruptor liga e desliga para ser ligado a tomada



### QAB1374CO

Base cinza  
 detalhe cobre  
 cúpula branca

### QAB1374DO

Base preta  
 detalhe dourado  
 cúpula preta



# Potter

Estrutura: Cerâmica  
Cúpula: Branco ou Preto



● **QAB1454PT**

Abajur

1 x E27 | 40W

Dimensões: Ø150 x A320 mm

Tensão: Bivolt (127V/220V)

Potência máxima: 40W

Possui cabo com 1200 mm com interruptor liga e desliga para ser ligado a tomada



**QAR1454BR**

Acabamento branco



**QAR1454PT**

Acabamento preto





QAR1454BR

# Tack

Estrutura: Metal / Cúpula tecido

Cúpula: Branco / Preto

Acabamento: Dourado / Níquel / Preto



## ● QAB1066-DO

Abajur

1 x E27 | 40W

Dimensões: Ø160 x A290 mm

Tensão: Bivolt (127V/220V)

Potência máxima: 40W

Possui cabo com 1500 mm com interruptor liga e desliga para ser ligado a tomada



QAB1067-BR



## ● QAB1067-BR

Abajur

1 x E27 | 40W

Dimensões: Ø160 x A290 mm

Tensão: Bivolt (127V/220V)

Potência máxima: 40W

Possui cabo com 1500 mm com interruptor liga e desliga para ser ligado a tomada



## QAB1067-BR

Acabamento níquel /  
cúpula branca



## QAB1067-PT

Acabamento cobre /  
cúpula preto

# Turret

Estrutura: Metal / Cúpula de tecido

Cúpula: Branco ou Preto

Acabamento: Base dourada,

Base níquel ou Base cobre



QAB1069-BR



## ● QAB1068-DO

Abajur

1 x E27 | 40W

Dimensões: Ø200 x A365 mm

Tensão: Bivolt (127V/220V)

Potência máxima: 40W

Possui cabo com 1500 mm com interruptor liga e desliga para ser ligado a tomada



## ● QAB1069-BR

Abajur

1 x E27 | 40W

Dimensões: Ø200 x A365 mm

Tensão: Bivolt (127V/220V)

Potência máxima: 40W

Possui cabo com 1500 mm com interruptor liga e desliga para ser ligado a tomada



## QAB1069-BR

Acabamento níquel /  
cúpula branca



## QAB1069-PT

Acabamento cobre /  
cúpula preta

# Sicília

Estrutura: Cerâmica/ Cúpula tecido

Cúpula: Bege ou Preta

Acabamento: Bege ou Preta



## ● QAB914-PT

Abajur

1 x E27 | 40W

Dimensões: Ø150 x A300 mm

Tensão: Bivolt (127V/220V)

Potência máxima: 40W

Possui cabo com 1500 mm com interruptor liga e desliga para ser ligado a tomada



QAB914-PT



**QAB914-BG**  
Acabamento bege



**QAB914-PT**  
Acabamento preto

# Verona

Estrutura: Cerâmica / Cúpula de tecido

Cúpula: Bege ou Preto

Acabamento: Base bege ou Base preta



● **QAB916-BG**

Abajur

1 x E27 | 40W

Dimensões: Ø160 x A330 mm

Tensão: Bivolt (127V/220V)

Potência máxima: 40W

Possui cabo com 1500 mm com interruptor liga e desliga para ser ligado a tomada



**QAB916-BG**  
Acabamento bege



**QAB916-PT**  
Acabamento preto



QAB916-PT

# Bases de Abajur

CÚPULAS VENDIDAS SEPARADAMENTE



**CUP001BR**  
Cúpula

**BA001CR**  
Abajur

1x E27 40W  
Dimensões: 110 x A470 mm  
Acabamento: cromado  
Tensão: Bivolt (127V/220V)  
Potência máxima: 40W  
Cabo com 1500 mm



**CUP004PT**  
Cúpula

**BA001DO**  
Abajur

1x E27 40W  
Dimensões: 110 x A470 mm  
Acabamento: dourado  
Tensão: Bivolt (127V/220V)  
Potência máxima: 40W  
Cabo com 1500 mm



**CUP004BG**  
Cúpula



**CUP001BR**  
Cúpula

**BA002**

Abajur

1x E27 40W  
Dimensões: 160 x A500 mm  
Tensão: Bivolt (127V/220V)  
Potência máxima: 40W  
Cabo com 1500 mm



**CUP001BG**  
Cúpula

**BA010**

Abajur

1x E27 40W  
Dimensões: 120 x A480 mm  
Tensão: Bivolt (127V/220V)  
Potência máxima: 40W  
Cabo com 1500 mm



# Bases de Abajur

CÚPULAS VENDIDAS SEPARADAMENTE



**CUP004BR**  
Cúpula



**CUP003FD**  
Cúpula

## **BA003**

Abajur

1x E27 40W

Dimensões: 120 x L120 x A420 mm

Acabamento: Mármore preto

Tensão: Bivolt (127V/220V)

Potência máxima: 40W

Cabo com 1500 mm



**CUP003BG**  
Cúpula



BA004 / CUP003BG

**BA004**

Abajur

1x E27 40W  
Dimensões: 220 x L120 x A440 mm  
Acabamento: Mármore preto  
Tensão: Bivolt (127V/220V)  
Potência máxima: 40W  
Cabo com 1500 mm



**CUP004PT**  
Cúpula

# Bases de Abajur

CÚPULAS VENDIDAS SEPARADAMENTE



**CUP002FD**  
Cúpula



**CUP003BG**  
Cúpula

## **BA005**

Abajur

1x E27 40W

Dimensões: 280 x L120 x A320 mm

Tensão: Bivolt (127V/220V)

Potência máxima: 40W

Cabo com 1500 mm



**CUP002BG**  
Cúpula



**BA006**

Abajur

1x E27 40W

Dimensões: 150 x L150 x A550 mm

Tensão: Bivolt (127V/220V)

Potência máxima: 40W

Cabo com 1500 mm



**CUP004FD**  
Cúpula



# Bases de Abajur

CÚPULAS VENDIDAS SEPARADAMENTE



**CUP001FD**  
Cúpula

## **BA007**

Abajur

1x E27 40W  
Dimensões: 280 x L120 x A320 mm  
Tensão: Bivolt (127V/220V)  
Potência máxima: 40W  
Cabo com 1500 mm



**CUP002PT**  
Cúpula



**CUP004FD**  
Cúpula



**CUP001BG**  
Cúpula

**BA008**

Abajur

1x E27 40W

Dimensões: 120 x A520 mm

Tensão: Bivolt (127V/220V)

Potência máxima: 40W

Cabo com 1500 mm

# Bases de Abajur

CÚPULAS VENDIDAS SEPARADAMENTE



**CUP002PT**  
Cúpula



**CUP003FD**  
Cúpula

## **BA009**

Abajur

1x E27 40W

Dimensões: 120 x L100 x A470 mm

Tensão: Bivolt (127V/220V)

Potência máxima: 40W

Cabo com 1500 mm



**BA011**  
Abajur

**BA011**  
Abajur

1x E27 40W  
Dimensões: 250 x L100 x A460 mm  
Tensão: Bivolt (127V/220V)  
Potência máxima: 40W  
Cabo com 1500 mm



**CUP003PT**  
Cúpula



# Bases de Abajur

CÚPULAS VENDIDAS SEPARADAMENTE



**CUP001PT**  
Cúpula

**BA012**  
Abajur

1x E27 40W  
Dimensões: 180 x L130 x A527 mm  
Material: Cristal  
Tensão: Bivolt (127V/220V)  
Potência máxima: 40W  
Cabo com 1500 mm



**CUP004BR**  
Cúpula



**CUP003BG**  
Cúpula



**CUP004PT**  
Cúpula

**BA013**  
Abajur

1x E27 40W  
Dimensões: 180 x L130 x A527 mm  
Material: Cristal  
Tensão: Bivolt (127V/220V)  
Potência máxima: 40W  
Cabo com 1500 mm

# Bases de Abajur

CÚPULAS VENDIDAS SEPARADAMENTE



**CUP002BR**  
Cúpula



**CUP001PT**  
Cúpula

**BA015**  
Abajur

1x E27 40W  
Dimensões: 100 x A395 mm  
Material: Cristal  
Tensão: Bivolt (127V/220V)  
Potência máxima: 40W  
Cabo com 1500 mm



**CUP001FD**  
Cúpula

**BA016**  
Abajur

1x E27 40W  
Dimensões: 140 x A430 mm  
Material: Cristal  
Tensão: Bivolt (127V/220V)  
Potência máxima: 40W  
Cabo com 1500 mm



**CUP003PT**  
Cúpula

# Bases de Abajur

CÚPULAS VENDIDAS SEPARADAMENTE



**CUP001FD**  
Cúpula

## **BA017**

Abajur

1x E27 40W  
Dimensões: 120 x A424 mm  
Material: Cristal  
Tensão: Bivolt (127V/220V)  
Potência máxima: 40W  
Cabo com 1500 mm



**CUP002PT**  
Cúpula



BA017 / CUP002PT

# Cúpulas de Abajur



## CUP001

Cúpula Cilíndrica

Material: Tecido

Dimensões: 400 x 400 x 300 mm



CUP001BR

CUP001PT

CUP001BG

CUP001FD



## CUP002

Cúpula Cilíndrica

Material: Tecido

Dimensões: 300 x 300 x 330 mm



CUP002BR

CUP002PT

CUP002BG

CUP002FD



**CUP003**  
Cúpula Retangular

Material: Tecido  
Dimensões: 400 x 230 x 300 mm



**CUP004**  
Cúpula Cônica

Material: Tecido  
Dimensões: 420 x 340 x 310 mm





# ENDLESS POSSIBILITIES

# Modular **Magnetic** System

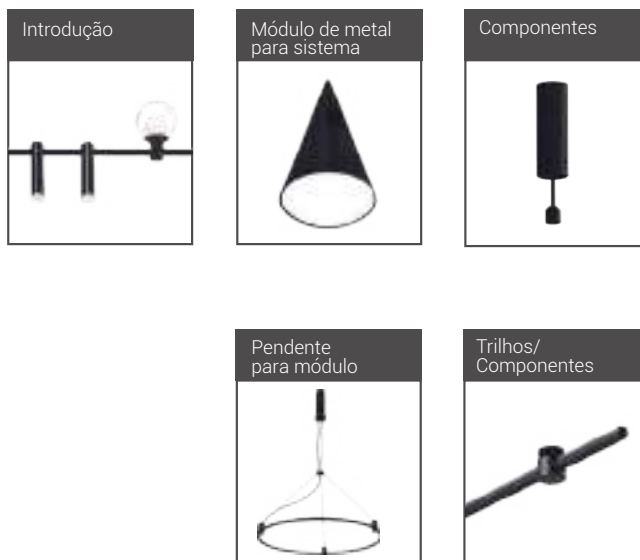

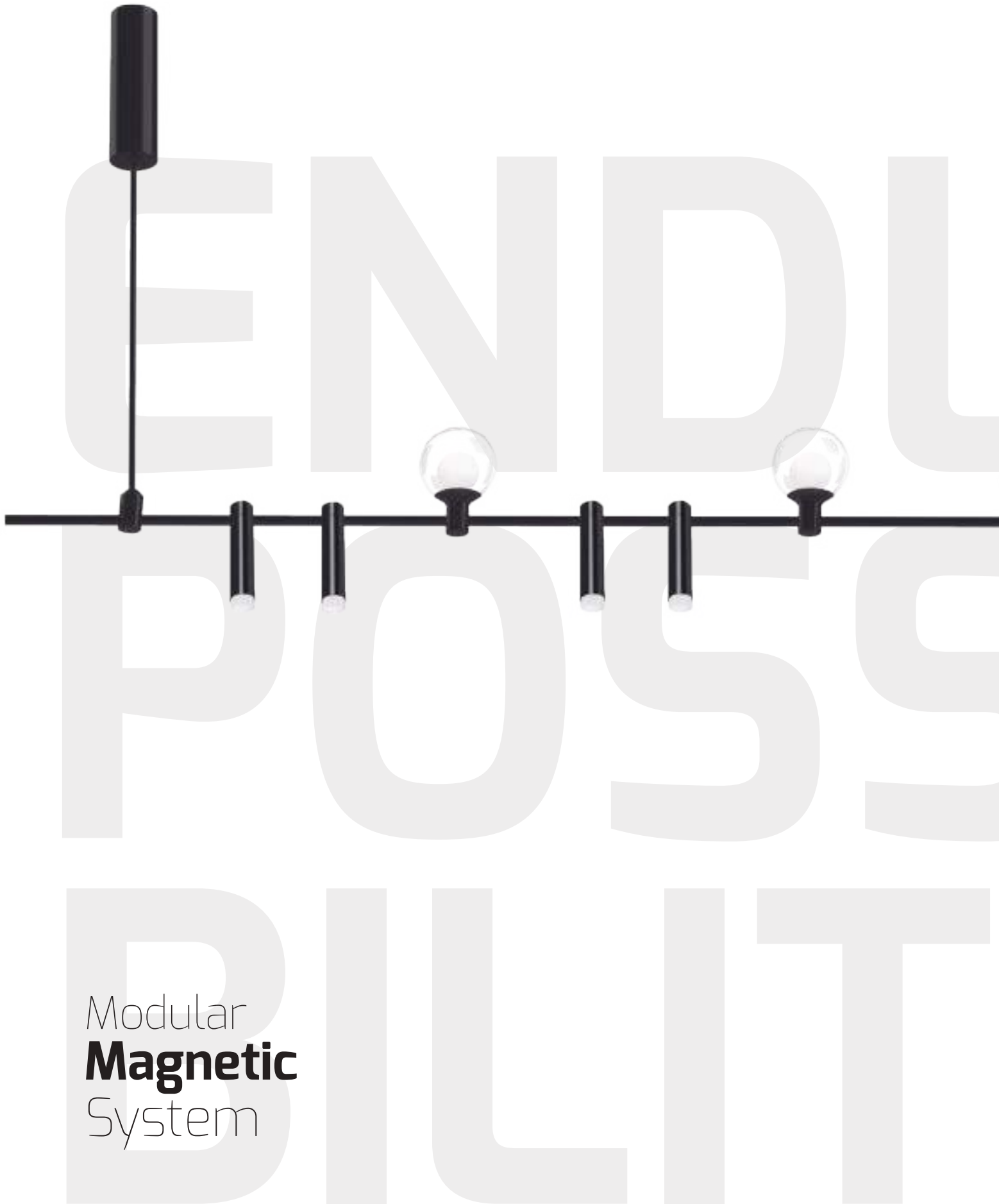

Modular  
**Magnetic**  
System



O sistema magnético modular Studioluce apresenta uma nova maneira de iluminar: Moderna e prática, munida com o melhor da tecnologia. Liberdade de escolha, desde o tamanho e altura do trilho até os módulos de luminárias, que podem ser combinados para a melhor composição de design e resultado luminotécnico. Escolha. Combine. Ilumine!



Design inovador  
Variedade de acessórios e módulos  
Possibilidade de montagens diversificadas



Fácil  
instalação  
com  
**fixação  
magnética**

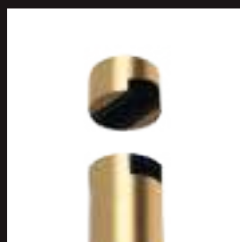

## Modular **Magnetic** System



Bivolt 100-240V

Sistema 24V

Potência máxima 100W

Não possui fios

Fixação magnética

Crie seu próprio design

Fontes luminosas, podem ser posicionadas em qualquer parte do trilho, para cima ou para baixo



<b>SST1383</b>	
Dim. (mm)	Ø60 x A107
Potência	5W
Tem. Cor	3000K
Voltagem	24V
Fluxo (lm)	200 lm
IRC	>90
Material	Alumínio + Acrílico
Acabamento	Dourado / Preto
Garantia	3 anos

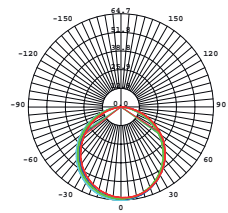
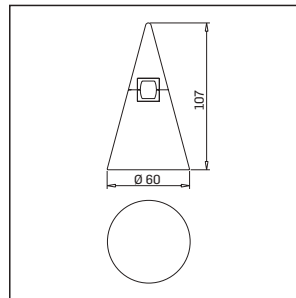

- SST1383DO
- SST1383PT



<b>SST1384</b>	
Dim. (mm)	Ø100 x A142
Potência	5W
Tem. Cor	3000K
Voltagem	24V
Fluxo (lm)	200 lm
IRC	>90
Material	Alumínio + Vidro
Acabamento	Dourado / Preto
Garantia	3 anos

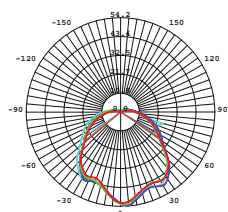
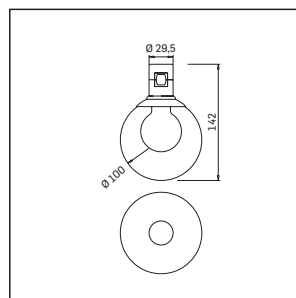

- SST1384DO
- SST1384PT



SST1385	
Dim. (mm)	Ø29,5 x 149
Potência	5W
Tem. Cor	3000K
Voltagem	24V
Fluxo (lm)	200 lm
IRC	>90
Material	Alumínio + Acrílico
Acabamento	Dourado / Preto
Garantia	3 anos

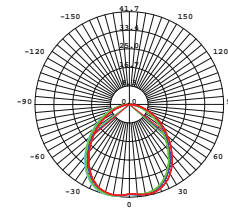
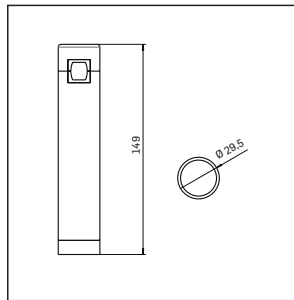

120°

- SST1385DO
- SST1385PT



SST1387	
Dim. (mm)	250 x 26 x 44
Potência	10W
Tem. Cor	3000K
Voltagem	24V
Fluxo (lm)	492 lm
IRC	>90
Material	Alumínio + Acrílico
Acabamento	Dourado / Preto
Garantia	3 anos

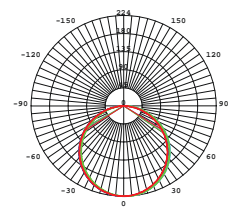
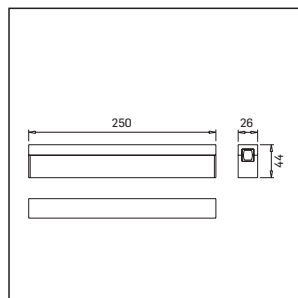

120°

- SST1387DO
- SST1387PT

MODULAR MAGNETIC SYSTEM / MÓDULO DE METAL PARA SISTEMA



MODULAR MAGNETIC SYSTEM / COMPONENTES



PORTA DRIVER

<b>BST1391</b>	
Dim. (mm)	Ø70 x A350
Material	Alumínio
Acabamento	Dourado / Preto
Garantia	3 anos

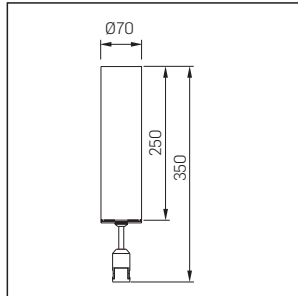

- BST1391DO
- BST1391PT

PORTA DRIVER

<b>BST1392</b>	
Dim. (mm)	Ø70 x A730
Material	Alumínio
Acabamento	Dourado / Preto
Garantia	3 anos

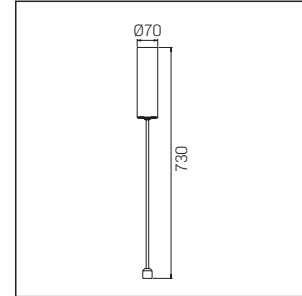

- BST1392DO
- BST1392PT

HASTE INTERMEDIÁRIA

<b>TST1396</b>	
Dim. (mm)	Ø20 x A280
Material	Alumínio
Acabamento	Dourado / Preto
Garantia	3 anos

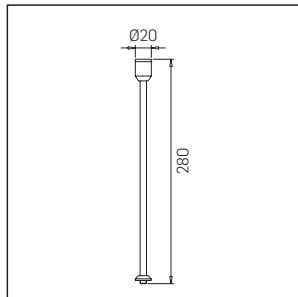

- TST1396DO
- TST1396PT

HASTE INTERMEDIÁRIA

<b>TST1397</b>	
Dim. (mm)	Ø20 x A684
Material	Alumínio
Acabamento	Dourado / Preto
Garantia	3 anos

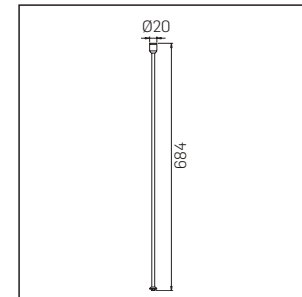

- TST1397DO
- TST1397PT

HASTE TERMINAL

<b>TST1398</b>	
Dim. (mm)	Ø29,5 x A326
Material	Alumínio
Acabamento	Dourado / Preto
Garantia	3 anos

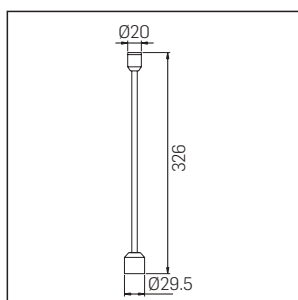

- TST1398DO
- TST1398PT

HASTE TERMINAL

<b>TST1398P</b>	
Dim. (mm)	Ø29,5 x A278
Material	Alumínio
Acabamento	Dourado / Preto
Garantia	3 anos

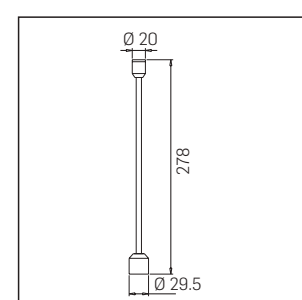

- TST1398PDO
- TST1398PPT

HASTE TERMINAL

**TST1399**

Dim. (mm) Ø29,5 x A730

Material Alumínio

Acabamento Dourado / Preto

Garantia 3 anos

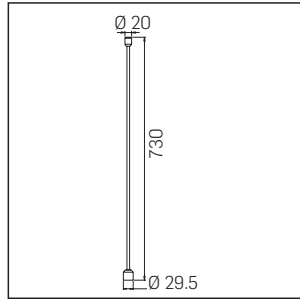

- TST1399DO
- TST1399PT

HASTE TERMINAL

**TST1399P**

Dim. (mm) Ø29,5 x A682

Material Alumínio

Acabamento Dourado / Preto

Garantia 3 anos

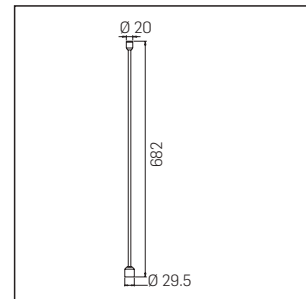

- TST1399PDO
- TST1399PPT

TRILHO

**TST1393**

Dim. (mm) C1000 x A33,2

Material Alumínio

Acabamento Dourado / Preto

Garantia 3 anos

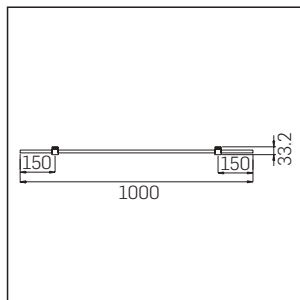

- TST1393DO
- TST1393PT

TRILHO

**TST1394**

Dim. (mm) C1000 x A53

Material Alumínio

Acabamento Dourado / Preto

Garantia 3 anos

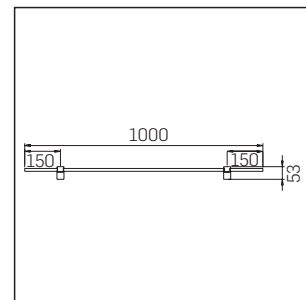

- TST1394DO
- TST1394PT

MODULAR MAGNETIC SYSTEM / COMPONENTES

TRILHO

**TST1395**

Dim. (mm) C1000 x A59,2

Material Alumínio

Acabamento Dourado / Preto

Garantia 3 anos

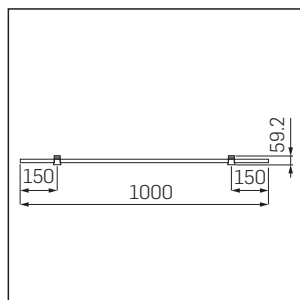

- TST1395DO
- TST1395PT

TRILHO

**TST1477**

Dim. (mm) C1500 x A33,2

Material Alumínio

Acabamento Dourado / Preto

Garantia 3 anos

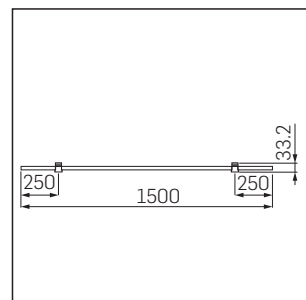

- TST1477DO
- TST1477PT

TRILHO

**TST1478**

Dim. (mm)	C1500 x A53
Material	Alumínio
Acabamento	Dourado / Preto
Garantia	3 anos

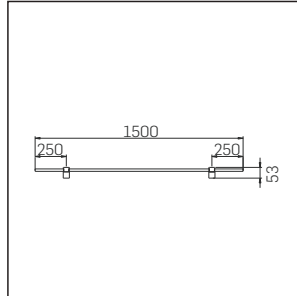

- TST1478DO
- TST1478PT

TRILHO

**TST1479**

Dim. (mm)	C1500 x A59,2
Material	Alumínio
Acabamento	Dourado / Preto
Garantia	3 anos

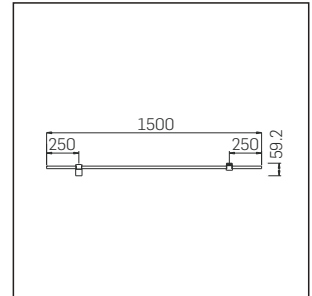

- TST1479DO
- TST1479PT

TRILHO

**TST1480**

Dim. (mm)	C2000 x A33,2
Material	Alumínio
Acabamento	Dourado / Preto
Garantia	3 anos

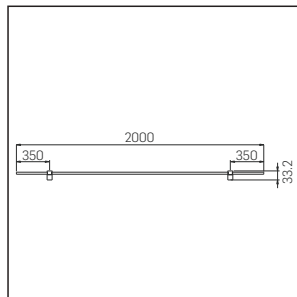

- TST1480DO
- TST1480PT

TRILHO

**TST1481**

Dim. (mm)	C2000 x A53
Material	Alumínio
Acabamento	Dourado / Preto
Garantia	3 anos

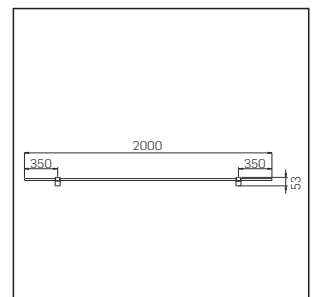

- TST1481DO
- TST1481PT

TRILHO

**TST1482**

Dim. (mm)	C2000 x A59,2
Material	Alumínio
Acabamento	Dourado / Preto
Garantia	3 anos

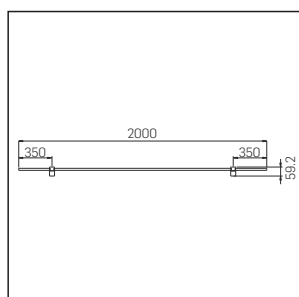

- TST1482DO
- TST1482PT



**PST1389**

Dim. (mm) Ø800 x 1200

Material Alumínio

Acabamento Dourado / Preto

Garantia 3 anos

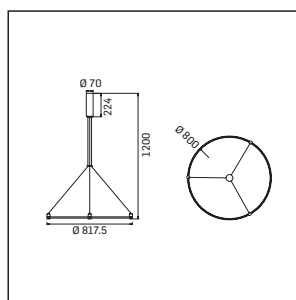

- PST1389DO
- PST1389PT





# TRILHOS/COMPONENTES

● Sistema curto

● Sistema longo

● Componente utilizado apenas em sistemas com número par de trilhos

## ■ PORTA DRIVER



## ■ HASTE INTERMEDIÁRIA

Utilizada entre o porta driver e a haste terminal em todos os sistemas com mais de 1 trilho

## ■ HASTE TERMINAL



## ■ TRILHO

1000mm

1500 mm

2000 mm











# CANOPLA SLIM PARA GESSO

Fácil instalação, proporciona um ambiente clean e permite maior variedade em suas composições. Para a instalação, é necessária a desmontagem do produto original e alocar o driver no teto, permanecendo embutido no gesso.



- CAN009DO
  - CAN009PT
- Ø55 mm

Compatíveis com:

- PD1508PT / PD1508DO
- PD1488DO / PD1488PT
- PD1475
- PD1494 / PD1495

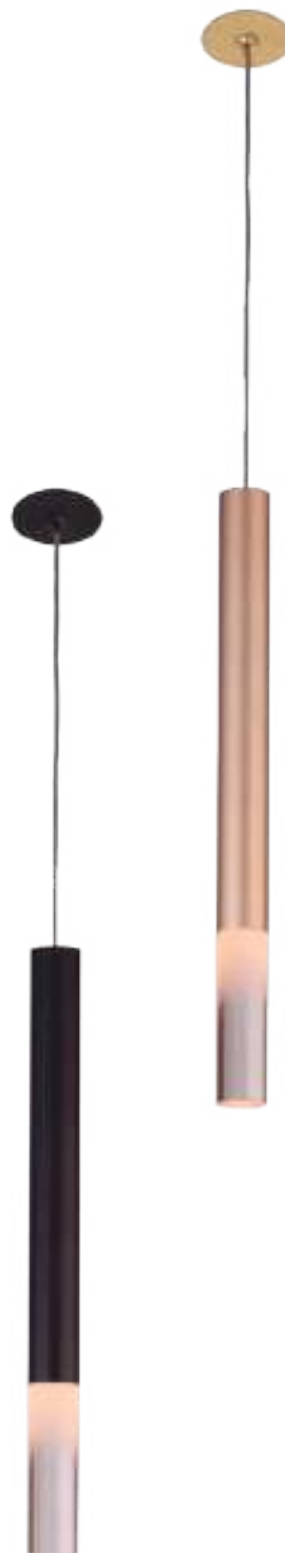



PD1508PT

studioluce.com.br



@studioluceiluminacao



/studioluceiluminacao



/@studioluceiluminacao



Studioluce  
ILUMINAÇÃO