

SOLIDE

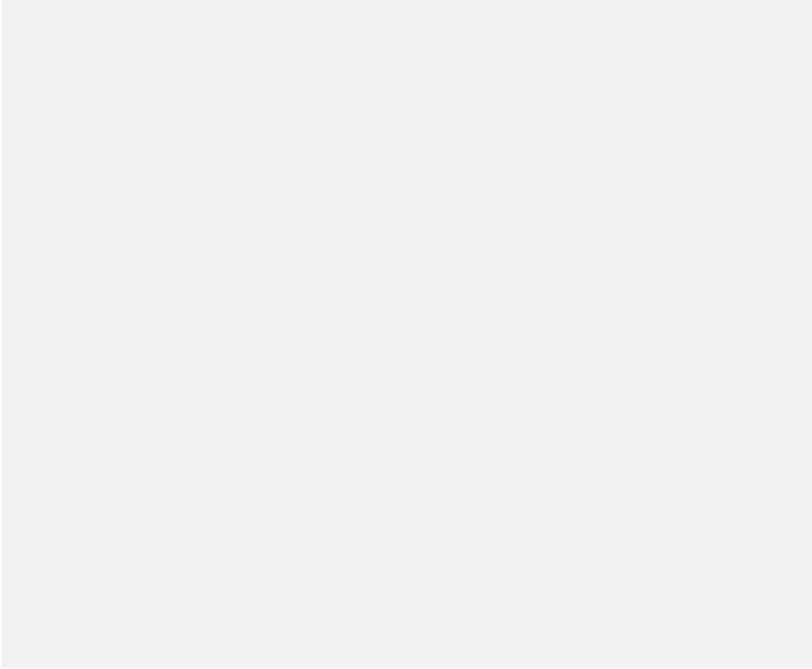

Com ampla experiência na elaboração de projetos diversificados, o arquiteto e designer JORGE ELMOR comanda o ESTUDIO ELMOR, que prioriza integrar referências da arquitetura mundial, novas tendências e aspectos regionalistas na concepção de seus trabalhos. Com vivências profissionais internacionais, que incluem países como Japão, Espanha, Áustria e Estados Unidos, busca trabalhar com a união do que há de melhor nos estilos e técnicas que conheceu pelo mundo; criando, dessa forma, o novo. A sustentabilidade é também um dos conceitos valorizados pelo ESTUDIO ELMOR, que acredita ser possível unir estilo e sofisticação ao uso racional de materiais e tecnologia.



Dinâmica e minimalista, a Linha **SOLIDE** captura a essência dos sólidos geométricos para transformá-los em elegantes peças de iluminação. Mostra versatilidade e permite várias composições e usos distintos; podem ser usadas como arandelas, balizadores ou até como **penduradores/cabideiro**. Seu sistema blindado de iluminação possibilita a aplicação tanto em áreas **internas** quanto **externas**.

Quando utilizada em composição, de maneira orgânica ou geométrica, torna-se uma verdadeira obra de arte luminotécnica. Devido ao seu sistema de fixação, é possível mudar a direção dos feixes de luz, ampliando ainda mais os efeitos e composições das luminárias.

A linha **SOLIDE** é lúdica, e apresenta peças com funcionalidade e criatividade.



CONE G



Feixe de luz
direcionável

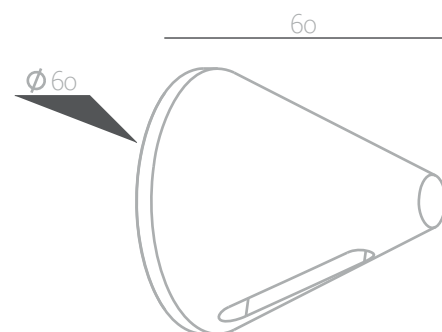

Corpo torneado em alumínio
Pintura para ambientes externos:
base epóxi
Pintura para ambientes internos :
base líquida
Módulo de led incluso: 110 ou 220v
Potência: 1,9w - Temperatura: 2700k
Proteção: **IP65**



Feixe de luz
direcionável



CONE G

CONE M

Feixe de luz
direcionável

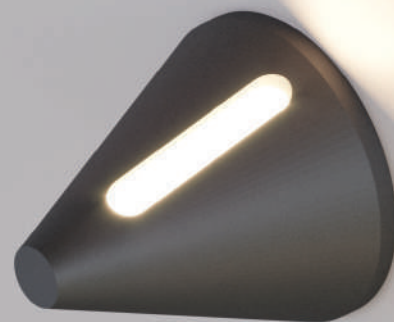
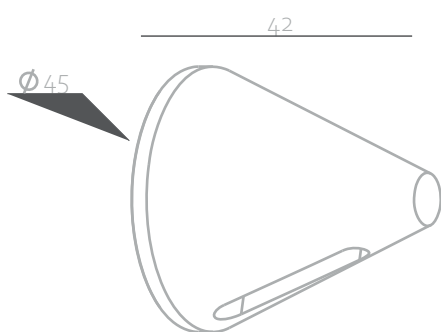

Corpo torneado em alumínio
Pintura para ambientes externos:
base epóxi
Pintura para ambientes internos :
base líquida
Módulo de led incluso: 110 ou 220v
Potência: 1,9w - Temperatura: 2700k
Proteção: **IP65**

CYLINDER G

Feixe de luz
direcionável



Pendurador/
Cabideiro

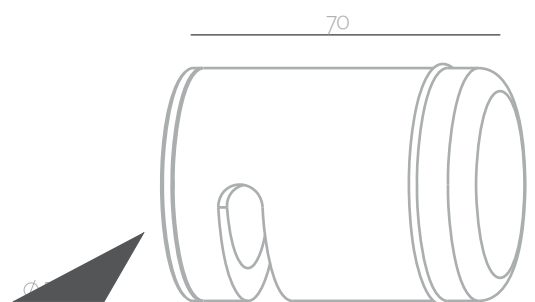

Corpo torneado em alumínio
Pintura para ambientes externos:
base epóxi
Pintura para ambientes internos :
base líquida
Módulo de led incluso: 110 ou 220v
Potência: 1,9w - Temperatura: 2700k
Proteção: **IP65**



Feixe de luz
direccionável



Pendurador/
Cabideiro



CYLINDER G

CYLINDER M

Feixe de luz
direccionável



Pendurador/
Cabideiro

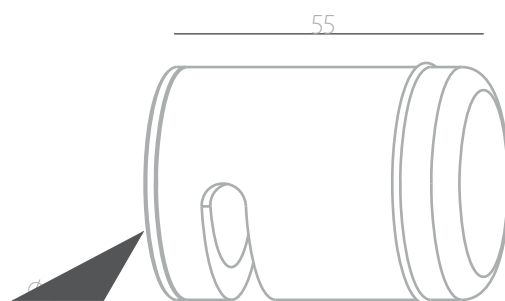

Corpo torneado em alumínio
Pintura para ambientes externos:
base epóxi
Pintura para ambientes internos :
base líquida
Módulo de led incluso: 110 ou 220v
Potência: 1,9w - Temperatura: 2700k
Proteção: **IP65**

pintura base epóxi

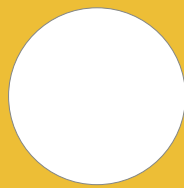

branco

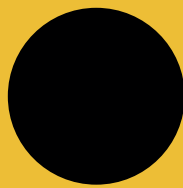

preto



nude

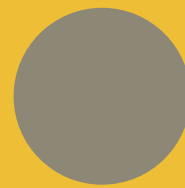

grafite

novidades

pintura base líquida



dourado
areia



dourado
colonial



dourado
real



dourado
klaxon



ouro
libra



dourado
terra



dourado
amêndoa



champagne



prata
klaxon



cobre
klaxon

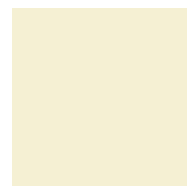

duo
color



nude
|B



nude
|F



branco
|B



branco
|F

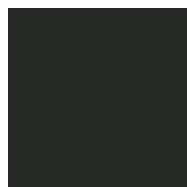

ônix
|B



ônix
|F



preto
|B



preto
|F

pintura

CORES especiais

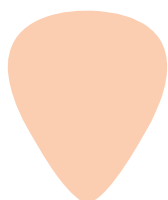

gengibre

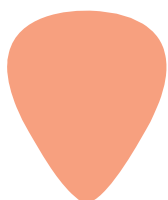

merkén

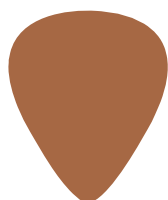

canela

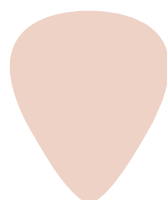

macis

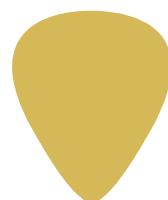

lemon pepper

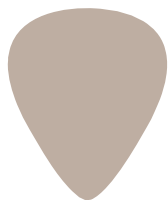

noz

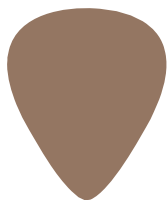

cominho

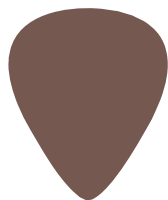

linhaça

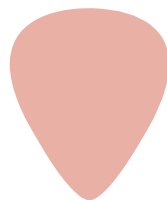

cajun

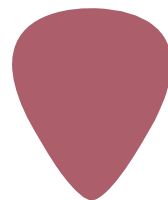

páprica

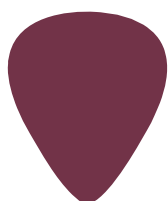

sumagre



pinoli



louro



gergelin

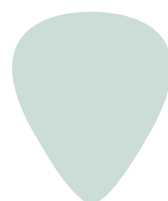

alecrim



cardamomo



tomilho

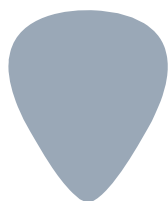

mirtilo

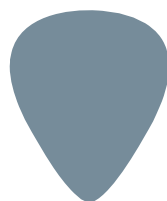

anis



zimbro

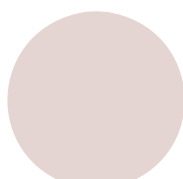

pearl

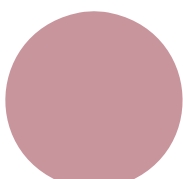

lace

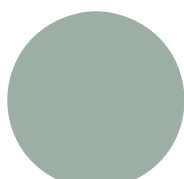

grass

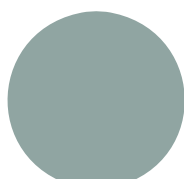

breeze

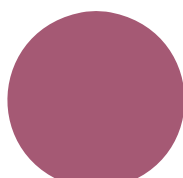

carmin

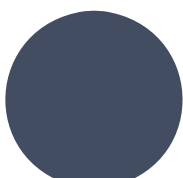

sky

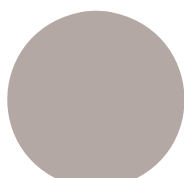

cord

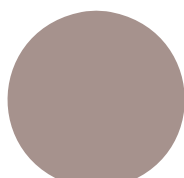

desert

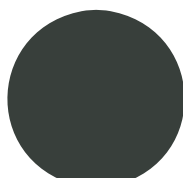

grain

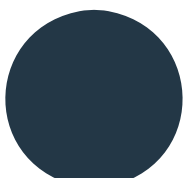

maritime

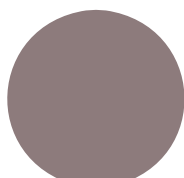

flow

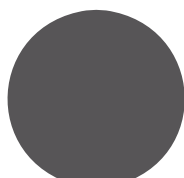

asphalt

metalizadas

f klaxon.distribuidora
@ klaxonbrasil

siga nossas redes sociais

Rua Salgado Filho, 570
Pineville
Pinhais - Paraná - Brasil
+ 55 413091-8300