



CONCEPTU

ILUMINAÇÃO

CATÁLOGO

PER_
FIS
E SISTEMAS

TABELA DE CORES

PINTURA
SÓLIDA

BR
BRANCO
BRILHO

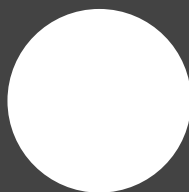

BF
BRANCO
MICROTEXTURIZADO

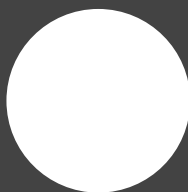

CZ
CINZA FOSCO



PTO
PRETO
MICROTEXTURIZADO



NU
NUDE



CO
COURO



MA
MARROM



PINTURA
ESPECIAL

CB
COBRE

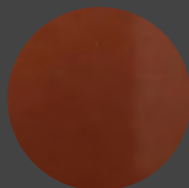

OR
OURO FOSCO

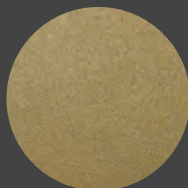

OB
OURO BRILHO

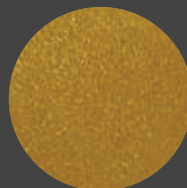

PTA
PRATA BRILHO



PODE HAVER
VARIÇÕES NAS
CORES EM VIRTUDE
DA IMPRESSÃO;
SOLICITE SUA
AMOSTRA DE CORES.

A UTILIZAÇÃO DE
CORES ESCURAS PODE
COMPROMETER O
EFEITO DE ALGUMAS
LUMINÁRIAS.

TODAS AS CORES ESTÃO DISPONÍVEIS PARA TODAS AS PEÇAS

A CONCEPTU ILUMINAÇÃO SE RESERVA O DIREITO DE MODIFICAR AS PEÇAS E AS CORES SEM AVISO PRÉVIO

ÍNDICE

PI	4	METRO	20
IARA	6	TUPĂ	22
CLOSE SLIM SOBREPOR	7	CANOA	23
CLOSE SLIM EMBUTIR	10	FRAMES	24
GUI	11	TRIAD	28
BORÉ	12	DOUBLE	30
FIT SOBREPOR	14	PARES	32
FIT EMBUTIR	16	HEXA	34
CLOSE	17	SPOT FOX	37
METRO NO FRAME	18	SPOT BOTTI	37
SLIM NO FRAME	19		

PI

PERFIL EM ALUMÍNIO COM
ACABAMENTO EM PINTURA
ELETROSTÁTICA E DIFUSOR
EM POLICARBONATO.

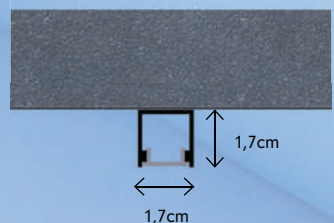

FONTE NÃO INCLUSA

PREVER ALOJAMENTO PARA FONTE REMOTA

MEDIDAS EM CENTÍMETROS

PERFIL

	L	H	C
5049-00	1.7	1.7	M
5049-01	1.7	1.7	100
5049-02	1.7	1.7	150
5049-03	1.7	1.7	200
5049-04	1.7	1.7	250
5049-05	1.7	1.7	300

PERFIL LED INTEGRADO BAIXA POTÊNCIA

	L	H	C	
5049-06	1.7	1.7	M	LED INTEGRADO 2700K 1200Lm/m 14,5W/m 12V
5049-07	1.7	1.7	100	LED INTEGRADO 2700K 1200Lm 14,5W 12V
5049-08	1.7	1.7	150	LED INTEGRADO 2700K 1800Lm 22W 12V
5049-09	1.7	1.7	200	LED INTEGRADO 2700K 2400Lm 29W 12V
5049-10	1.7	1.7	250	LED INTEGRADO 2700K 3000Lm 37W 12V
5049-11	1.7	1.7	300	LED INTEGRADO 2700K 3600Lm 44W 12V
5049-12	1.7	1.7	M	LED INTEGRADO 4000K 1200Lm/m 14,5W/m 12V
5049-13	1.7	1.7	100	LED INTEGRADO 4000K 1200Lm 14,5W 12V
5049-14	1.7	1.7	150	LED INTEGRADO 4000K 1800Lm 22W 12V
5049-15	1.7	1.7	200	LED INTEGRADO 4000K 2400Lm 29W 12V
5049-16	1.7	1.7	250	LED INTEGRADO 4000K 3000Lm 37W 12V
5049-17	1.7	1.7	300	LED INTEGRADO 4000K 3600Lm 44W 12V

PERFIL LED INTEGRADO ALTA POTÊNCIA

	L	H	C	
5049-18	1.7	1.7	M	LED INTEGRADO 3000K 3120Lm/m 20W/m 24V
5049-19	1.7	1.7	100	LED INTEGRADO 3000K 3120Lm 20W 24V
5049-20	1.7	1.7	150	LED INTEGRADO 3000K 4680Lm 30W 24V
5049-21	1.7	1.7	200	LED INTEGRADO 3000K 6240Lm 40W 24V
5049-22	1.7	1.7	250	LED INTEGRADO 3000K 7800Lm 50W 24V
5049-23	1.7	1.7	300	LED INTEGRADO 3000K 9360Lm 60W 24V
5049-24	1.7	1.7	M	LED INTEGRADO 4000K 3120Lm/m 20W/m 24V
5049-25	1.7	1.7	100	LED INTEGRADO 4000K 3120Lm 20W 24V
5049-26	1.7	1.7	150	LED INTEGRADO 4000K 4680Lm 30W 24V
5049-27	1.7	1.7	200	LED INTEGRADO 4000K 6240Lm 40W 24V
5049-28	1.7	1.7	250	LED INTEGRADO 4000K 7800Lm 50W 24V
5049-29	1.7	1.7	300	LED INTEGRADO 4000K 9360Lm 60W 24V

ACESSÓRIOS

5049-30	KIT 10 TAMPAS PI
5049-31	JUNÇÃO PI TETO TETO
5049-32	JUNÇÃO PI TETO PAREDE

OUTRAS MEDIDAS SOB CONSULTA

ARANDELA LUZ DIRETA

	L	H	C	
3152-00	1.7	1.7	60	
3152-01	1.7	1.7	120	
3152-02	1.7	1.7	170	
3152-03	1.7	1.7	60	LED INTEGRADO 2700K 720LM 9W 12V
3152-04	1.7	1.7	120	LED INTEGRADO 2700K 1440LM 18W 12V
3152-05	1.7	1.7	170	LED INTEGRADO 2700K 2040LM 25W 12V
3152-06	1.7	1.7	60	LED INTEGRADO 3000K 720LM 9W 12V
3152-07	1.7	1.7	120	LED INTEGRADO 3000K 1440LM 18W 12V
3152-08	1.7	1.7	170	LED INTEGRADO 3000K 2040LM 25W 12V

PLAFON LUZ DIRETA

	L	H	C	
2138-00	1.7	1.7	60	
2138-01	1.7	1.7	120	
2138-02	1.7	1.7	170	
2138-03	1.7	1.7	60	LED INTEGRADO 3000K 1870LM 12W 24V
2138-04	1.7	1.7	120	LED INTEGRADO 3000K 3750LM 24W 24V
2138-05	1.7	1.7	170	LED INTEGRADO 3000K 5300LM 34W 24V
2138-06	1.7	1.7	60	LED INTEGRADO 4000K 1870LM 12W 24V
2138-07	1.7	1.7	120	LED INTEGRADO 4000K 3750LM 24W 24V
2138-08	1.7	1.7	170	LED INTEGRADO 4000K 5300LM 34W 24V

PENDENTE LUZ DIRETA

	L	H	C	H MÁX	
1191-00	1.7	1.7	60	150	
1191-01	1.7	1.7	120	150	
1191-02	1.7	1.7	170	150	
1191-03	1.7	1.7	60	150	LED INTEGRADO 3000K 1870LM 12W 24V
1191-04	1.7	1.7	120	150	LED INTEGRADO 3000K 3750LM 24W 24V
1191-05	1.7	1.7	170	150	LED INTEGRADO 3000K 5300LM 34W 24V
1191-06	1.7	1.7	60	150	LED INTEGRADO 4000K 1870LM 12W 24V
1191-07	1.7	1.7	120	150	LED INTEGRADO 4000K 3750LM 24W 24V
1191-08	1.7	1.7	170	150	LED INTEGRADO 4000K 5300LM 34W 24V

ARANDELA LUZ INDIRETA

	L	H	C	
3152-00	1.7	4.5	60	
3152-01	1.7	4.5	120	
3152-02	1.7	4.5	170	
3152-03	1.7	4.5	60	LED INTEGRADO 2700K 720LM 9W 12V
3152-04	1.7	4.5	120	LED INTEGRADO 2700K 1440LM 18W 12V
3152-05	1.7	4.5	170	LED INTEGRADO 2700K 2040LM 25W 12V
3152-06	1.7	4.5	60	LED INTEGRADO 3000K 720LM 9W 12V
3152-07	1.7	4.5	120	LED INTEGRADO 3000K 1440LM 18W 12V
3152-08	1.7	4.5	170	LED INTEGRADO 3000K 2040LM 25W 12V

PLAFON LUZ INDIRETA

	L	H	C	
2138-00	1.7	4.5	60	
2138-01	1.7	4.5	120	
2138-02	1.7	4.5	170	
2138-03	1.7	4.5	60	LED INTEGRADO 3000K 1870LM 12W 24V
2138-04	1.7	4.5	120	LED INTEGRADO 3000K 3750LM 24W 24V
2138-05	1.7	4.5	170	LED INTEGRADO 3000K 5300LM 34W 24V
2138-06	1.7	4.5	60	LED INTEGRADO 4000K 1870LM 12W 24V
2138-07	1.7	4.5	120	LED INTEGRADO 4000K 3750LM 24W 24V
2138-08	1.7	4.5	170	LED INTEGRADO 4000K 5300LM 34W 24V

PENDENTE LUZ INDIRETA

	L	H	C	H MÁX	
1191-00	1.7	1.7	60	150	
1191-01	1.7	1.7	120	150	
1191-02	1.7	1.7	170	150	
1191-03	1.7	1.7	60	150	LED INTEGRADO 3000K 1870LM 12W 24V
1191-04	1.7	1.7	120	150	LED INTEGRADO 3000K 3750LM 24W 24V
1191-05	1.7	1.7	170	150	LED INTEGRADO 3000K 5300LM 34W 24V
1191-06	1.7	1.7	60	150	LED INTEGRADO 4000K 1870LM 12W 24V
1191-07	1.7	1.7	120	150	LED INTEGRADO 4000K 3750LM 24W 24V
1191-08	1.7	1.7	170	150	LED INTEGRADO 4000K 5300LM 34W 24V

IARA

PERFIL EM ALUMÍNIO COM
ACABAMENTO EM PINTURA
ELETROSTÁTICA E DIFUSOR
EM POLICARBONATO.

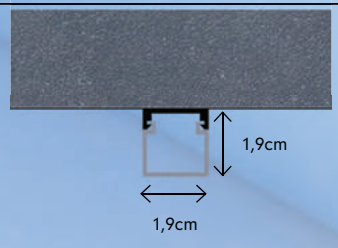

FORNE NÃO INCLUSA

PREVER ALOJAMENTO PARA FORNE REMOTA

MEDIDAS EM CENTÍMETROS

PERFIL

	L	H	C
5052-00	1.9	1.9	M
5052-01	1.9	1.9	100
5052-02	1.9	1.9	150
5052-03	1.9	1.9	200
5052-04	1.9	1.9	250
5052-05	1.9	1.9	300

PERFIL LED INTEGRADO BAIXA POTÊNCIA

	L	H	C	
5052-06	1.9	1.9	M	LED INTEGRADO 2700K 1200Lm/m 14,5W/m 12V
5052-07	1.9	1.9	100	LED INTEGRADO 2700K 1200Lm 14,5W 12V
5052-08	1.9	1.9	150	LED INTEGRADO 2700K 1800Lm 22W 12V
5052-09	1.9	1.9	200	LED INTEGRADO 2700K 2400Lm 29W 12V
5052-10	1.9	1.9	250	LED INTEGRADO 2700K 3000Lm 37W 12V
5052-11	1.9	1.9	300	LED INTEGRADO 2700K 3600Lm 44W 12V

5052-12	1.9	1.9	M	LED INTEGRADO 4000K 1200Lm/m 14,5W/m 12V
5052-13	1.9	1.9	100	LED INTEGRADO 4000K 1200Lm 14,5W 12V
5052-14	1.9	1.9	150	LED INTEGRADO 4000K 1800Lm 22W 12V
5052-15	1.9	1.9	200	LED INTEGRADO 4000K 2400Lm 29W 12V
5052-16	1.9	1.9	250	LED INTEGRADO 4000K 3000Lm 37W 12V
5052-17	1.9	1.9	300	LED INTEGRADO 4000K 3600Lm 44W 12V

PERFIL LED INTEGRADO ALTA POTÊNCIA

	L	H	C	
5052-18	1.9	1.9	M	LED INTEGRADO 3000K 3120Lm/m 20W/m 24V
5052-19	1.9	1.9	100	LED INTEGRADO 3000K 3120Lm 20W 24V
5052-20	1.9	1.9	150	LED INTEGRADO 3000K 4680Lm 30W 24V
5052-21	1.9	1.9	200	LED INTEGRADO 3000K 6240Lm 40W 24V
5052-22	1.9	1.9	250	LED INTEGRADO 3000K 7800Lm 50W 24V
5052-23	1.9	1.9	300	LED INTEGRADO 3000K 9360Lm 60W 24V

5052-24	1.9	1.9	M	LED INTEGRADO 4000K 3120Lm/m 20W/m 24V
5052-25	1.9	1.9	100	LED INTEGRADO 4000K 3120Lm 20W 24V
5052-26	1.9	1.9	150	LED INTEGRADO 4000K 4680Lm 30W 24V
5052-27	1.9	1.9	200	LED INTEGRADO 4000K 6240Lm 40W 24V
5052-28	1.9	1.9	250	LED INTEGRADO 4000K 7800Lm 50W 24V
5052-29	1.9	1.9	300	LED INTEGRADO 4000K 9360Lm 60W 24V

ACESSÓRIOS

5052-29	KIT 10 TAMPAS IARA
5052-31	JUNÇÃO IARA TETO TETO
5052-32	JUNÇÃO IARA TETO PAREDE

OUTRAS MEDIDAS SOB CONSULTA

ARANDELA LUZ DIRETA

	L	H	C	
3153-00	1.9	1.9	60	
3153-01	1.9	1.9	120	
3153-02	1.9	1.9	170	
3153-03	1.9	1.9	60	LED INTEGRADO 2700K 720LM 9W 12V
3153-04	1.9	1.9	120	LED INTEGRADO 2700K 1440LM 18W 12V
3153-05	1.9	1.9	170	LED INTEGRADO 2700K 2040LM 25W 12V
3153-06	1.9	1.9	60	LED INTEGRADO 3000K 720LM 9W 12V
3153-07	1.9	1.9	120	LED INTEGRADO 3000K 1440LM 18W 12V
3153-08	1.9	1.9	170	LED INTEGRADO 3000K 2040LM 25W 12V

PLAFON LUZ DIRETA

	L	H	C	
2139-00	1.9	1.9	60	
2139-01	1.9	1.9	120	
2139-02	1.9	1.9	170	
2139-03	1.9	1.9	60	LED INTEGRADO 3000K 1870LM 12W 24V
2139-04	1.9	1.9	120	LED INTEGRADO 3000K 3750LM 24W 24V
2139-05	1.9	1.9	170	LED INTEGRADO 3000K 5300LM 34W 24V
2139-06	1.9	1.9	60	LED INTEGRADO 4000K 1870LM 12W 24V
2139-07	1.9	1.9	120	LED INTEGRADO 4000K 3750LM 24W 24V
2139-08	1.9	1.9	170	LED INTEGRADO 4000K 5300LM 34W 24V

PENDENTE LUZ DIRETA

	L	H	C	H MÁX
1192-00	1.9	1.9	60	
1192-01	1.9	1.9	120	
1192-02	1.9	1.9	170	
1192-03	1.9	1.9	60	LED INTEGRADO 3000K 1870LM 12W 24V
1192-04	1.9	1.9	120	LED INTEGRADO 3000K 3750LM 24W 24V
1192-05	1.9	1.9	170	LED INTEGRADO 3000K 5300LM 34W 24V
1192-06	1.9	1.9	60	LED INTEGRADO 4000K 1870LM 12W 24V
1192-07	1.9	1.9	120	LED INTEGRADO 4000K 3750LM 24W 24V
1192-08	1.9	1.9	170	LED INTEGRADO 4000K 5300LM 34W 24V

CLOSE SLIM

SOBREPOR

PERFIL EM ALUMÍNIO COM ACABAMENTO EM PINTURA ELETROSTÁTICA E DIFUSOR EM POLICARBONATO.

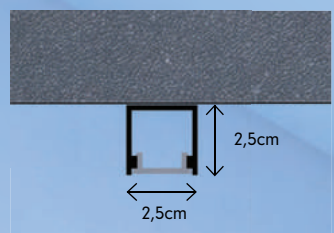

FONTE NÃO INCLUSA

PREVER ALOJAMENTO PARA FONTE REMOTA

MEDIDAS EM CENTÍMETROS

PERFIL

	L	H	C
5033-00	2.5	2.5	M
5033-01	2.5	2.5	100
5033-02	2.5	2.5	150
5033-03	2.5	2.5	200
5033-04	2.5	2.5	250
5033-05	2.5	2.5	300

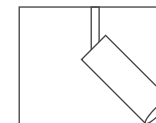

SPOT PARA PERFIL

	L	H	C	LÂMPADAS
4191	4	12	4	1xMINIDICRÓICA
4192	6	12	6	1xDICRÓICA
4193	7,5	12	7,5	1xAR70

PERFIL LED INTEGRADO BAIXA POTÊNCIA

	L	H	C	
5033-06	2.5	2.5	M	LED INTEGRADO 2700K 1200Lm/m 14,5W/m 12V
5033-07	2.5	2.5	100	LED INTEGRADO 2700K 1200Lm 14,5W 12V
5033-08	2.5	2.5	150	LED INTEGRADO 2700K 1800Lm 22W 12V
5033-09	2.5	2.5	200	LED INTEGRADO 2700K 2400Lm 29W 12V
5033-10	2.5	2.5	250	LED INTEGRADO 2700K 3000Lm 37W 12V
5033-11	2.5	2.5	300	LED INTEGRADO 2700K 3600Lm 44W 12V
5033-12	2.5	2.5	M	LED INTEGRADO 4000K 1200Lm/m 14,5W/m 12V
5033-13	2.5	2.5	100	LED INTEGRADO 4000K 1200Lm 14,5W 12V
5033-14	2.5	2.5	150	LED INTEGRADO 4000K 1800Lm 22W 12V
5033-15	2.5	2.5	200	LED INTEGRADO 4000K 2400Lm 29W 12V
5033-16	2.5	2.5	250	LED INTEGRADO 4000K 3000Lm 37W 12V
5033-17	2.5	2.5	300	LED INTEGRADO 4000K 3600Lm 44W 12V

PERFIL LED INTEGRADO ALTA POTÊNCIA

	L	H	C	
5033-18	2.5	2.5	M	LED INTEGRADO 3000K 3120Lm/m 20W/m 24V
5033-19	2.5	2.5	100	LED INTEGRADO 3000K 3120Lm 20W 24V
5033-20	2.5	2.5	150	LED INTEGRADO 3000K 4680Lm 30W 24V
5033-21	2.5	2.5	200	LED INTEGRADO 3000K 6240Lm 40W 24V
5033-22	2.5	2.5	250	LED INTEGRADO 3000K 7800Lm 50W 24V
5033-23	2.5	2.5	300	LED INTEGRADO 3000K 9360Lm 60W 24V
5033-24	2.5	2.5	M	LED INTEGRADO 4000K 3120Lm/m 20W/m 24V
5033-25	2.5	2.5	100	LED INTEGRADO 4000K 3120Lm 20W 24V
5033-26	2.5	2.5	150	LED INTEGRADO 4000K 4680Lm 30W 24V
5033-27	2.5	2.5	200	LED INTEGRADO 4000K 6240Lm 40W 24V
5033-28	2.5	2.5	250	LED INTEGRADO 4000K 7800Lm 50W 24V
5033-29	2.5	2.5	300	LED INTEGRADO 4000K 9360Lm 60W 24V

ACESSÓRIOS

5033-30	KIT 10 TAMPAS CLOSE SLIM DE SOBREPOR
5033-31	JUNÇÃO CLOSE SLIM SOBREPOR TETO TETO
5033-32	JUNÇÃO CLOSE SLIM SOBREPOR TETO PAREDE

ARANDELA LUZ DIRETA

	L	H	C	
3151-00	2.5	2.5	60	
3151-01	2.5	2.5	120	
3151-02	2.5	2.5	170	
3151-03	2.5	2.5	60	LED INTEGRADO 2700K 720LM 9W 12V
3151-04	2.5	2.5	120	LED INTEGRADO 2700K 1440LM 18W 12V
3151-05	2.5	2.5	170	LED INTEGRADO 2700K 2040LM 25W 12V
3151-06	2.5	2.5	60	LED INTEGRADO 3000K 720LM 9W 12V
3151-07	2.5	2.5	120	LED INTEGRADO 3000K 1440LM 18W 12V
3151-08	2.5	2.5	170	LED INTEGRADO 3000K 2040LM 25W 12V

PLAFON LUZ DIRETA

	L	H	C	
2137-00	2.5	2.5	60	
2137-01	2.5	2.5	120	
2137-02	2.5	2.5	170	
2137-03	2.5	2.5	60	LED INTEGRADO 3000K 1870LM 12W 24V
2137-04	2.5	2.5	120	LED INTEGRADO 3000K 3750LM 24W 24V
2137-05	2.5	2.5	170	LED INTEGRADO 3000K 5300LM 34W 24V
2137-06	2.5	2.5	60	LED INTEGRADO 4000K 1870LM 12W 24V
2137-07	2.5	2.5	120	LED INTEGRADO 4000K 3750LM 24W 24V
2137-08	2.5	2.5	170	LED INTEGRADO 4000K 5300LM 34W 24V

PENDENTE LUZ DIRETA

	L	H	C	H MÁX	
1190-00	2.5	2.5	60	150	
1190-01	2.5	2.5	120	150	
1190-02	2.5	2.5	170	150	
1190-03	2.5	2.5	60	150	LED INTEGRADO 3000K 1870LM 12W 24V
1190-04	2.5	2.5	120	150	LED INTEGRADO 3000K 3750LM 24W 24V
1190-05	2.5	2.5	170	150	LED INTEGRADO 3000K 5300LM 34W 24V
1190-06	2.5	2.5	60	150	LED INTEGRADO 4000K 1870LM 12W 24V
1190-07	2.5	2.5	120	150	LED INTEGRADO 4000K 3750LM 24W 24V
1190-08	2.5	2.5	170	150	LED INTEGRADO 4000K 5300LM 34W 24V

ARANDELA LUZ INDIRETA

	L	H	C	
3151-09	2.5	2.5	60	
3151-10	2.5	2.5	120	
3151-11	2.5	2.5	170	
3151-12	2.5	2.5	60	LED INTEGRADO 2700K 720LM 9W 12V
3151-13	2.5	2.5	120	LED INTEGRADO 2700K 1440LM 18W 12V
3151-14	2.5	2.5	170	LED INTEGRADO 2700K 2040LM 25W 12V
3151-15	2.5	2.5	60	LED INTEGRADO 3000K 720LM 9W 12V
3151-16	2.5	2.5	120	LED INTEGRADO 3000K 1440LM 18W 12V
3151-17	2.5	2.5	170	LED INTEGRADO 3000K 2040LM 25W 12V

PLAFON LUZ INDIRETA

	L	H	C	
2137-09	2.5	2.5	60	
2137-10	2.5	2.5	120	
2137-11	2.5	2.5	170	
2137-12	2.5	2.5	60	LED INTEGRADO 3000K 1870LM 12W 24V
2137-13	2.5	2.5	120	LED INTEGRADO 3000K 3750LM 24W 24V
2137-14	2.5	2.5	170	LED INTEGRADO 3000K 5300LM 34W 24V
2137-15	2.5	2.5	60	LED INTEGRADO 4000K 1870LM 12W 24V
2137-16	2.5	2.5	120	LED INTEGRADO 4000K 3750LM 24W 24V
2137-17	2.5	2.5	170	LED INTEGRADO 4000K 5300LM 34W 24V

PENDENTE LUZ INDIRETA

	L	H	C	H MÁX	
1190-06	2.5	2.5	60	150	
1190-07	2.5	2.5	120	150	
1190-08	2.5	2.5	170	150	
1190-09	2.5	2.5	60	150	LED INTEGRADO 3000K 1870LM 12W 24V
1190-10	2.5	2.5	120	150	LED INTEGRADO 3000K 3750LM 24W 24V
1190-11	2.5	2.5	170	150	LED INTEGRADO 3000K 5300LM 34W 24V
1190-12	2.5	2.5	60	150	LED INTEGRADO 4000K 1870LM 12W 24V
1190-13	2.5	2.5	120	150	LED INTEGRADO 4000K 3750LM 24W 24V
1190-14	2.5	2.5	170	150	LED INTEGRADO 4000K 5300LM 34W 24V

CLOSE SLIM

EMBUTIR

PERFIL EM ALUMÍNIO COM ACABAMENTO EM PINTURA ELETROSTÁTICA E DIFUSOR EM POLICARBONATO.

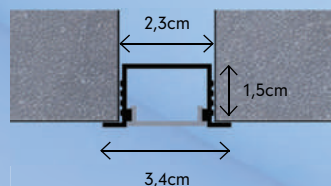

FONTE NÃO INCLUSA

PREVER ALOJAMENTO PARA FONTE REMOTA

MEDIDAS EM CENTÍMETROS

PERFIL

	L	H	C
5032-00	3.4	1.5	M
5032-01	3.4	1.5	100
5032-02	3.4	1.5	150
5032-03	3.4	1.5	200
5032-04	3.4	1.5	250
5032-05	3.4	1.5	300

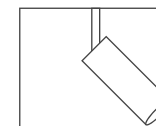

SPOT PARA PERFIL

	L	H	C	LÂMPADAS
4191	4	12	4	1xMINIDICRÓICA
4192	6	12	6	1xDICRÓICA
4193	7,5	12	7,5	1xAR70

PERFIL LED INTEGRADO BAIXA POTÊNCIA

	L	H	C	
5032-06	3.4	1.5	M	LED INTEGRADO 2700K 1200Lm/m 14,5W/m 12V
5032-07	3.4	1.5	100	LED INTEGRADO 2700K 1200Lm 14,5W 12V
5032-08	3.4	1.5	150	LED INTEGRADO 2700K 1800Lm 22W 12V
5032-09	3.4	1.5	200	LED INTEGRADO 2700K 2400Lm 29W 12V
5032-10	3.4	1.5	250	LED INTEGRADO 2700K 3000Lm 37W 12V
5032-11	3.4	1.5	300	LED INTEGRADO 2700K 3600Lm 44W 12V
5032-12	3.4	1.5	M	LED INTEGRADO 4000K 1200Lm/m 14,5W/m 12V
5032-13	3.4	1.5	100	LED INTEGRADO 4000K 1200Lm 14,5W 12V
5032-14	3.4	1.5	150	LED INTEGRADO 4000K 1800Lm 22W 12V
5032-15	3.4	1.5	200	LED INTEGRADO 4000K 2400Lm 29W 12V
5032-16	3.4	1.5	250	LED INTEGRADO 4000K 3000Lm 37W 12V
5032-17	3.4	1.5	300	LED INTEGRADO 4000K 3600Lm 44W 12V

PERFIL LED INTEGRADO ALTA POTÊNCIA

	L	H	C	
5032-18	3.4	1.5	M	LED INTEGRADO 3000K 3120Lm/m 20W/m 24V
5032-19	3.4	1.5	100	LED INTEGRADO 3000K 3120Lm 20W 24V
5032-20	3.4	1.5	150	LED INTEGRADO 3000K 4680Lm 30W 24V
5032-21	3.4	1.5	200	LED INTEGRADO 3000K 6240Lm 40W 24V
5032-22	3.4	1.5	250	LED INTEGRADO 3000K 7800Lm 50W 24V
5032-23	3.4	1.5	300	LED INTEGRADO 3000K 9360Lm 60W 24V
5032-24	3.4	1.5	M	LED INTEGRADO 4000K 3120Lm/m 20W/m 24V
5032-25	3.4	1.5	100	LED INTEGRADO 4000K 3120Lm 20W 24V
5032-26	3.4	1.5	150	LED INTEGRADO 4000K 4680Lm 30W 24V
5032-27	3.4	1.5	200	LED INTEGRADO 4000K 6240Lm 40W 24V
5032-28	3.4	1.5	250	LED INTEGRADO 4000K 7800Lm 50W 24V
5032-29	3.4	1.5	300	LED INTEGRADO 4000K 9360Lm 60W 24V

ACESSÓRIOS

5032-30	KIT 10 TAMPAS CLOSE SLIM DE EMBUTIR
5032-31	JUNÇÃO CLOSE SLIM EMBUTIR TETO TETO
5032-32	JUNÇÃO CLOSE SLIM EMBUTIR TETO PAREDE

GUI

PERFIL EM ALUMÍNIO COM ACABAMENTO EM PINTURA ELETROSTÁTICA E DIFUSOR EM POLICARBONATO.

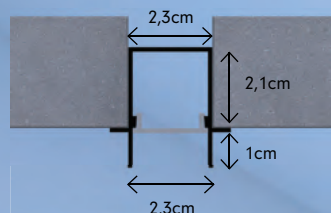

FONTE NÃO INCLUSA

PREVER ALOJAMENTO PARA FONTE REMOTA

MEDIDAS EM CENTÍMETROS

PERFIL

	L	H	C
5050-00	2.3	3.3	M
5050-01	2.3	3.3	100
5050-02	2.3	3.3	150
5050-03	2.3	3.3	200
5050-04	2.3	3.3	250
5050-05	2.3	3.3	300

PERFIL LED INTEGRADO BAIXA POTÊNCIA

	L	H	C	
5050-06	2.3	3.3	M	LED INTEGRADO 2700K 1200LM/M 14,5W/M 12V
5050-07	2.3	3.3	100	LED INTEGRADO 2700K 1200LM 14,5W 12V
5050-08	2.3	3.3	150	LED INTEGRADO 2700K 1800LM 22W 12V
5050-09	2.3	3.3	200	LED INTEGRADO 2700K 2400LM 29W 12V
5050-10	2.3	3.3	250	LED INTEGRADO 2700K 3000LM 37W 12V
5050-11	2.3	3.3	300	LED INTEGRADO 2700K 3600LM 44W 12V
5050-12	2.3	3.3	M	LED INTEGRADO 4000K 1200LM/M 14,5W/M 12V
5050-13	2.3	3.3	100	LED INTEGRADO 4000K 1200LM 14,5W 12V
5050-14	2.3	3.3	150	LED INTEGRADO 4000K 1800LM 22W 12V
5050-15	2.3	3.3	200	LED INTEGRADO 4000K 2400LM 29W 12V
5050-16	2.3	3.3	250	LED INTEGRADO 4000K 3000LM 37W 12V
5050-17	2.3	3.3	300	LED INTEGRADO 4000K 3600LM 44W 12V

PERFIL LED INTEGRADO ALTA POTÊNCIA

	L	H	C	
5050-18	2.3	3.3	M	LED INTEGRADO 3000K 3120LM/M 20W/M 24V
5050-19	2.3	3.3	100	LED INTEGRADO 3000K 3120LM 20W 24V
5050-20	2.3	3.3	150	LED INTEGRADO 3000K 4680LM 30W 24V
5050-21	2.3	3.3	200	LED INTEGRADO 3000K 6240LM 40W 24V
5050-22	2.3	3.3	250	LED INTEGRADO 3000K 7800LM 50W 24V
5050-23	2.3	3.3	300	LED INTEGRADO 3000K 9360LM 60W 24V
5050-24	2.3	3.3	M	LED INTEGRADO 4000K 3120LM/M 20W/M 24V
5050-25	2.3	3.3	100	LED INTEGRADO 4000K 3120LM 20W 24V
5050-26	2.3	3.3	150	LED INTEGRADO 4000K 4680LM 30W 24V
5050-27	2.3	3.3	200	LED INTEGRADO 4000K 6240LM 40W 24V
5050-28	2.3	3.3	250	LED INTEGRADO 4000K 7800LM 50W 24V
5050-29	2.3	3.3	300	LED INTEGRADO 4000K 9360LM 60W 24V

ACESSÓRIOS

5050-30	KIT 10 TAMPAS GUI
5050-31	JUNÇÃO GUI TETO TETO
5050-32	JUNÇÃO GUI TETO PAREDE

BORÉ

PERFIL EM ALUMÍNIO COM ACABAMENTO EM PINTURA ELETROSTÁTICA E DIFUSOR EM POLICARBONATO.

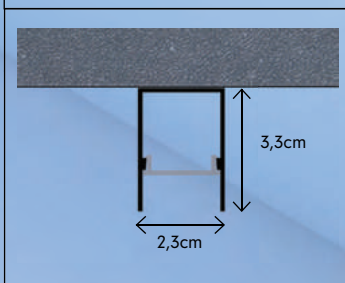

FONTE NÃO INCLUSA

PREVER ALOJAMENTO PARA FONTE REMOTA

MEDIDAS EM CENTÍMETROS

PERFIL

	L	H	C
5051-00	2.3	3.3	M
5051-01	2.3	3.3	100
5051-02	2.3	3.3	150
5051-03	2.3	3.3	200
5051-04	2.3	3.3	250
5051-05	2.3	3.3	300

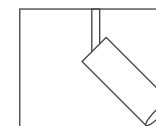

SPOT PARA PERFIL

	L	H	C	LÂMPADAS
4191	4	12	4	1xMINIDICRÓICA
4192	6	12	6	1xDICRÓICA
4193	7,5	12	7,5	1xAR70

PERFIL LED INTEGRADO BAIXA POTÊNCIA

	L	H	C	
5051-06	2.3	3.3	M	LED INTEGRADO 2700K 1200Lm/m 14,5W/m 12V
5051-07	2.3	3.3	100	LED INTEGRADO 2700K 1200Lm 14,5W 12V
5051-08	2.3	3.3	150	LED INTEGRADO 2700K 1800Lm 22W 12V
5051-09	2.3	3.3	200	LED INTEGRADO 2700K 2400Lm 29W 12V
5051-10	2.3	3.3	250	LED INTEGRADO 2700K 3000Lm 37W 12V
5051-11	2.3	3.3	300	LED INTEGRADO 2700K 3600Lm 44W 12V
5051-12	2.3	3.3	M	LED INTEGRADO 4000K 1200Lm/m 14,5W/m 12V
5051-13	2.3	3.3	100	LED INTEGRADO 4000K 1200Lm 14,5W 12V
5051-14	2.3	3.3	150	LED INTEGRADO 4000K 1800Lm 22W 12V
5051-15	2.3	3.3	200	LED INTEGRADO 4000K 2400Lm 29W 12V
5051-16	2.3	3.3	250	LED INTEGRADO 4000K 3000Lm 37W 12V
5051-17	2.3	3.3	300	LED INTEGRADO 4000K 3600Lm 44W 12V

PERFIL LED INTEGRADO ALTA POTÊNCIA

	L	H	C	
5051-18	2.3	3.3	M	LED INTEGRADO 3000K 3120Lm/m 20W/m 24V
5051-19	2.3	3.3	100	LED INTEGRADO 3000K 3120Lm 20W 24V
5051-20	2.3	3.3	150	LED INTEGRADO 3000K 4680Lm 30W 24V
5051-21	2.3	3.3	200	LED INTEGRADO 3000K 6240Lm 40W 24V
5051-22	2.3	3.3	250	LED INTEGRADO 3000K 7800Lm 50W 24V
5051-23	2.3	3.3	300	LED INTEGRADO 3000K 9360Lm 60W 24V
5051-24	2.3	3.3	M	LED INTEGRADO 4000K 3120Lm/m 20W/m 24V
5051-25	2.3	3.3	100	LED INTEGRADO 4000K 3120Lm 20W 24V
5051-26	2.3	3.3	150	LED INTEGRADO 4000K 4680Lm 30W 24V
5051-27	2.3	3.3	200	LED INTEGRADO 4000K 6240Lm 40W 24V
5051-28	2.3	3.3	250	LED INTEGRADO 4000K 7800Lm 50W 24V
5051-29	2.3	3.3	300	LED INTEGRADO 4000K 9360Lm 60W 24V

ACESSÓRIOS

5051-30	KIT 10 TAMPAS BORÉ
5051-31	JUNÇÃO BORÉ TETO TETO
5051-32	JUNÇÃO BORÉ TETO PAREDE



PLAFON

	L	H	C	
2140-00	2.3	3.3	60	
2140-01	2.3	3.3	120	
2140-02	2.3	3.3	170	
2140-03	2.3	3.3	60	LED INTEGRADO 3000K 1870LM 12W 24V
2140-04	2.3	3.3	120	LED INTEGRADO 3000K 3750LM 24W 24V
2140-05	2.3	3.3	170	LED INTEGRADO 3000K 5300LM 34W 24V
2140-06	2.3	3.3	60	LED INTEGRADO 4000K 1870LM 12W 24V
2140-07	2.3	3.3	120	LED INTEGRADO 4000K 3750LM 24W 24V
2140-08	2.3	3.3	170	LED INTEGRADO 4000K 5300LM 34W 24V

PENDENTE

	L	H	C	H MÁX	
1193-00	2.3	3.3	60	150	
1193-01	2.3	3.3	120	150	
1193-02	2.3	3.3	170	150	
1193-03	2.3	3.3	60	150	LED INTEGRADO 3000K 1870LM 12W 24V
1193-04	2.3	3.3	120	150	LED INTEGRADO 3000K 3750LM 24W 24V
1193-05	2.3	3.3	170	150	LED INTEGRADO 3000K 5300LM 34W 24V
1193-06	2.3	3.3	60	150	LED INTEGRADO 4000K 1870LM 12W 24V
1193-07	2.3	3.3	120	150	LED INTEGRADO 4000K 3750LM 24W 24V
1193-08	2.3	3.3	170	150	LED INTEGRADO 4000K 5300LM 34W 24V

FIT

SOBREPOR

PERFIL EM ALUMÍNIO COM ACABAMENTO EM PINTURA ELETROSTÁTICA E DIFUSOR EM POLICARBONATO.

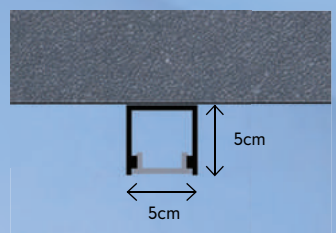

FORNTE NÃO INCLUSA

PREVER ALOJAMENTO PARA FONTE REMOTA

MEDIDAS EM CENTÍMETROS

PERFIL

	L	H	C
5036-00	5	5	M
5036-01	5	5	100
5036-02	5	5	150
5036-03	5	5	200
5036-04	5	5	250
5036-05	5	5	300

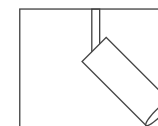

SPOT PARA PERFIL

	L	H	C	LÂMPADAS
4191	4	12	4	1xMINIDICRÓICA
4192	6	12	6	1xDICRÓICA
4193	7,5	12	7,5	1xAR70

PERFIL LED INTEGRADO BAIXA POTÊNCIA

	L	H	C	
5036-06	5	5	M	LED INTEGRADO 2700K 1200LM/M 14,5W/M 12V
5036-07	5	5	100	LED INTEGRADO 2700K 1200LM 14,5W 12V
5036-08	5	5	150	LED INTEGRADO 2700K 1800LM 22W 12V
5036-09	5	5	200	LED INTEGRADO 2700K 2400LM 29W 12V
5036-10	5	5	250	LED INTEGRADO 2700K 3000LM 37W 12V
5036-11	5	5	300	LED INTEGRADO 2700K 3600LM 44W 12V
5036-12	5	5	M	LED INTEGRADO 4000K 1200LM/M 14,5W/M 12V
5036-13	5	5	100	LED INTEGRADO 4000K 1200LM 14,5W 12V
5036-14	5	5	150	LED INTEGRADO 4000K 1800LM 22W 12V
5036-15	5	5	200	LED INTEGRADO 4000K 2400LM 29W 12V
5036-16	5	5	250	LED INTEGRADO 4000K 3000LM 37W 12V
5036-17	5	5	300	LED INTEGRADO 4000K 3600LM 44W 12V

PERFIL LED INTEGRADO ALTA POTÊNCIA

	L	H	C	
5036-18	5	5	M	LED INTEGRADO 3000K 3120LM/M 20W/M 24V
5036-19	5	5	100	LED INTEGRADO 3000K 3120LM 20W 24V
5036-20	5	5	150	LED INTEGRADO 3000K 4680LM 30W 24V
5036-21	5	5	200	LED INTEGRADO 3000K 6240LM 40W 24V
5036-22	5	5	250	LED INTEGRADO 3000K 7800LM 50W 24V
5036-23	5	5	300	LED INTEGRADO 3000K 9360LM 60W 24V
5036-24	5	5	M	LED INTEGRADO 4000K 3120LM/M 20W/M 24V
5036-25	5	5	100	LED INTEGRADO 4000K 3120LM 20W 24V
5036-26	5	5	150	LED INTEGRADO 4000K 4680LM 30W 24V
5036-27	5	5	200	LED INTEGRADO 4000K 6240LM 40W 24V
5036-28	5	5	250	LED INTEGRADO 4000K 7800LM 50W 24V
5036-29	5	5	300	LED INTEGRADO 4000K 9360LM 60W 24V

ACESSÓRIOS

5036-30	KIT 10 TAMPAS FIT SOBREPOR
5036-31	JUNÇÃO FIT SOBREPOR TETO TETO
5036-32	JUNÇÃO FIT SOBREPOR TETO PAREDE

OUTRAS MEDIDAS SOB CONSULTA

ARANDELA

	L	H	C	
3150-00	5	5	65	2xTUBOLED 60cm
3150-01	5	5	125	2xTUBOLED 120cm
3150-02	5	5	60	LED INTEGRADO 2700K 720LM 9W 12V
3150-03	5	5	120	LED INTEGRADO 2700K 1440LM 18W 12V
3150-04	5	5	170	LED INTEGRADO 2700K 2040LM 25W 12V
3150-05	5	5	60	LED INTEGRADO 3000K 720LM 9W 12V
3150-06	5	5	120	LED INTEGRADO 3000K 1440LM 18W 12V
3150-07	5	5	170	LED INTEGRADO 3000K 2040LM 25W 12V

PLAFON

	L	H	C	
2136-00	5	5	65	2xTUBOLED 60cm
2136-01	5	5	125	2xTUBOLED 120cm
2136-02	5	5	60	LED INTEGRADO 3000K 1870LM 12W 24V
2136-03	5	5	120	LED INTEGRADO 3000K 3750LM 24W 24V
2136-04	5	5	170	LED INTEGRADO 3000K 5300LM 34W 24V
2136-05	5	5	60	LED INTEGRADO 4000K 1870LM 12W 24V
2136-06	5	5	120	LED INTEGRADO 4000K 3750LM 24W 24V
2136-07	5	5	170	LED INTEGRADO 4000K 5300LM 34W 24V

PENDENTE

	L	H	C	H MÁX	
1189-00	5	5	65	150	2xTUBOLED 60cm
1189-01	5	5	125	150	2xTUBOLED 120cm
1189-02	5	5	60	150	LED INTEGRADO 3000K 1870LM 12W 24V
1189-03	5	5	120	150	LED INTEGRADO 3000K 3750LM 24W 24V
1189-04	5	5	170	150	LED INTEGRADO 3000K 5300LM 34W 24V
1189-05	5	5	60	150	LED INTEGRADO 4000K 1870LM 12W 24V
1189-06	5	5	120	150	LED INTEGRADO 4000K 3750LM 24W 24V
1189-07	5	5	170	150	LED INTEGRADO 4000K 5300LM 34W 24V



Projeto: @zezinhoeturibio

Fotos: @paulohgornunes



Projeto: @zezinhoeturibio

FIT

EMBUTIR

PERFIL EM ALUMÍNIO COM ACABAMENTO EM PINTURA ELETROSTÁTICA E DIFUSOR EM POLICARBONATO.

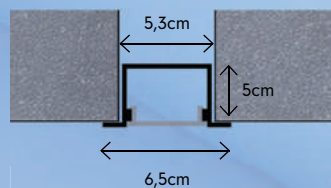

FONTE NÃO INCLUSA

PREVER ALOJAMENTO PARA FONTE REMOTA

MEDIDAS EM CENTÍMETROS

PERFIL

	L	H	C
5038-00	6.5	5	M
5038-01	6.5	5	100
5038-02	6.5	5	150
5038-03	6.5	5	200
5038-04	6.5	5	250
5038-05	6.5	5	300

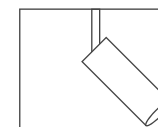

SPOT PARA PERFIL

	L	H	C	LÂMPADAS
4191	4	12	4	1xMINIDICRÓICA
4192	6	12	6	1xDICRÓICA
4193	7,5	12	7,5	1xAR70

PERFIL LED INTEGRADO BAIXA POTÊNCIA

	L	H	C	
5038-06	6.5	5	M	LED INTEGRADO 2700K 1200LM/M 14,5W/M 12V
5038-07	6.5	5	100	LED INTEGRADO 2700K 1200LM 14,5W 12V
5038-08	6.5	5	150	LED INTEGRADO 2700K 1800LM 22W 12V
5038-09	6.5	5	200	LED INTEGRADO 2700K 2400LM 29W 12V
5038-10	6.5	5	250	LED INTEGRADO 2700K 3000LM 37W 12V
5038-11	6.5	5	300	LED INTEGRADO 2700K 3600LM 44W 12V
5038-12	6.5	5	M	LED INTEGRADO 4000K 1200LM/M 14,5W/M 12V
5038-13	6.5	5	100	LED INTEGRADO 4000K 1200LM 14,5W 12V
5038-14	6.5	5	150	LED INTEGRADO 4000K 1800LM 22W 12V
5038-15	6.5	5	200	LED INTEGRADO 4000K 2400LM 29W 12V
5038-16	6.5	5	250	LED INTEGRADO 4000K 3000LM 37W 12V
5038-17	6.5	5	300	LED INTEGRADO 4000K 3600LM 44W 12V

PERFIL LED INTEGRADO ALTA POTÊNCIA

	L	H	C	
5038-18	6.5	5	M	LED INTEGRADO 3000K 3120LM/M 20W/M 24V
5038-19	6.5	5	100	LED INTEGRADO 3000K 3120LM 20W 24V
5038-20	6.5	5	150	LED INTEGRADO 3000K 4680LM 30W 24V
5038-21	6.5	5	200	LED INTEGRADO 3000K 6240LM 40W 24V
5038-22	6.5	5	250	LED INTEGRADO 3000K 7800LM 50W 24V
5038-23	6.5	5	300	LED INTEGRADO 3000K 9360LM 60W 24V
5038-24	6.5	5	M	LED INTEGRADO 4000K 3120LM/M 20W/M 24V
5038-25	6.5	5	100	LED INTEGRADO 4000K 3120LM 20W 24V
5038-26	6.5	5	150	LED INTEGRADO 4000K 4680LM 30W 24V
5038-27	6.5	5	200	LED INTEGRADO 4000K 6240LM 40W 24V
5038-28	6.5	5	250	LED INTEGRADO 4000K 7800LM 50W 24V
5038-29	6.5	5	300	LED INTEGRADO 4000K 9360LM 60W 24V

ACESSÓRIOS

5038-30	KIT 10 TAMPAS FIT EMBUTIR
5038-31	JUNÇÃO FIT EMBUTIR TETO TETO
5038-32	JUNÇÃO FIT EMBUTIR TETO PAREDE

OUTRAS MEDIDAS SOB CONSULTA

CLOSE

PERFIL EM ALUMÍNIO COM ACABAMENTO EM PINTURA ELETROSTÁTICA E DIFUSOR EM POLICARBONATO.

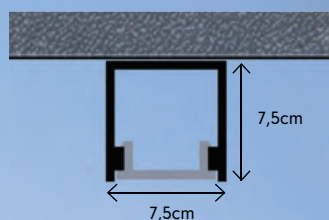

FONTE NÃO INCLUSA

PREVER ALOJAMENTO PARA FONTE REMOTA

MEDIDAS EM CENTÍMETROS

PERFIL

	L	H	C
5035-00	7.5	7.5	M
5035-01	7.5	7.5	100
5035-02	7.5	7.5	150
5035-03	7.5	7.5	200
5035-04	7.5	7.5	250
5035-05	7.5	7.5	300

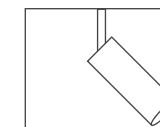

SPOT PARA PERFIL

	L	H	C	LÂMPADAS
4191	4	12	4	1xMINIDICRÓICA
4192	6	12	6	1xDICRÓICA
4193	7,5	12	7,5	1xAR70

PERFIL LED INTEGRADO BAIXA POTÊNCIA

	L	H	C	
5035-06	7.5	7.5	M	LED INTEGRADO 2700K 1200Lm/M 14,5W/M 12V
5035-07	7.5	7.5	100	LED INTEGRADO 2700K 1200Lm 14,5W 12V
5035-08	7.5	7.5	150	LED INTEGRADO 2700K 1800Lm 22W 12V
5035-09	7.5	7.5	200	LED INTEGRADO 2700K 2400Lm 29W 12V
5035-10	7.5	7.5	250	LED INTEGRADO 2700K 3000Lm 37W 12V
5035-11	7.5	7.5	300	LED INTEGRADO 2700K 3600Lm 44W 12V
5035-12	7.5	7.5	M	LED INTEGRADO 4000K 1200Lm/M 14,5W/M 12V
5035-13	7.5	7.5	100	LED INTEGRADO 4000K 1200Lm 14,5W 12V
5035-14	7.5	7.5	150	LED INTEGRADO 4000K 1800Lm 22W 12V
5035-15	7.5	7.5	200	LED INTEGRADO 4000K 2400Lm 29W 12V
5035-16	7.5	7.5	250	LED INTEGRADO 4000K 3000Lm 37W 12V
5035-17	7.5	7.5	300	LED INTEGRADO 4000K 3600Lm 44W 12V

PERFIL LED INTEGRADO ALTA POTÊNCIA

	L	H	C	
5035-18	7.5	7.5	M	LED INTEGRADO 3000K 3120Lm/M 20W/M 24V
5035-19	7.5	7.5	100	LED INTEGRADO 3000K 3120Lm 20W 24V
5035-20	7.5	7.5	150	LED INTEGRADO 3000K 4680Lm 30W 24V
5035-21	7.5	7.5	200	LED INTEGRADO 3000K 6240Lm 40W 24V
5035-22	7.5	7.5	250	LED INTEGRADO 3000K 7800Lm 50W 24V
5035-23	7.5	7.5	300	LED INTEGRADO 3000K 9360Lm 60W 24V
5035-24	7.5	7.5	M	LED INTEGRADO 4000K 3120Lm/M 20W/M 24V
5035-25	7.5	7.5	100	LED INTEGRADO 4000K 3120Lm 20W 24V
5035-26	7.5	7.5	150	LED INTEGRADO 4000K 4680Lm 30W 24V
5035-27	7.5	7.5	200	LED INTEGRADO 4000K 6240Lm 40W 24V
5035-28	7.5	7.5	250	LED INTEGRADO 4000K 7800Lm 50W 24V
5035-29	7.5	7.5	300	LED INTEGRADO 4000K 9360Lm 60W 24V

ACESSÓRIOS

5035-30	KIT 10 TAMPAS CLOSE
5035-31	JUNÇÃO CLOSE TETO TETO
5035-32	JUNÇÃO CLOSE TETO PAREDE

PERFIS

METRO NO FRAME

PERFIL EM ALUMÍNIO COM ACABAMENTO EM PINTURA ELETROSTÁTICA E DIFUSOR EM POLICARBONATO.

FONTE NÃO INCLUSA

PREVER ALOJAMENTO PARA FONTE REMOTA

MEDIDAS EM CENTÍMETROS

PERFIL

	L	H	C
5025-00	12	5	M
5025-01	12	5	100
5025-02	12	5	150
5025-03	12	5	200
5025-04	12	5	250
5025-05	12	5	300

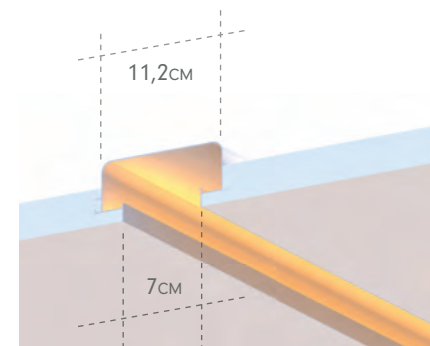

PERFIL LED INTEGRADO

	L	H	C	
5025-06	12	5	M	LED INTEGRADO 2700K 2400Lm/M 29W/M 12V
5025-07	12	5	100	LED INTEGRADO 2700K 2400Lm 29W 12V
5025-08	12	5	150	LED INTEGRADO 2700K 3600Lm 44W 12V
5025-09	12	5	200	LED INTEGRADO 2700K 4800Lm 58W 12V
5025-10	12	5	250	LED INTEGRADO 2700K 6000Lm 72W 12V
5025-11	12	5	300	LED INTEGRADO 2700K 7200Lm 78W 12V
5025-12	12	5	M	LED INTEGRADO 4000K 2400Lm/M 29W/M 12V
5025-13	12	5	100	LED INTEGRADO 4000K 2400Lm 29W 12V
5025-14	12	5	150	LED INTEGRADO 4000K 3600Lm 44W 12V
5025-15	12	5	200	LED INTEGRADO 4000K 4800Lm 58W 12V
5025-16	12	5	250	LED INTEGRADO 4000K 6000Lm 72W 12V
5025-17	12	5	300	LED INTEGRADO 4000K 7200Lm 78W 12V

ACESSÓRIOS

5025-18	KIT 10 TAMPAS METRO NO FRAME
5025-19	JUNÇÃO METRO NO FRAME TETO TETO
5025-20	JUNÇÃO METRO NO FRAME TETO PAREDE

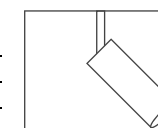

PLAFON PARA METRO NO FRAME

	L	H	C	LÂMPADAS
□ 5025-21	6	12	6	1xMINIDICRÓICA
□ 5025-22	6	12	6	1xDICRÓICA
○ 5025-23	6	12	6	1xMINIDICRÓICA
○ 5025-24	6	12	6	1xDICRÓICA

SPOT PARA PERFIL NO FRAME

	L	H	C	LÂMPADAS
4188	4	12	4	1xMINIDICRÓICA
4189	6	12	6	1xDICRÓICA
4190	7,5	12	7,5	1xAR70

SLIM NO FRAME

PERFIL EM ALUMÍNIO COM ACABAMENTO EM PINTURA
ELETROSTÁTICA E DIFUSOR EM POLICARBONATO

FONTE NÃO INCLUSA

PREVER ALOJAMENTO PARA FONTE REMOTA

MEDIDAS EM CENTÍMETROS

PERFIL

	L	H	C
5029-00	7	5	M
5029-01	7	5	100
5029-02	7	5	150
5029-03	7	5	200
5029-04	7	5	250
5029-05	7	5	300

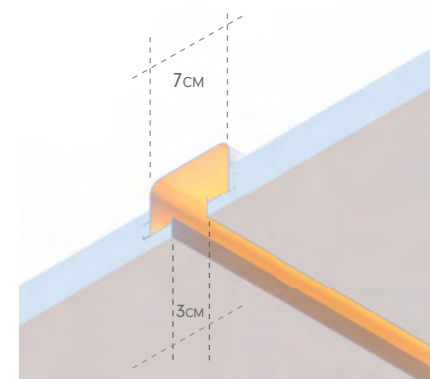

PERFIL LED INTEGRADO

	L	H	C	
5029-06	7	5	M	LED INTEGRADO 2700K 2400Lm/M 29W/M 12V
5029-07	7	5	100	LED INTEGRADO 2700K 2400Lm 29W 12V
5029-08	7	5	150	LED INTEGRADO 2700K 3600Lm 44W 12V
5029-09	7	5	200	LED INTEGRADO 2700K 4800Lm 58W 12V
5029-10	7	5	250	LED INTEGRADO 2700K 6000Lm 72W 12V
5029-11	7	5	300	LED INTEGRADO 2700K 7200Lm 78W 12V
5029-12	7	5	M	LED INTEGRADO 4000K 2400Lm/M 29W/M 12V
5029-13	7	5	100	LED INTEGRADO 4000K 2400Lm 29W 12V
5029-14	7	5	150	LED INTEGRADO 4000K 3600Lm 44W 12V
5029-15	7	5	200	LED INTEGRADO 4000K 4800Lm 58W 12V
5029-16	7	5	250	LED INTEGRADO 4000K 6000Lm 72W 12V
5029-17	7	5	300	LED INTEGRADO 4000K 7200Lm 78W 12V

ACESSÓRIOS

5029-18	KIT 10 TAMPAS SLIM NO FRAME
5029-19	JUNÇÃO SLIM NO FRAME TETO TETO
5029-20	JUNÇÃO SLIM NO FRAME TETO PAREDE

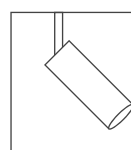

SPOT PARA PERFIL NO FRAME

	L	H	C	LÂMPADAS
4188	4	12	4	1xMINIDICRÓICA
4189	6	12	6	1xDICRÓICA
4190	7,5	12	7,5	1xAR70

METRO

PERFIL EM ALUMÍNIO COM ACABAMENTO EM PINTURA
ELETROSTÁTICA E DIFUSOR EM POLICARBONATO

FONTE NÃO INCLUSA
MEDIDAS EM CENTÍMETROS



PERFIL LUZ DIRETA

	L	H	C
5015	10	5	M
5054-00	10	5	100
5054-01	10	5	150
5054-02	10	5	200
5054-03	10	5	250
5054-04	10	5	300

PERFIL LUZ DIRETA LED INTEGRADO BAIXA POTÊNCIA

	L	H	C	
5015FL	10	5	M	LED INTEGRADO 2700K 2400LM/M 29W/M 12V
5054-05	10	5	100	LED INTEGRADO 2700K 2400LM 29W 12V
5054-06	10	5	150	LED INTEGRADO 2700K 3600LM 44W 12V
5054-07	10	5	200	LED INTEGRADO 2700K 4800LM 58W 12V
5054-08	10	5	250	LED INTEGRADO 2700K 6000LM 72W 12V
5054-09	10	5	300	LED INTEGRADO 2700K 7200LM 87W 12V
5054-10	10	5	M	LED INTEGRADO 4000K 2400LM/M 29W/M 12V
5054-11	10	5	100	LED INTEGRADO 4000K 2400LM 29W 12V
5054-12	10	5	150	LED INTEGRADO 4000K 3600LM 44W 12V
5054-13	10	5	200	LED INTEGRADO 4000K 4800LM 58W 12V
5054-14	10	5	250	LED INTEGRADO 4000K 6000LM 72W 12V
5054-15	10	5	300	LED INTEGRADO 4000K 7200LM 87W 12V

PENDENTE LUZ DIRETA

	L	H	C	H MAX	
1200-00	10	5	65	150	2xTUBOLED 60cm
1200-01	10	5	125	150	2xTUBOLED 120cm
1200-02	10	5	60	150	LED INTEGRADO 3000K 1875LM 12W 12V
1200-03	10	5	120	150	LED INTEGRADO 3000K 3750LM 24W 12V
1200-04	10	5	170	150	LED INTEGRADO 3000K 5300LM 34W 12V
1200-05	10	5	60	150	LED INTEGRADO 4000K 1875LM 12W 12V
1200-06	10	5	120	150	LED INTEGRADO 4000K 3750LM 24W 12V
1200-07	10	5	170	150	LED INTEGRADO 4000K 5300LM 34W 12V

ACESSÓRIOS

	L	H	C	LÂMPADAS
5017	10	5	15	1xAR70
5016	10	5	15	1xDICRÓICA
4197	38	15		1xMINIDICRÓICA

ACESSÓRIOS

	L	H	C
5010	15	5	15
5009	15	5	15
5008	10	5	10

PERFIL LUZ INDIRETA

	L	H	C
5014	10	5	M
5054-28	10	5	100
5054-29	10	5	150
5054-30	10	5	200
5054-31	10	5	250
5054-32	10	5	300

PERFIL LUZ INDIRETA LED INTEGRADO BAIXA POTÊNCIA

	L	H	C	
5014FL	10	5	M	LED INTEGRADO 2700K 2400LM/M 29W/M 12V
5054-33	10	5	100	LED INTEGRADO 2700K 2400LM 29W 12V
5054-34	10	5	150	LED INTEGRADO 2700K 3600LM 44W 12V
5054-35	10	5	200	LED INTEGRADO 2700K 4800LM 58W 12V
5054-36	10	5	250	LED INTEGRADO 2700K 6000LM 72W 12V
5054-37	10	5	300	LED INTEGRADO 2700K 7200LM 87W 12V
5054-38	10	5	M	LED INTEGRADO 4000K 2400LM/M 29W/M 12V
5054-39	10	5	100	LED INTEGRADO 4000K 2400LM 29W 12V
5054-40	10	5	150	LED INTEGRADO 4000K 3600LM 44W 12V
5054-41	10	5	200	LED INTEGRADO 4000K 4800LM 58W 12V
5054-42	10	5	250	LED INTEGRADO 4000K 6000LM 72W 12V
5054-43	10	5	300	LED INTEGRADO 4000K 7200LM 87W 12V

PENDENTE LUZ INDIRETA

	L	H	C	H MAX	
1207-00	10	5	65	50	2xTUBOLED 60cm
1207-01	10	5	125	50	2xTUBOLED 120cm
1207-02	10	5	60	50	LED INTEGRADO 3000K 1875LM 12W 12V
1207-03	10	5	120	50	LED INTEGRADO 3000K 3750LM 24W 12V
1207-04	10	5	170	50	LED INTEGRADO 3000K 5300LM 34W 12V
1207-05	10	5	60	50	LED INTEGRADO 4000K 1875LM 12W 12V
1207-06	10	5	120	50	LED INTEGRADO 4000K 3750LM 24W 12V
1207-07	10	5	170	50	LED INTEGRADO 4000K 5300LM 34W 12V

PERFIL LUZ INDIRETA LED INTEGRADO ALTA POTÊNCIA

	L	H	C	
5054-44	10	5	M	LED INTEGRADO 3000K 3120LM/M 20W/M 24V
5054-45	10	5	100	LED INTEGRADO 3000K 3120LM 20W 24V
5054-46	10	5	150	LED INTEGRADO 3000K 4680LM 30W 24V
5054-47	10	5	200	LED INTEGRADO 3000K 6240LM 40W 24V
5054-48	10	5	250	LED INTEGRADO 3000K 7800LM 50W 24V
5054-49	10	5	300	LED INTEGRADO 3000K 9360LM 60W 24V
5054-50	10	5	M	LED INTEGRADO 4000K 3120LM/M 20W/M 24V
5054-51	10	5	100	LED INTEGRADO 4000K 3120LM 20W 24V
5054-52	10	5	150	LED INTEGRADO 4000K 4680LM 30W 24V
5054-53	10	5	200	LED INTEGRADO 4000K 6240LM 40W 24V
5054-54	10	5	250	LED INTEGRADO 4000K 7800LM 50W 24V
5054-55	10	5	300	LED INTEGRADO 4000K 9360LM 60W 24V

ARANDELA LUZ DIRETA

	L	H	C	
3062	10	5	65	2xTUBOLED 60cm
3063	10	5	125	2xTUBOLED 120cm
3062-01	10	5	60	LED INTEGRADO 2700K 720LM 9W 12V
3063-01	10	5	120	LED INTEGRADO 2700K 1440LM 18W 12V
3062-01	10	5	60	LED INTEGRADO 3000K 720LM 9W 12V
3063-01	10	5	120	LED INTEGRADO 3000K 1440LM 18W 12V

TUPÃ

LUMINÁRIA EM ALUMÍNIO COM ACABAMENTO EM PINTURA
ELETROSTÁTICA E DIFUSOR EM POLICARBONATO

LUZ DIRETA E INDIRETA
FONTE NÃO INCLUSA
PREVER ALOJAMENTO PARA FONTE REMOTA
MEDIDAS EM CENTÍMETROS

PENDENTE

	L	H	C		
1194-00	2.5	5	60	150	
1194-01	2.5	5	120	150	
1194-02	2.5	5	170	150	
1194-03	2.5	5	60	150	LED INTEGRADO 3000K 1870Lm 12W 24V
1194-04	2.5	5	120	150	LED INTEGRADO 3000K 3750Lm 24W 24V
1194-05	2.5	5	170	150	LED INTEGRADO 3000K 5300Lm 34W 24V
1194-06	2.5	5	60	150	LED INTEGRADO 4000K 1870Lm 12W 24V
1194-07	2.5	5	120	150	LED INTEGRADO 4000K 3750Lm 24W 24V
1194-08	2.5	5	170	150	LED INTEGRADO 4000K 5300Lm 34W 24V

PERFIL

	L	H	C
5053-00	2.5	8	M
5053-01	2.5	8	100
5053-02	2.5	8	150
5053-03	2.5	8	200
5053-04	2.5	8	250
5053-05	2.5	8	300

PERFIL LED INTEGRADO BAIXA POTÊNCIA

	L	H	C	
5053-06	2.5	8	M	LED INTEGRADO 2700K 1200Lm/m 14,5W/m 12V
5053-07	2.5	8	100	LED INTEGRADO 2700K 1200Lm 14,5W 12V
5053-08	2.5	8	150	LED INTEGRADO 2700K 1800Lm 22W 12V
5053-09	2.5	8	200	LED INTEGRADO 2700K 2400Lm 29W 12V
5053-10	2.5	8	250	LED INTEGRADO 2700K 3000Lm 37W 12V
5053-11	2.5	8	300	LED INTEGRADO 2700K 3600Lm 44W 12V
5053-12	2.5	8	M	LED INTEGRADO 4000K 1200Lm/m 14,5W/m 12V
5053-13	2.5	8	100	LED INTEGRADO 4000K 1200Lm 14,5W 12V
5053-14	2.5	8	150	LED INTEGRADO 4000K 1800Lm 22W 12V
5053-15	2.5	8	200	LED INTEGRADO 4000K 2400Lm 29W 12V
5053-16	2.5	8	250	LED INTEGRADO 4000K 3000Lm 37W 12V
5053-17	2.5	8	300	LED INTEGRADO 4000K 3600Lm 44W 12V

PERFIL LED INTEGRADO ALTA POTÊNCIA

	L	H	C	
5053-18	2.5	8	M	LED INTEGRADO 3000K 3120Lm/m 20W/m 24V
5053-19	2.5	8	100	LED INTEGRADO 3000K 3120Lm 20W 24V
5053-20	2.5	8	150	LED INTEGRADO 3000K 4680Lm 30W 24V
5053-21	2.5	8	200	LED INTEGRADO 3000K 6240Lm 40W 24V
5053-22	2.5	8	250	LED INTEGRADO 3000K 7800Lm 50W 24V
5053-23	2.5	8	300	LED INTEGRADO 3000K 9360Lm 60W 24V
5053-24	2.5	8	M	LED INTEGRADO 4000K 3120Lm/m 20W/m 24V
5053-25	2.5	8	100	LED INTEGRADO 4000K 3120Lm 20W 24V
5053-26	2.5	8	150	LED INTEGRADO 4000K 4680Lm 30W 24V
5053-27	2.5	8	200	LED INTEGRADO 4000K 6240Lm 40W 24V
5053-28	2.5	8	250	LED INTEGRADO 4000K 7800Lm 50W 24V
5053-29	2.5	8	300	LED INTEGRADO 4000K 9360Lm 60W 24V

ACESSÓRIOS

5053-30	KIT 10 TAMPAS TUPÃ
5053-31	JUNÇÃO TUPÃ TETO TETO
5053-32	JUNÇÃO TUPÃ TETO PAREDE

OUTRAS MEDIDAS SOB CONSULTA

ARANDELA

	L	H	C	
3149-00	7.5	7.5	65	2xTUBOLED 60cm
3149-01	7.5	7.5	125	2xTUBOLED 120cm
3149-02	7.5	7.5	60	LED INTEGRADO 2700K 720Lm 9W 12V
3149-03	7.5	7.5	120	LED INTEGRADO 2700K 1440Lm 18W 12V
3149-04	7.5	7.5	170	LED INTEGRADO 2700K 2040Lm 25W 12V
3149-05	7.5	7.5	60	LED INTEGRADO 3000K 720Lm 9W 12V
3149-06	7.5	7.5	120	LED INTEGRADO 3000K 1440Lm 18W 12V
3149-07	7.5	7.5	170	LED INTEGRADO 3000K 2040Lm 25W 12V

PLAFON

	L	H	C	
2135-00	7.5	7.5	65	2xTUBOLED 60cm
2135-01	7.5	7.5	125	2xTUBOLED 120cm
2135-02	7.5	7.5	60	LED INTEGRADO 3000K 1870Lm 12W 24V
2135-03	7.5	7.5	120	LED INTEGRADO 3000K 3750Lm 24W 24V
2135-04	7.5	7.5	170	LED INTEGRADO 3000K 5300Lm 34W 24V
2135-05	7.5	7.5	60	LED INTEGRADO 4000K 1870Lm 12W 24V
2135-06	7.5	7.5	120	LED INTEGRADO 4000K 3750Lm 24W 24V
2135-07	7.5	7.5	170	LED INTEGRADO 4000K 5300Lm 34W 24V

PENDENTE

	L	H	C	H MÁX	
1183-00	7.5	7.5	65	150	2xTUBOLED 60cm
1183-01	7.5	7.5	125	150	2xTUBOLED 120cm
1183-02	7.5	7.5	170	150	4xTUBOLED 120cm
1183-03	7.5	7.5	60	150	LED INTEGRADO 3000K 1870Lm 12W 24V
1183-04	7.5	7.5	120	150	LED INTEGRADO 3000K 3750Lm 24W 24V
1183-05	7.5	7.5	170	150	LED INTEGRADO 3000K 5300Lm 34W 24V
1183-06	7.5	7.5	60	150	LED INTEGRADO 4000K 1870Lm 12W 24V
1183-07	7.5	7.5	120	150	LED INTEGRADO 4000K 3750Lm 24W 24V
1183-08	7.5	7.5	170	150	LED INTEGRADO 4000K 5300Lm 34W 24V

OUTRAS MEDIDAS SOB CONSULTA

CANOA

LUMINÁRIA EM ALUMÍNIO COM ACABAMENTO EM PINTURA
ELETROSTÁTICA E DIFUSOR EM POLICARBONATO

LUZ DIRETA
FONTE NÃO INCLUSA
PREVER ALOJAMENTO PARA FONTE REMOTA
MEDIDAS EM CENTÍMETROS

PENDENTE

	L	H	C
1195-00	5	5	60
1195-01	5	5	120
1195-02	5	5	170

PENDENTE LED INTEGRADO

	L	H	C	
1195-03	5	5	60	LED INTEGRADO 3000K 1870Lm 12W 24V
1195-04	5	5	120	LED INTEGRADO 3000K 3750Lm 24W 24V
1195-05	5	5	170	LED INTEGRADO 3000K 5300Lm 34W 24V
1195-06	5	5	60	LED INTEGRADO 4000K 1870Lm 12W 24V
1195-07	5	5	120	LED INTEGRADO 4000K 3750Lm 24W 24V
1195-08	5	5	170	LED INTEGRADO 4000K 5300Lm 34W 24V

FRAMES

LUMINÁRIA EM ALUMÍNIO COM ACABAMENTO EM PINTURA
ELETRÓSTÁTICA E DIFUSOR EM POLICARBONATO

FONTE NÃO INCLUSA

PREVER ALOJAMENTO PARA FONTE REMOTA

MEDIDAS EM CENTÍMETROS



ARANDELA LUZ DIRETA H=5

	C	L	H
3155-00	30	30	5
3155-01	40	40	5
3155-02	50	50	5
3155-03	30	60	5
3155-04	30	90	5
3155-05	30	120	5

ARANDELA LUZ INDIRETA H=5

	C	L	H
3155-36	30	30	5
3155-37	40	40	5
3155-38	50	50	5
3155-39	30	60	5
3155-40	30	90	5
3155-41	30	120	5

ARANDELA LUZ DIRETA H=9

	C	L	H
3155-06	30	30	9
3155-07	40	40	9
3155-08	50	50	9
3155-09	30	60	9
3155-10	30	90	9
3155-11	30	120	9

ARANDELA LUZ INDIRETA H=9

	C	L	H
3155-42	30	30	9
3155-43	40	40	9
3155-44	50	50	9
3155-45	30	60	9
3155-46	30	90	9
3155-47	30	120	9

PLAFON LUZ DIRETA H=5

	C	L	H
2141-00	40	40	5
2141-01	50	50	5
2141-02	60	60	5
2141-03	30	60	5
2141-04	30	90	5
2141-05	30	120	5

PLAFON LUZ INDIRETA H=5

	C	L	H
2141-36	40	40	5
2141-37	50	50	5
2141-38	60	60	5
2141-39	30	60	5
2141-40	30	90	5
2141-41	30	120	5

PLAFON LUZ DIRETA H=9

	C	L	H
2141-06	40	40	9
2141-07	50	50	9
2141-08	60	60	9
2141-09	30	60	9
2141-10	30	90	9
2141-11	30	120	9

PLAFON LUZ INDIRETA H=9

	C	L	H
2141-42	40	40	9
2141-43	50	50	9
2141-44	60	60	9
2141-45	30	60	9
2141-46	30	90	9
2141-47	30	120	9

PENDENTE LUZ DIRETA

	C	L	H	H MAX
1196-00	40	40	5	150
1196-01	50	50	5	150
1196-02	60	60	5	150
1196-03	30	60	5	150
1196-04	30	90	5	150
1196-05	30	120	5	150

PENDENTE LUZ INDIRETA

	C	L	H	H MAX
1196-18	40	40	5	150
1196-19	50	50	5	150
1196-20	60	60	5	150
1196-21	30	60	5	150
1196-22	30	90	5	150
1196-23	30	120	5	150

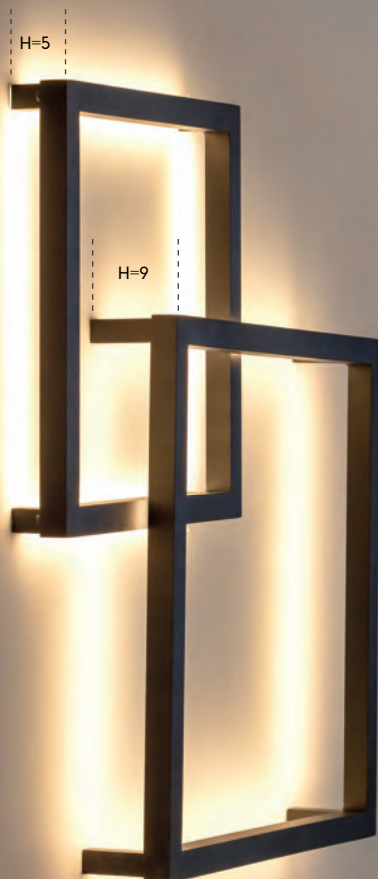

ARANDELA LED INTEGRADO - LUZ DIRETA H=5

	C	L	H	
3155-12	30	30	5	LED INTEGRADO 2700K 1440LM 12V 18W
3155-13	40	40	5	LED INTEGRADO 2700K 1920LM 12V 23W
3155-14	50	50	5	LED INTEGRADO 2700K 2400LM 12V 29W
3155-15	30	60	5	LED INTEGRADO 2700K 2160LM 12V 26W
3155-16	30	90	5	LED INTEGRADO 2700K 2880LM 12V 35W
3155-17	30	120	5	LED INTEGRADO 2700K 3600LM 12V 44W
3155-18	30	30	5	LED INTEGRADO 4000K 1440LM 12V 18W
3155-19	40	40	5	LED INTEGRADO 4000K 1920LM 12V 23W
3155-20	50	50	5	LED INTEGRADO 4000K 2400LM 12V 29W
3155-21	30	60	5	LED INTEGRADO 4000K 2160LM 12V 26W
3155-22	30	90	5	LED INTEGRADO 4000K 2880LM 12V 35W
3155-23	30	120	5	LED INTEGRADO 4000K 3600LM 12V 44W

ARANDELA LED INTEGRADO - LUZ DIRETA H=9

	C	L	H	
3155-24	30	30	9	LED INTEGRADO 2700K 1440LM 12V 18W
3155-25	40	40	9	LED INTEGRADO 2700K 1920LM 12V 23W
3155-26	50	50	9	LED INTEGRADO 2700K 2400LM 12V 29W
3155-27	30	60	9	LED INTEGRADO 2700K 2160LM 12V 26W
3155-28	30	90	9	LED INTEGRADO 2700K 2880LM 12V 35W
3155-29	30	120	9	LED INTEGRADO 2700K 3600LM 12V 44W
3155-30	30	30	9	LED INTEGRADO 4000K 1440LM 12V 18W
3155-31	40	40	9	LED INTEGRADO 4000K 1920LM 12V 23W
3155-32	50	50	9	LED INTEGRADO 4000K 2400LM 12V 29W
3155-33	30	60	9	LED INTEGRADO 4000K 2160LM 12V 26W
3155-34	30	90	9	LED INTEGRADO 4000K 2880LM 12V 35W
3155-35	30	120	9	LED INTEGRADO 4000K 3600LM 12V 44W

ARANDELA LED INTEGRADO - LUZ INDIRETA H=5

	C	L	H	
3155-48	30	30	5	LED INTEGRADO 2700K 1440LM 12V 18W
3155-49	40	40	5	LED INTEGRADO 2700K 1920LM 12V 23W
3155-50	50	50	5	LED INTEGRADO 2700K 2400LM 12V 29W
3155-51	30	60	5	LED INTEGRADO 2700K 2160LM 12V 26W
3155-52	30	90	5	LED INTEGRADO 2700K 2880LM 12V 35W
3155-53	30	120	5	LED INTEGRADO 2700K 3600LM 12V 44W
3155-54	30	30	5	LED INTEGRADO 4000K 1440LM 12V 18W
3155-55	40	40	5	LED INTEGRADO 4000K 1920LM 12V 23W
3155-56	50	50	5	LED INTEGRADO 4000K 2400LM 12V 29W
3155-57	30	60	5	LED INTEGRADO 4000K 2160LM 12V 26W
3155-58	30	90	5	LED INTEGRADO 4000K 2880LM 12V 35W
3155-59	30	120	5	LED INTEGRADO 4000K 3600LM 12V 44W

ARANDELA LED INTEGRADO - LUZ INDIRETA H=9

	C	L	H	
3155-60	30	30	9	LED INTEGRADO 2700K 1440LM 12V 18W
3155-61	40	40	9	LED INTEGRADO 2700K 1920LM 12V 23W
3155-62	50	50	9	LED INTEGRADO 2700K 2400LM 12V 29W
3155-63	30	60	9	LED INTEGRADO 2700K 2160LM 12V 26W
3155-64	30	90	9	LED INTEGRADO 2700K 2880LM 12V 35W
3155-65	30	120	9	LED INTEGRADO 2700K 3600LM 12V 44W
3155-66	30	30	9	LED INTEGRADO 4000K 1440LM 12V 18W
3155-67	40	40	9	LED INTEGRADO 4000K 1920LM 12V 23W
3155-68	50	50	9	LED INTEGRADO 4000K 2400LM 12V 29W
3155-69	30	60	9	LED INTEGRADO 4000K 2160LM 12V 26W
3155-70	30	90	9	LED INTEGRADO 4000K 2880LM 12V 35W
3155-71	30	120	9	LED INTEGRADO 4000K 3600LM 12V 44W

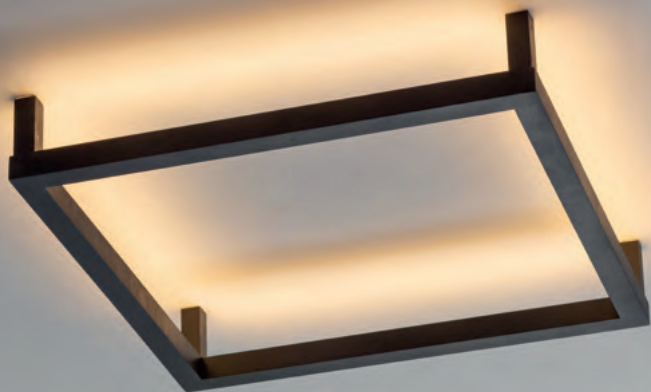

FRAMES

LUMINÁRIA EM ALUMÍNIO COM ACABAMENTO EM PINTURA
ELETROSTÁTICA E DIFUSOR EM POLICARBONATO

FONTE NÃO INCLUSA

PREVER ALOJAMENTO PARA FONTE REMOTA

MEDIDAS EM CENTÍMETROS

PLAFON LED INTEGRADO - LUZ DIRETA H=5

	C	L	H	
2141-12	40	40	5	LED INTEGRADO 3000K 4990LM 12V 32W
2141-13	50	50	5	LED INTEGRADO 3000K 6240LM 12V 40W
2141-14	60	60	5	LED INTEGRADO 3000K 7490LM 12V 48W
2141-15	30	60	5	LED INTEGRADO 3000K 5620LM 12V 36W
2141-16	30	90	5	LED INTEGRADO 3000K 7490LM 12V 48W
2141-17	30	120	5	LED INTEGRADO 3000K 9360LM 12V 60W
2141-18	40	40	5	LED INTEGRADO 4000K 3750LM 12V 24W
2141-19	50	50	5	LED INTEGRADO 4000K 4990LM 12V 32W
2141-20	60	60	5	LED INTEGRADO 4000K 7490LM 12V 48W
2141-21	30	60	5	LED INTEGRADO 4000K 5620LM 12V 36W
2141-22	30	90	5	LED INTEGRADO 4000K 7490LM 12V 48W
2141-23	30	120	5	LED INTEGRADO 4000K 9360LM 12V 60W

PLAFON LED INTEGRADO - LUZ DIRETA H=9

	C	L	H	
2141-24	40	40	9	LED INTEGRADO 3000K 4990LM 12V 32W
2141-25	50	50	9	LED INTEGRADO 3000K 6240LM 12V 40W
2141-26	60	60	9	LED INTEGRADO 3000K 7490LM 12V 48W
2141-27	30	30	9	LED INTEGRADO 3000K 5620LM 12V 36W
2141-28	30	30	9	LED INTEGRADO 3000K 7490LM 12V 48W
2141-29	30	30	9	LED INTEGRADO 3000K 9360LM 12V 60W
2141-30	40	40	9	LED INTEGRADO 4000K 3750LM 12V 24W
2141-31	50	50	9	LED INTEGRADO 4000K 4990LM 12V 32W
2141-32	60	60	9	LED INTEGRADO 4000K 7490LM 12V 48W
2141-33	30	30	9	LED INTEGRADO 4000K 5620LM 12V 36W
2141-34	30	30	9	LED INTEGRADO 4000K 7490LM 12V 48W
2141-35	30	30	9	LED INTEGRADO 4000K 9360LM 12V 60W

PENDENTE LED INTEGRADO - LUZ DIRETA

	C	L	H	H MAX	
1196-06	40	40	5	150	LED INTEGRADO 3000K 4990LM 12V 32W
1196-07	50	50	5	150	LED INTEGRADO 3000K 6240LM 12V 40W
1196-08	60	60	5	150	LED INTEGRADO 3000K 7490LM 12V 48W
1196-09	30	30	5	150	LED INTEGRADO 3000K 5620LM 12V 36W
1196-10	30	30	5	150	LED INTEGRADO 3000K 7490LM 12V 48W
1196-11	30	30	5	150	LED INTEGRADO 3000K 9360LM 12V 60W
1196-12	40	40	5	150	LED INTEGRADO 4000K 3750LM 12V 24W
1196-13	50	50	5	150	LED INTEGRADO 4000K 4990LM 12V 32W
1196-14	60	60	5	150	LED INTEGRADO 4000K 7490LM 12V 48W
1196-15	30	30	5	150	LED INTEGRADO 4000K 5620LM 12V 36W
1196-16	30	30	5	150	LED INTEGRADO 4000K 7490LM 12V 48W
1196-17	30	30	5	150	LED INTEGRADO 4000K 9360LM 12V 60W

PLAFON LED INTEGRADO - LUZ INDIRETA H=5

	C	L	H	
2141-48	40	40	5	LED INTEGRADO 3000K 4990LM 12V 32W
2141-49	50	50	5	LED INTEGRADO 3000K 6240LM 12V 40W
2141-50	60	60	5	LED INTEGRADO 3000K 7490LM 12V 48W
2141-51	30	30	5	LED INTEGRADO 3000K 5620LM 12V 36W
2141-52	30	30	5	LED INTEGRADO 3000K 7490LM 12V 48W
2141-53	30	30	5	LED INTEGRADO 3000K 9360LM 12V 60W
2141-54	40	40	5	LED INTEGRADO 4000K 3750LM 12V 24W
2141-55	50	50	5	LED INTEGRADO 4000K 4990LM 12V 32W
2141-56	60	60	5	LED INTEGRADO 4000K 7490LM 12V 48W
2141-57	30	30	5	LED INTEGRADO 4000K 5620LM 12V 36W
2141-58	30	30	5	LED INTEGRADO 4000K 7490LM 12V 48W
2141-59	30	30	5	LED INTEGRADO 4000K 9360LM 12V 60W

PLAFON LED INTEGRADO - LUZ INDIRETA H=9

	C	L	H	
2141-60	40	40	9	LED INTEGRADO 3000K 4990LM 12V 32W
2141-61	50	50	9	LED INTEGRADO 3000K 6240LM 12V 40W
2141-62	60	60	9	LED INTEGRADO 3000K 7490LM 12V 48W
2141-63	30	30	9	LED INTEGRADO 3000K 5620LM 12V 36W
2141-64	30	30	9	LED INTEGRADO 3000K 7490LM 12V 48W
2141-65	30	30	9	LED INTEGRADO 3000K 9360LM 12V 60W
2141-66	40	40	9	LED INTEGRADO 4000K 3750LM 12V 24W
2141-67	50	50	9	LED INTEGRADO 4000K 4990LM 12V 32W
2141-68	60	60	9	LED INTEGRADO 4000K 7490LM 12V 48W
2141-69	30	30	9	LED INTEGRADO 4000K 5620LM 12V 36W
2141-70	30	30	9	LED INTEGRADO 4000K 7490LM 12V 48W
2141-71	30	30	9	LED INTEGRADO 4000K 9360LM 12V 60W

PENDENTE LED INTEGRADO - LUZ INDIRETA

	C	L	H	H MAX	
1196-24	40	40	5	150	LED INTEGRADO 3000K 4990LM 12V 32W
1196-25	50	50	5	150	LED INTEGRADO 3000K 6240LM 12V 40W
1196-26	60	60	5	150	LED INTEGRADO 3000K 7490LM 12V 48W
1196-27	30	30	5	150	LED INTEGRADO 3000K 5620LM 12V 36W
1196-28	30	30	5	150	LED INTEGRADO 3000K 7490LM 12V 48W
1196-29	30	30	5	150	LED INTEGRADO 3000K 9360LM 12V 60W
1196-30	40	40	5	150	LED INTEGRADO 4000K 3750LM 12V 24W
1196-31	50	50	5	150	LED INTEGRADO 4000K 4990LM 12V 32W
1196-32	60	60	5	150	LED INTEGRADO 4000K 7490LM 12V 48W
1196-33	30	30	5	150	LED INTEGRADO 4000K 5620LM 12V 36W
1196-34	30	30	5	150	LED INTEGRADO 4000K 7490LM 12V 48W
1196-35	30	30	5	150	LED INTEGRADO 4000K 9360LM 12V 60W

FRAMES

LUMINÁRIA DE MESA

	L	H	P	
6020	30	40	9	LED INTEGRADO 2700K 1440LM 12V 18W
6021	30	50	9	LED INTEGRADO 2700K 1920LM 12V 23W



PERFIS

FRAMES

LUMINÁRIA DE CHÃO

	L	H	P	
6022	30	150	9	LED INTEGRADO 2700K 2400LM 12V 29W





TRIAD

LUMINÁRIA EM ALUMÍNIO COM ACABAMENTO EM PINTURA
ELETROSTÁTICA E DIFUSOR EM POLICARBONATO

FONTE NÃO INCLUSA

PREVER ALOJAMENTO PARA FONTE REMOTA

MEDIDAS EM CENTÍMETROS

ARANDELA LUZ DIRETA H=5

	LADO	H
3156-00	35	5
3156-01	43	5
3156-02	52	5
3156-03	60	5

ARANDELA LUZ INDIRETA H=5

	LADO	H
3156-24	35	5
3156-25	43	5
3156-26	52	5
3156-27	60	5

ARANDELA LUZ DIRETA H=9

	LADO	H
3156-04	35	9
3156-05	43	9
3156-06	52	9
3156-07	60	9

ARANDELA LUZ INDIRETA H=9

	LADO	H
3156-28	35	9
3156-29	43	9
3156-30	52	9
3156-31	60	9

PLAFON LUZ DIRETA H=5

	LADO	H
2141-00	35	5
2141-01	43	5
2141-02	52	5
2141-03	60	5

PLAFON LUZ INDIRETA H=5

	LADO	H
2141-24	35	5
2141-29	43	5
2141-30	52	5
2141-31	60	5

PLAFON LUZ DIRETA H=9

	LADO	H
2141-04	35	9
2141-05	43	9
2141-06	52	9
2141-07	60	9

PLAFON LUZ INDIRETA H=9

	LADO	H
2141-32	35	9
2141-33	43	9
2141-34	52	9
2141-35	60	9

PENDENTE LUZ DIRETA

	LADO	H	H MAX
1196-00	35	2.5	150
1196-01	43	2.5	150
1196-02	52	2.5	150
1196-03	60	2.5	150

PENDENTE LUZ INDIRETA

	LADO	H	H MAX
1196-12	35	2.5	150
1196-13	43	2.5	150
1196-14	52	2.5	150
1196-15	60	2.5	150

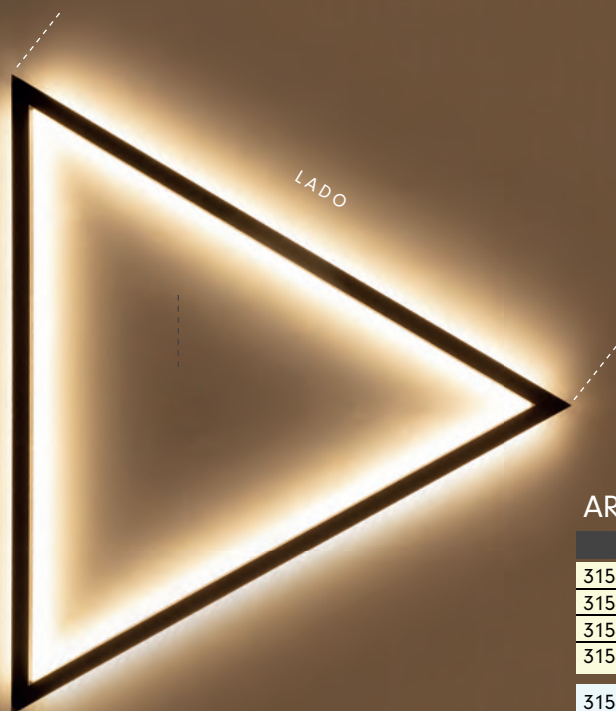

ARANDELA LED INTEGRADO - LUZ DIRETA H=5

	LADO	H	
3156-08	35	5	LED INTEGRADO 2700K 1260LM 12V 16W
3156-09	43	5	LED INTEGRADO 2700K 1550LM 12V 19W
3156-10	52	5	LED INTEGRADO 2700K 1870LM 12V 23W
3156-11	60	5	LED INTEGRADO 2700K 2160LM 12V 26W
3156-12	35	5	LED INTEGRADO 4000K 1260LM 12V 16W
3156-13	43	5	LED INTEGRADO 4000K 1550LM 12V 19W
3156-14	52	5	LED INTEGRADO 4000K 1870LM 12V 23W
3156-15	60	5	LED INTEGRADO 4000K 2160LM 12V 26W

ARANDELA LED INTEGRADO - LUZ DIRETA H=9

	LADO	H	
3156-16	35	9	LED INTEGRADO 2700K 1260LM 12V 16W
3156-17	43	9	LED INTEGRADO 2700K 1550LM 12V 19W
3156-18	52	9	LED INTEGRADO 2700K 1870LM 12V 23W
3156-19	60	9	LED INTEGRADO 2700K 2160LM 12V 26W
3156-20	35	9	LED INTEGRADO 4000K 1260LM 12V 16W
3156-21	43	9	LED INTEGRADO 4000K 1550LM 12V 19W
3156-22	52	9	LED INTEGRADO 4000K 1870LM 12V 23W
3156-23	60	9	LED INTEGRADO 4000K 2160LM 12V 26W

ARANDELA LED INTEGRADO - LUZ INDIRETA H=5

	LADO	H	
3156-32	35	5	LED INTEGRADO 2700K 1260LM 12V 16W
3156-33	43	5	LED INTEGRADO 2700K 1550LM 12V 19W
3156-34	52	5	LED INTEGRADO 2700K 1870LM 12V 23W
3156-35	60	5	LED INTEGRADO 2700K 2160LM 12V 26W
3156-36	35	5	LED INTEGRADO 4000K 1260LM 12V 16W
3156-37	43	5	LED INTEGRADO 4000K 1550LM 12V 19W
3156-38	52	5	LED INTEGRADO 4000K 1870LM 12V 23W
3156-39	60	5	LED INTEGRADO 4000K 2160LM 12V 26W

ARANDELA LED INTEGRADO - LUZ DIRETA H=9

	LADO	H	
3156-40	35	9	LED INTEGRADO 2700K 1260LM 12V 16W
3156-41	43	9	LED INTEGRADO 2700K 1550LM 12V 19W
3156-42	52	9	LED INTEGRADO 2700K 1870LM 12V 23W
3156-43	60	9	LED INTEGRADO 2700K 2160LM 12V 26W
3156-44	35	9	LED INTEGRADO 4000K 1260LM 12V 16W
3156-45	43	9	LED INTEGRADO 4000K 1550LM 12V 19W
3156-46	52	9	LED INTEGRADO 4000K 1870LM 12V 23W
3156-47	60	9	LED INTEGRADO 4000K 2160LM 12V 26W

PERFIS



TRIAD

LUMINÁRIA EM ALUMÍNIO COM ACABAMENTO EM PINTURA
ELETROSTÁTICA E DIFUSOR EM POLICARBONATO

FONTE NÃO INCLUSA

PREVER ALOJAMENTO PARA FONTE REMOTA

MEDIDAS EM CENTÍMETROS

PLAFON LED INTEGRADO - LUZ DIRETA H=5

	LADO	H	
2141-08	35	5	LED INTEGRADO 3000K 1260LM 24V 16W
2141-09	43	5	LED INTEGRADO 3000K 1550LM 24V 19W
2141-10	52	5	LED INTEGRADO 3000K 1870LM 24V 23W
2141-11	60	5	LED INTEGRADO 3000K 2160LM 24V 26W
2141-12	35	5	LED INTEGRADO 4000K 1260LM 24V 16W
2141-13	43	5	LED INTEGRADO 4000K 1550LM 24V 19W
2141-14	52	5	LED INTEGRADO 4000K 1870LM 24V 23W
2141-15	60	5	LED INTEGRADO 4000K 2160LM 24V 26W

PLAFON LED INTEGRADO - LUZ DIRETA H=9

	LADO	H	
2141-16	35	9	LED INTEGRADO 3000K 1260LM 24V 16W
2141-17	43	9	LED INTEGRADO 3000K 1550LM 24V 19W
2141-18	52	9	LED INTEGRADO 3000K 1870LM 24V 23W
2141-19	60	9	LED INTEGRADO 3000K 2160LM 24V 26W
2141-20	35	9	LED INTEGRADO 4000K 1260LM 24V 16W
2141-21	43	9	LED INTEGRADO 4000K 1550LM 24V 19W
2141-22	52	9	LED INTEGRADO 4000K 1870LM 24V 23W
2141-23	60	9	LED INTEGRADO 4000K 2160LM 24V 26W

PENDENTE LED INTEGRADO - LUZ DIRETA

	LADO	H	H MAX	
1196-04	35	2.5	150	LED INTEGRADO 3000K 1260LM 24V 16W
1196-05	43	2.5	150	LED INTEGRADO 3000K 1550LM 24V 19W
1196-06	52	2.5	150	LED INTEGRADO 3000K 1870LM 24V 23W
1196-07	60	2.5	150	LED INTEGRADO 3000K 2160LM 24V 26W
1196-08	35	2.5	150	LED INTEGRADO 4000K 1260LM 24V 16W
1196-09	43	2.5	150	LED INTEGRADO 4000K 1550LM 24V 19W
1196-10	52	2.5	150	LED INTEGRADO 4000K 1870LM 24V 23W
1196-11	60	2.5	150	LED INTEGRADO 4000K 2160LM 24V 26W

PLAFON LED INTEGRADO - LUZ INDIRETA H=5

	LADO	H	
2141-36	35	5	LED INTEGRADO 3000K 3270LM 24V 21W
2141-37	43	5	LED INTEGRADO 3000K 4025LM 24V 26W
2141-38	52	5	LED INTEGRADO 3000K 4870LM 24V 32W
2141-39	60	5	LED INTEGRADO 3000K 5610LM 24V 36W
2141-40	35	5	LED INTEGRADO 4000K 1260LM 24V 16W
2141-41	43	5	LED INTEGRADO 4000K 1550LM 24V 19W
2141-42	52	5	LED INTEGRADO 4000K 1870LM 24V 23W
2141-43	60	5	LED INTEGRADO 4000K 2160LM 24V 26W

PLAFON LED INTEGRADO - LUZ INDIRETA H=9

	LADO	H	
2141-44	35	9	LED INTEGRADO 3000K 1260LM 24V 16W
2141-45	43	9	LED INTEGRADO 3000K 1550LM 24V 19W
2141-46	52	9	LED INTEGRADO 3000K 1870LM 24V 23W
2141-47	60	9	LED INTEGRADO 3000K 2160LM 24V 26W
2141-48	35	9	LED INTEGRADO 4000K 1260LM 24V 16W
2141-49	43	9	LED INTEGRADO 4000K 1550LM 24V 19W
2141-50	52	9	LED INTEGRADO 4000K 1870LM 24V 23W
2141-51	60	9	LED INTEGRADO 4000K 2160LM 24V 26W

PENDENTE LED INTEGRADO - LUZ INDIRETA

	LADO	H	H MAX	
1196-16	35	2.5	150	LED INTEGRADO 3000K 1260LM 24V 16W
1196-17	43	2.5	150	LED INTEGRADO 3000K 1550LM 24V 19W
1196-18	52	2.5	150	LED INTEGRADO 3000K 1870LM 24V 23W
1196-19	60	2.5	150	LED INTEGRADO 3000K 2160LM 24V 26W
1196-20	35	2.5	150	LED INTEGRADO 4000K 1260LM 24V 16W
1196-21	43	2.5	150	LED INTEGRADO 4000K 1550LM 24V 19W
1196-22	52	2.5	150	LED INTEGRADO 4000K 1870LM 24V 23W
1196-23	60	2.5	150	LED INTEGRADO 4000K 2160LM 24V 26W

DOUBLE

PLAFON EM ALUMÍNIO COM
ACABAMENTO EM PINTURA
ELETROSTÁTICA E DIFUSOR
EM POLICARBONATO.

FORNE NÃO INCLUSA

PREVER ALOJAMENTO PARA FONTE REMOTA

MEDIDAS EM CENTÍMETROS

PLAFON LUZ DIRETA E INDIRETA

	C	L	H
2143-00	30	30	5
2143-01	40	40	5
2143-02	50	50	5
2143-03	60	60	5

PLAFON LUZ DIRETA E INDIRETA LED INTEGRADO

	C	L	H	
2143-04	30	30	5	LED INTEGRADO 2700K 7490LM 12V 48W
2143-05	40	40	5	LED INTEGRADO 2700K 9980LM 12V 64W
2143-06	50	50	5	LED INTEGRADO 2700K 12480LM 12V 80W
2143-07	60	60	5	LED INTEGRADO 2700K 14970LM 12V 96W
2143-08	30	30	5	LED INTEGRADO 4000K 7490LM 12V 48W
2143-09	40	40	5	LED INTEGRADO 4000K 9980LM 12V 64W
2143-10	50	50	5	LED INTEGRADO 4000K 12480LM 12V 80W
2143-11	60	60	5	LED INTEGRADO 4000K 14970LM 12V 96W



PARES

LUMINÁRIA EM ALUMÍNIO COM ACABAMENTO EM PINTURA
ELETROSTÁTICA E DIFUSOR EM POLICARBONATO

FONTE NÃO INCLUSA

PREVER ALOJAMENTO PARA FONTE REMOTA

MEDIDAS EM CENTÍMETROS

PLAFON LUZ DIRETA

	L	C	H
2145-01	40	47	9
2145-02	43	83	9
2145-03	55	55	9
2145-04	50	67	9

2145-13	40	47	9	LED INTEGRADO 3000K 5430Lms 24V 35W
2145-14	43	83	9	LED INTEGRADO 3000K 7800Lms 24V 51W
2145-15	55	55	9	LED INTEGRADO 3000K 55X55 6870Lms 24V 44W
2145-16	50	67	9	LED INTEGRADO 3000K 50X67 7300Lms 24V 47W

2145-17	40	47	9	LED INTEGRADO 4000K 5430Lms 24V 35W
2145-18	43	83	9	LED INTEGRADO 4000K 7800Lms 24V 51W
2145-19	55	55	9	LED INTEGRADO 4000K 55X55 6870Lms 24V 44W
2145-20	50	67	9	LED INTEGRADO 4000K 50X67 7300Lms 24V 47W

PLAFON LUZ INDIRETA

	L	C	H
2145-05	40	47	9
2145-06	43	83	9
2145-07	55	55	9
2145-08	50	67	9

2145-13	40	47	9	LED INTEGRADO 3000K 5430Lms 24V 35W
2145-14	43	83	9	LED INTEGRADO 3000K 7800Lms 24V 51W
2145-15	55	55	9	LED INTEGRADO 3000K 55X55 6870Lms 24V 44W
2145-16	50	67	9	LED INTEGRADO 3000K 50X67 7300Lms 24V 47W

2145-17	40	47	9	LED INTEGRADO 4000K 5430Lms 24V 35W
2145-18	43	83	9	LED INTEGRADO 4000K 7800Lms 24V 51W
2145-19	55	55	9	LED INTEGRADO 4000K 55X55 6870Lms 24V 44W
2145-20	50	67	9	LED INTEGRADO 4000K 50X67 7300Lms 24V 47W

PLAFON LUZ DIRETA E INDIRETA

	L	C	H
2145-09	40	47	9
2145-10	43	83	9
2145-11	55	55	9
2145-12	50	67	9

2145-29	40	47	9	LED INTEGRADO 3000K 5430Lms 24V 35W
2145-30	43	83	9	LED INTEGRADO 3000K 7800Lms 24V 51W
2145-31	55	55	9	LED INTEGRADO 3000K 55X55 6870Lms 24V 44W
2145-32	50	67	9	LED INTEGRADO 3000K 50X67 7300Lms 24V 47W

2145-33	40	47	9	LED INTEGRADO 4000K 5430Lms 24V 35W
2145-34	43	83	9	LED INTEGRADO 4000K 7800Lms 24V 51W
2145-35	55	55	9	LED INTEGRADO 4000K 55X55 6870Lms 24V 44W
2145-36	50	67	9	LED INTEGRADO 4000K 50X67 7300Lms 24V 47W

ARANDELA LUZ DIRETA

	L	C	H
3157-00	40	47	9
3157-01	43	83	9
3157-02	55	55	9
3157-03	50	67	9

3157-12	40	47	9	LED INTEGRADO 2700K 2090Lms 12V 25W
3157-13	43	83	9	LED INTEGRADO 2700K 3025Lms 12V 37W
3157-14	55	55	9	LED INTEGRADO 2700K 55X55 2640Lms 12V 32W
3157-15	50	67	9	LED INTEGRADO 2700K 50X67 2800Lms 12V 34W

3157-16	40	47	9	LED INTEGRADO 4000K 2090Lms 12V 25W
3157-17	43	83	9	LED INTEGRADO 4000K 3025Lms 12V 37W
3157-18	55	55	9	LED INTEGRADO 4000K 55X55 2640Lms 12V 32W
3157-19	50	67	9	LED INTEGRADO 4000K 50X67 2800Lms 12V 34W

ARANDELA LUZ INDIRETA

	L	C	H
3157-04	40	47	9
3157-05	43	83	9
3157-06	55	55	9
3157-07	50	67	9

3157-20	40	47	9	LED INTEGRADO 2700K 2090Lms 12V 25W
3157-21	43	83	9	LED INTEGRADO 2700K 3025Lms 12V 37W
3157-22	55	55	9	LED INTEGRADO 2700K 55X55 2640Lms 12V 32W
3157-23	50	67	9	LED INTEGRADO 2700K 50X67 2800Lms 12V 34W

3157-24	40	47	9	LED INTEGRADO 4000K 2090Lms 12V 25W
3157-25	43	83	9	LED INTEGRADO 4000K 3025Lms 12V 37W
3157-26	55	55	9	LED INTEGRADO 4000K 55X55 2640Lms 12V 32W
3157-27	50	67	9	LED INTEGRADO 4000K 50X67 2800Lms 12V 34W

ARANDELA LUZ DIRETA E INDIRETA

	L	C	H
3157-08	40	47	9
3157-09	43	83	9
3157-10	55	55	9
3157-11	50	67	9

3157-28	40	47	9	LED INTEGRADO 2700K 2090Lms 12V 25W
3157-29	43	83	9	LED INTEGRADO 2700K 3025Lms 12V 37W
3157-30	55	55	9	LED INTEGRADO 2700K 55X55 2640Lms 12V 32W
3157-31	50	67	9	LED INTEGRADO 2700K 50X67 2800Lms 12V 34W

3157-32	40	47	9	LED INTEGRADO 4000K 2090Lms 12V 25W
3157-33	43	83	9	LED INTEGRADO 4000K 3025Lms 12V 37W
3157-34	55	55	9	LED INTEGRADO 4000K 55X55 2640Lms 12V 32W
3157-35	50	67	9	LED INTEGRADO 4000K 50X67 2800Lms 12V 34W



PERFIS

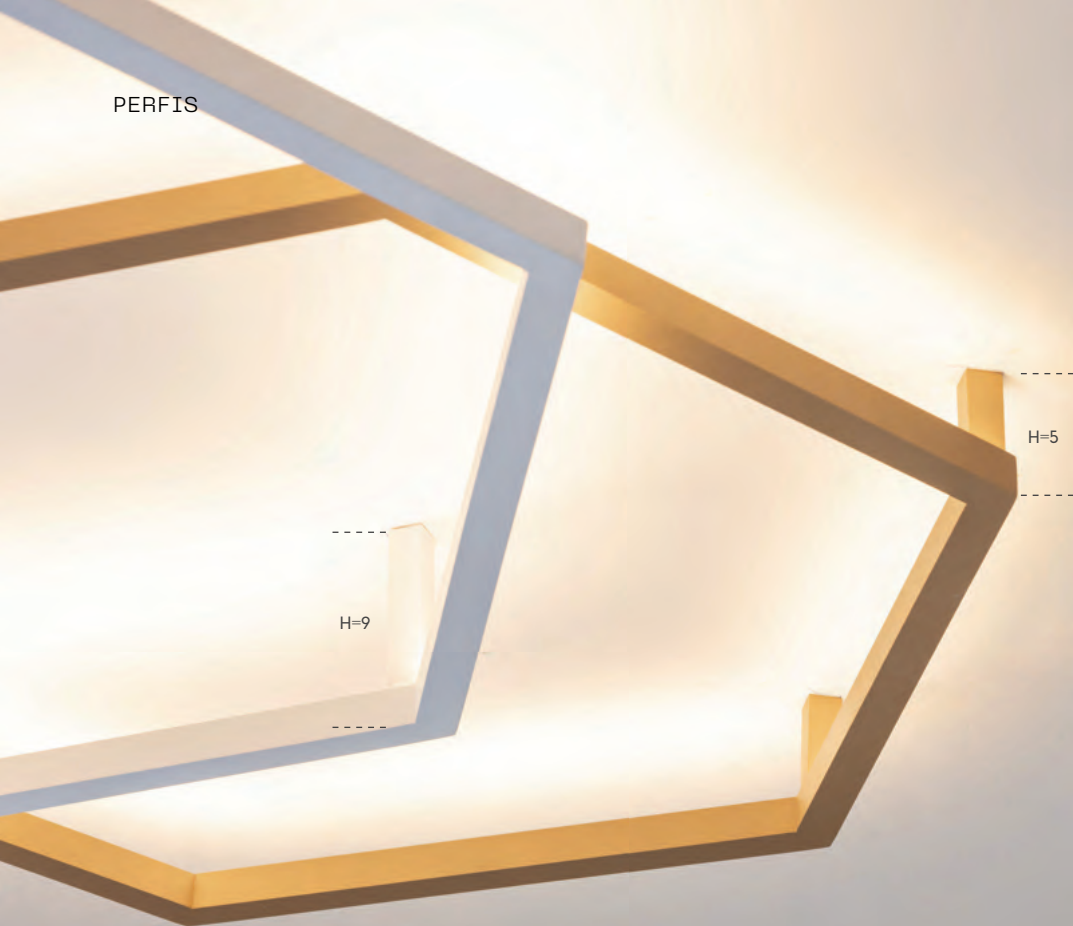

HEXA

LUMINÁRIA EM ALUMÍNIO COM ACABAMENTO EM PINTURA ELETROSTÁTICA E DIFUSOR EM POLICARBONATO

FORNE NÃO INCLUSA

PREVER ALOJAMENTO PARA FONTE REMOTA

MEDIDAS EM CENTÍMETROS

ARANDELA LUZ DIRETA H=5

	L	C	H
3158-00	35	40	5
3158-01	43	50	5
3158-02	52	60	5
3158-03	61	70	5
3158-04	26	80	5
3158-05	26	120	5

ARANDELA LUZ DIRETA H=9

	L	C	H
3158-06	35	40	9
3158-07	43	50	9
3158-08	52	60	9
3158-09	61	70	9
3158-10	26	80	9
3158-11	26	120	9

PLAFON LUZ DIRETA H=5

	L	C	H
2141-00	35	40	5
2141-01	43	50	5
2141-02	52	60	5
2141-03	61	70	5
2141-04	26	80	5
2141-05	26	120	5

PLAFON LUZ DIRETA H=9

	L	C	H
2141-06	35	40	9
2141-07	43	50	9
2141-08	52	60	9
2141-09	61	70	9
2141-10	26	80	9
2141-11	26	120	9

ARANDELA LUZ INDIRETA H=5

	L	C	H
3158-36	35	40	5
3158-37	43	50	5
3158-38	52	60	5
3158-39	61	70	5
3158-40	26	80	5
3158-41	26	120	5

ARANDELA LUZ INDIRETA H=9

	L	C	H
3158-42	35	40	9
3158-43	43	50	9
3158-44	52	60	9
3158-45	61	70	9
3158-46	26	80	9
3158-47	26	120	9

PLAFON LUZ INDIRETA H=5

	L	C	H
2141-36	35	40	5
2141-37	43	50	5
2141-38	52	60	5
2141-39	61	70	5
2141-40	26	80	5
2141-41	26	120	5

PLAFON LUZ INDIRETA H=9

	L	C	H
2141-42	35	40	9
2141-43	43	50	9
2141-44	52	60	9
2141-45	61	70	9
2141-46	26	80	9
2141-47	26	120	9

PENDENTE LUZ DIRETA

	L	C	H	H MAX
1196-00	35	40	2.5	150
1196-01	43	50	2.5	150
1196-02	52	60	2.5	150
1196-03	61	70	2.5	150
1196-04	26	80	2.5	150
1196-05	26	120	2.5	150

PENDENTE LUZ INDIRETA

	L	C	H	H MAX
1196-19	35	40	2.5	150
1196-20	43	50	2.5	150
1196-21	52	60	2.6	150
1196-22	61	70	2.7	150
1196-23	26	80	2.5	150
1196-24	26	120	2.5	150

ARANDELA LED INTEGRADO - LUZ DIRETA H=5

	L	C	H	
3158-12	35	40	5	LED INTEGRADO 2700K 1440Lm 12V 18W
3158-13	43	50	5	LED INTEGRADO 2700K 1800Lm 12V 21W
3158-14	52	60	5	LED INTEGRADO 2700K 2160Lm 12V 26W
3158-15	61	70	5	LED INTEGRADO 2700K 2520Lm 12V 31W
3158-16	26	80	5	LED INTEGRADO 2700K 2280Lm 12V 28W
3158-17	26	120	5	LED INTEGRADO 2700K 3240Lm 12V 39W
3158-18	35	40	5	LED INTEGRADO 4000K 1440Lm 12V 18W
3158-19	43	50	5	LED INTEGRADO 4000K 1800Lm 12V 21W
3158-20	52	60	5	LED INTEGRADO 4000K 2160Lm 12V 26W
3158-21	61	70	5	LED INTEGRADO 4000K 2520Lm 12V 31W
3158-22	26	80	5	LED INTEGRADO 4000K 2280Lm 12V 28W
3158-23	26	120	5	LED INTEGRADO 4000K 3240Lm 12V 39W

ARANDELA LED INTEGRADO - LUZ DIRETA H=9

	L	C	H	
3158-24	35	40	9	LED INTEGRADO 2700K 1440Lm 12V 18W
3158-25	43	50	9	LED INTEGRADO 2700K 1800Lm 12V 21W
3158-26	52	60	9	LED INTEGRADO 2700K 2160Lm 12V 26W
3158-27	61	70	9	LED INTEGRADO 2700K 2520Lm 12V 31W
3158-28	26	80	9	LED INTEGRADO 2700K 2280Lm 12V 28W
3158-29	26	120	9	LED INTEGRADO 2700K 3240Lm 12V 39W
3158-30	35	40	9	LED INTEGRADO 4000K 1440Lm 12V 18W
3158-31	43	50	9	LED INTEGRADO 4000K 1800Lm 12V 21W
3158-32	52	60	9	LED INTEGRADO 4000K 2160Lm 12V 26W
3158-33	61	70	9	LED INTEGRADO 4000K 2520Lm 12V 31W
3158-34	26	80	9	LED INTEGRADO 4000K 2280Lm 12V 28W
3158-35	26	120	9	LED INTEGRADO 4000K 3240Lm 12V 39W

ARANDELA LED INTEGRADO - LUZ INDIRETA H=5

	L	C	H	
3158-47	35	40	5	LED INTEGRADO 2700K 1440Lm 12V 18W
3158-48	43	50	5	LED INTEGRADO 2700K 1800Lm 12V 21W
3158-49	52	60	5	LED INTEGRADO 2700K 2160Lm 12V 26W
3158-50	61	70	5	LED INTEGRADO 2700K 2520Lm 12V 31W
3158-51	26	80	5	LED INTEGRADO 2700K 2280Lm 12V 28W
3158-52	26	120	5	LED INTEGRADO 2700K 3240Lm 12V 39W
3158-53	35	40	5	LED INTEGRADO 4000K 1440Lm 12V 18W
3158-54	43	50	5	LED INTEGRADO 4000K 1800Lm 12V 21W
3158-55	52	60	5	LED INTEGRADO 4000K 2160Lm 12V 26W
3158-56	61	70	5	LED INTEGRADO 4000K 2520Lm 12V 31W
3158-57	26	80	5	LED INTEGRADO 4000K 2280Lm 12V 28W
3158-58	26	120	5	LED INTEGRADO 4000K 3240Lm 12V 39W

ARANDELA LED INTEGRADO - LUZ INDIRETA H=9

	L	C	H	
3158-59	35	40	9	LED INTEGRADO 2700K 1440Lm 12V 18W
3158-60	43	50	9	LED INTEGRADO 2700K 1800Lm 12V 21W
3158-61	52	60	9	LED INTEGRADO 2700K 2160Lm 12V 26W
3158-62	61	70	9	LED INTEGRADO 2700K 2520Lm 12V 31W
3158-63	26	80	9	LED INTEGRADO 2700K 2280Lm 12V 28W
3158-64	26	120	9	LED INTEGRADO 2700K 3240Lm 12V 39W
3158-65	35	40	9	LED INTEGRADO 4000K 1440Lm 12V 18W
3158-66	43	50	9	LED INTEGRADO 4000K 1800Lm 12V 21W
3158-67	52	60	9	LED INTEGRADO 4000K 2160Lm 12V 26W
3158-68	61	70	9	LED INTEGRADO 4000K 2520Lm 12V 31W
3158-69	26	80	9	LED INTEGRADO 4000K 2280Lm 12V 28W
3158-70	26	120	9	LED INTEGRADO 4000K 3240Lm 12V 39W

PERFIS



HEXA

LUMINÁRIA EM ALUMÍNIO COM
ACABAMENTO EM PINTURA ELETROSTÁTICA
E DIFUSOR EM POLICARBONATO

FORNECIDA SEM FONTE DE ALIMENTAÇÃO
PREVER ALOJAMENTO PARA FONTE REMOTA
MEDIDAS EM CENTÍMETROS

PLAFON LED INTEGRADO - LUZ DIRETA H=5

	L	C	H	
2141-12	35	40	5	LED INTEGRADO 3000K 3750LM 24V 24W
2141-13	43	50	5	LED INTEGRADO 3000K 5400LM 24V 30W
2141-14	52	60	5	LED INTEGRADO 3000K 6480LM 24V 36W
2141-15	61	70	5	LED INTEGRADO 3000K 7560LM 24V 42W
2141-16	26	80	5	LED INTEGRADO 3000K 5930LM 24V 38W
2141-17	26	120	5	LED INTEGRADO 3000K 8430LM 24V 54W
2141-18	35	40	5	LED INTEGRADO 4000K 3750LM 24V 24W
2141-19	43	50	5	LED INTEGRADO 4000K 5400LM 24V 30W
2141-20	52	60	5	LED INTEGRADO 4000K 6480LM 24V 36W
2141-21	61	70	5	LED INTEGRADO 4000K 7560LM 24V 42W
2141-22	26	80	5	LED INTEGRADO 4000K 5930LM 24V 38W
2141-23	26	120	5	LED INTEGRADO 4000K 8430LM 24V 54W

PLAFON LED INTEGRADO - LUZ DIRETA H=9

	L	C	H	
2141-24	35	40	9	LED INTEGRADO 3000K 3750LM 24V 24W
2141-25	43	50	9	LED INTEGRADO 3000K 5400LM 24V 30W
2141-26	52	60	9	LED INTEGRADO 3000K 6480LM 24V 36W
2141-27	61	70	9	LED INTEGRADO 3000K 7560LM 24V 42W
2141-28	26	80	9	LED INTEGRADO 3000K 5930LM 24V 38W
2141-29	26	120	9	LED INTEGRADO 3000K 8430LM 24V 54W
2141-30	35	40	9	LED INTEGRADO 4000K 3750LM 24V 24W
2141-31	43	50	9	LED INTEGRADO 4000K 5400LM 24V 30W
2141-32	52	60	9	LED INTEGRADO 4000K 6480LM 24V 36W
2141-33	61	70	9	LED INTEGRADO 4000K 7560LM 24V 42W
2141-34	26	80	9	LED INTEGRADO 4000K 5930LM 24V 38W
2141-35	26	120	9	LED INTEGRADO 4000K 8430LM 24V 54W

PENDENTE LED INTEGRADO - LUZ DIRETA

	L	C	H	H MAX	
1196-06	35	40	2.5	150	LED INTEGRADO 3000K 3750LM 24V 24W
1196-07	43	50	2.5	150	LED INTEGRADO 3000K 5400LM 24V 30W
1196-08	52	60	2.5	150	LED INTEGRADO 3000K 6480LM 24V 36W
1196-09	61	70	2.5	150	LED INTEGRADO 3000K 7560LM 24V 42W
1196-10	26	80	2.5	150	LED INTEGRADO 3000K 5930LM 24V 38W
1196-11	26	120	2.5	150	LED INTEGRADO 3000K 8430LM 24V 54W
1196-12	35	40	2.5	150	LED INTEGRADO 4000K 3750LM 24V 24W
1196-13	43	50	2.5	150	LED INTEGRADO 4000K 5400LM 24V 30W
1196-14	52	60	2.5	150	LED INTEGRADO 4000K 6480LM 24V 36W
1196-15	61	70	2.5	150	LED INTEGRADO 4000K 7560LM 24V 42W
1196-16	26	80	2.5	150	LED INTEGRADO 4000K 5930LM 24V 38W
1196-17	26	120	2.5	150	LED INTEGRADO 4000K 8430LM 24V 54W

PLAFON LED INTEGRADO - LUZ INDIRETA H=5

	L	C	H	
2141-48	35	40	5	LED INTEGRADO 3000K 3750LM 24V 24W
2141-49	43	50	5	LED INTEGRADO 3000K 5400LM 24V 30W
2141-50	52	60	5	LED INTEGRADO 3000K 6480LM 24V 36W
2141-51	61	70	5	LED INTEGRADO 3000K 7560LM 24V 42W
2141-52	26	80	5	LED INTEGRADO 3000K 5930LM 24V 38W
2141-53	26	120	5	LED INTEGRADO 3000K 8430LM 24V 54W
2141-54	35	40	5	LED INTEGRADO 4000K 3750LM 24V 24W
2141-55	43	50	5	LED INTEGRADO 4000K 5400LM 24V 30W
2141-56	52	60	5	LED INTEGRADO 4000K 6480LM 24V 36W
2141-57	61	70	5	LED INTEGRADO 4000K 7560LM 24V 42W
2141-58	26	80	5	LED INTEGRADO 4000K 5930LM 24V 38W
2141-59	26	120	5	LED INTEGRADO 4000K 8430LM 24V 54W

PLAFON LED INTEGRADO - LUZ INDIRETA H=9

	L	C	H	
2141-60	35	40	9	LED INTEGRADO 3000K 3750LM 24V 24W
2141-61	43	50	9	LED INTEGRADO 3000K 5400LM 24V 30W
2141-62	52	60	9	LED INTEGRADO 3000K 6480LM 24V 36W
2141-63	61	70	9	LED INTEGRADO 3000K 7560LM 24V 42W
2141-64	26	80	9	LED INTEGRADO 3000K 5930LM 24V 38W
2141-65	26	120	9	LED INTEGRADO 3000K 8430LM 24V 54W
2141-66	35	40	9	LED INTEGRADO 4000K 3750LM 24V 24W
2141-67	43	50	9	LED INTEGRADO 4000K 5400LM 24V 30W
2141-68	52	60	9	LED INTEGRADO 4000K 6480LM 24V 36W
2141-69	61	70	9	LED INTEGRADO 4000K 7560LM 24V 42W
2141-70	26	80	9	LED INTEGRADO 4000K 5930LM 24V 38W
2141-71	26	120	9	LED INTEGRADO 4000K 8430LM 24V 54W

PENDENTE LED INTEGRADO - LUZ INDIRETA

	L	C	H	H MAX	
1196-25	35	40	2.5	150	LED INTEGRADO 3000K 3750LM 24V 24W
1196-26	43	50	2.5	150	LED INTEGRADO 3000K 5400LM 24V 30W
1196-27	52	60	2.5	150	LED INTEGRADO 3000K 6480LM 24V 36W
1196-28	61	70	2.5	150	LED INTEGRADO 3000K 7560LM 24V 42W
1196-29	26	80	2.5	150	LED INTEGRADO 3000K 5930LM 24V 38W
1196-30	26	120	2.5	150	LED INTEGRADO 3000K 8430LM 24V 54W
1196-31	35	40	2.5	150	LED INTEGRADO 4000K 3750LM 24V 24W
1196-32	43	50	2.5	150	LED INTEGRADO 4000K 5400LM 24V 30W
1196-33	52	60	2.5	150	LED INTEGRADO 4000K 6480LM 24V 36W
1196-34	61	70	2.5	150	LED INTEGRADO 4000K 7560LM 24V 42W
1196-35	26	80	2.5	150	LED INTEGRADO 4000K 5930LM 24V 38W
1196-36	26	120	2.5	150	LED INTEGRADO 4000K 8430LM 24V 54W



SPOT FOX

SPOT EM ALUMÍNIO COM ACABAMENTO
EM PINTURA ELETROSTÁTICA

ADAPTADOR DE TRILHO NÃO INCLUSO

4185	SPOT FOX MINIDICRÓICA COM CANOPLA HASTE P
4186	SPOT FOX AR70 COM CANOPLA HASTE P
4187	SPOT FOX PAR20 COM CANOPLA HASTE P
4188	SPOT FOX MINIDICRÓICA COM CANOPLA HASTE G
4189	SPOT FOX AR70 COM CANOPLA HASTE G
4190	SPOT FOX PAR20 COM CANOPLA HASTE G
4191	SPOT FOX MINIDICRÓICA PARA TRILHO HASTE P
4192	SPOT FOX AR70 PARA TRILHO HASTE P
4193	SPOT FOX PAR20 PARA TRILHO HASTE P
4194	SPOT FOX MINIDICRÓICA PARA TRILHO HASTE G
4195	SPOT FOX AR70 PARA TRILHO G
4196	SPOT FOX PAR20 PARA TRILHO HASTE G

PERFIS



SPOT BOTTI

SPOT EM ALUMÍNIO COM ACABAMENTO
EM PINTURA ELETROSTÁTICA

ADAPTADOR DE TRILHO NÃO INCLUSO

4066	SPOT BOTTI DICRÓICA COM CANOPLA
4068	SPOT BOTTI AR70 COM CANOPLA
4069	SPOT BOTTI PAR20 COM CANOPLA
4070	SPOT BOTTI AR111 COM CANOPLA
4071	SPOT BOTTI PAR30 COM CANOPLA
4072	SPOT BOTTI DICRÓICA TRILHO
4074	SPOT BOTTI AR70 TRILHO
4075	SPOT BOTTI PAR20 TRILHO
4076	SPOT BOTTI AR111 TRILHO
4077	SPOT BOTTI PAR30 TRILHO



CONCEPTU

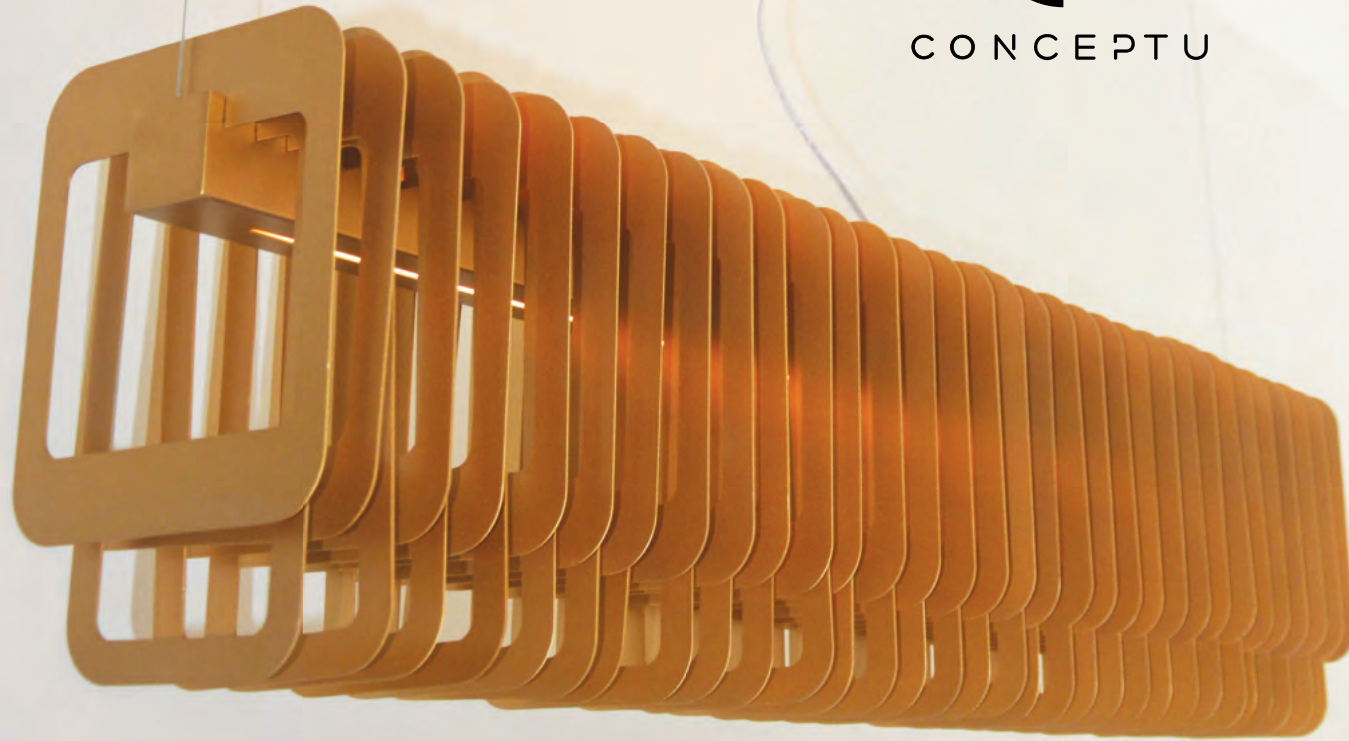

**JUNTOS,
ILUMINANDO
NOVOS CAMINHOS**

CONFIRA TAMBÉM NOSSOS CATÁLOGOS **ORIGINS** E **CLÁSSICOS**.



EXPEDIENTE

Fotografias

DIVULGAÇÃO

Projeto Gráfico

TUMTUM DESIGN & BRANDING

www.tumtum.design

[@tumtumbranding](https://www.instagram.com/tumtumbranding)

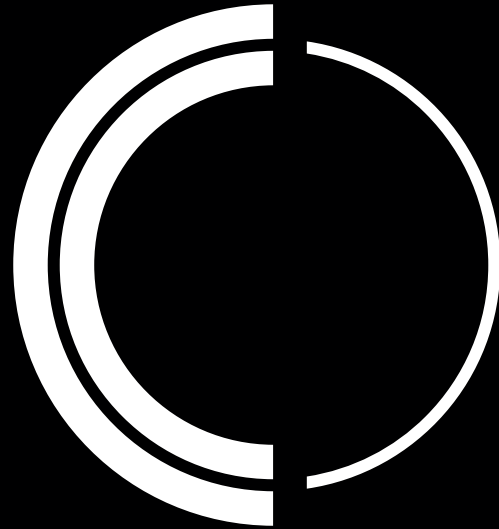

CONCEPTU

 @conceptuiluminacao

| www.conceptuiluminacao.com.br |

conceptu@conceptuiluminacao.com.br