



 **GERMANY**
EXCLUSIVE

MARUNI

Contemplação, aconchego e refúgio.

Luminárias inspiradas para conectar a casa e a natureza.

Assinada com exclusividade pelo Asadesign Studio para a

Germany Iluminação Externa.



 **GERMANY**
EXCLUSIVE

Portfólio único com personalidade, robustez, elegância e atemporalidade.

Germany Exclusive, nasceu do desejo de trazer design para a iluminação dos ambientes externos, tornando-os inesquecíveis e deslumbrantes.

Projetos com beleza impecável que remetem a uma verdadeira obra de arte.

O resultado é uma produção em formato industrial, mas em escala artesanal. Encontrando a flexibilidade necessária para criar inovação e exclusividade.

ÍNDICE

| | |
|-------------------------------|----|
| Metais e Cordas..... | 08 |
| Abertura..... | 10 |
| Pendente Maruni ø350mm..... | 14 |
| Pendente Maruni ø500mm..... | 16 |
| Arandela Maruni..... | 18 |
| Lanterna Maruni | 20 |
| Luminária de Chão Maruni..... | 22 |
| Luminária de Mesa Maruni..... | 24 |
| Plafon Maruni..... | 26 |

METAIS E CORDAS

Os tons e as texturas do mundo natural trazem essa essência para os ambientes, lembrando-nos de nossa conexão com o mundo ao nosso redor, a resiliência da natureza e a serenidade que ela nos traz.

As luminárias Maruni têm estrutura em aço-carbono, com geometria e rigidez estrutural impecáveis. A resistência e qualidade do acabamento são assegurados pela pintura eletrostática, nas cores preto, branco e corten. E o encantamento da coleção, a corda náutica de 6mm, artesanalmente tramada por mãos brasileiras, está disponível em uma paleta de cores cuidadosamente selecionada para harmonizar-se com os tons da natureza.

Branco Fosco e Preto Fosco para criar contrastes simples e minimalistas. Corten para cor e microtextura.

METAIS

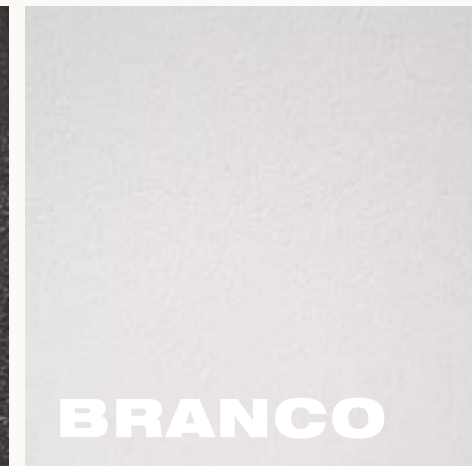

CORDAS

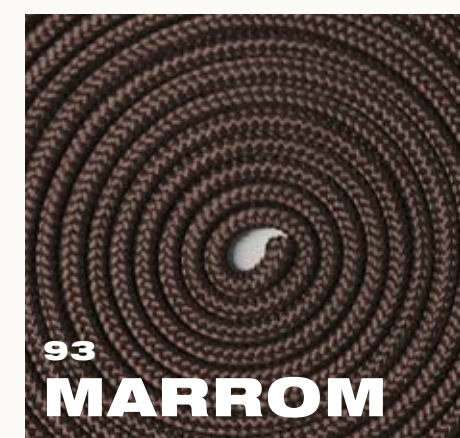



A varanda e a área externa coberta são os espaços onde a casa e a natureza se encontram.

É sentir-se próximo à natureza, seja ouvindo o canto dos pássaros, apreciar a brisa leve tocando o rosto ou o cheiro da chuva molhando a terra.

Neste ambiente as sensações se misturam e permitem que o conforto do lar receba elementos da vida ao ar livre.

Formada por luminária de chão, luminária de mesa, pendentes em dois tamanhos, plafon, arandela e lanterna, Maruni tem suas formas inspiradas na delicada campânula que, ao abrir, forma a flor da *Fuchsia Hybrida*.

A realza das flores é generosa e atrai beija-flores ao jardim. Também conhecida como brinco-de-princesa, é uma planta delicada e muito apreciada pela sua graça, elegância e diversidade de cores.

Maruni by

Asadesign





Base branca e corda areia



Base branca e corda areia



Base preta e corda cinza



Base branca e corda verde musgo



PENDENTE MARUNI Ø350MM

Especificações

Soquete 1xE27
 Potência máxima de 60W
 Tensão 100-240V | 50/60Hz
 Corrente 127V | 220V - 4A
 Corpo em aço e alumínio
 Cúpula em corda náutica
 Cabo em tecido ajustável
 Peso líquido 1,07kg
 Garantia de 1 ano
 IP 20

Lâmpadas indicadas

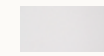
Filamento LED A60
 Filamento LED ST64

-  Ref. 48310160
-  Ref. 48310110
-  Ref. 48310260

Consulte combinações na pág. 28

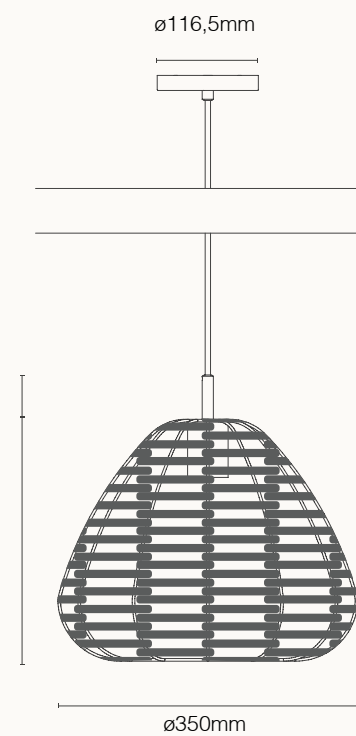



Base corten e corda marrom

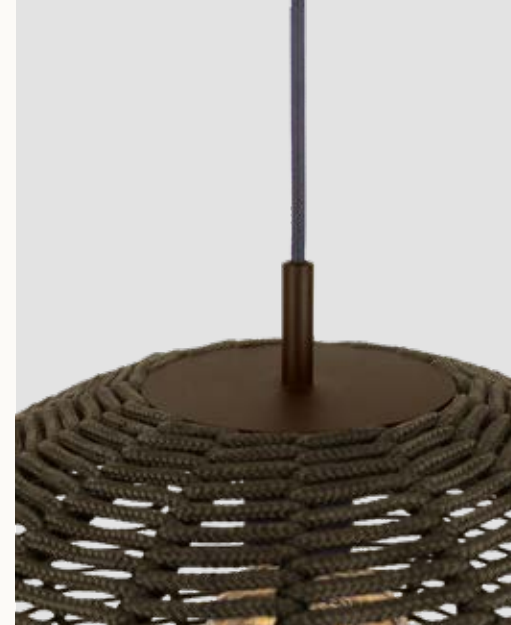

Base corten e corda marrom

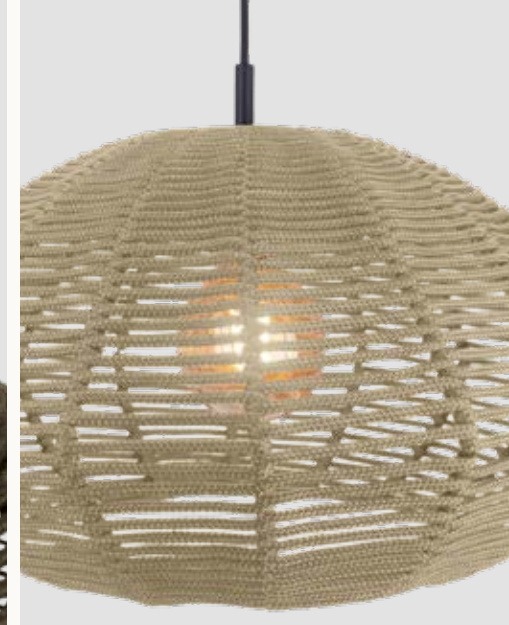

Base preta e corda areia



Base corten e corda azul marinho



PENDENTE MARUNI Ø500MM

Especificações

Soquete 1xE27
 Potência máxima de 60W
 Tensão 100-240V | 50/60Hz
 Corrente 127V | 220V - 4A
 Corpo em aço e alumínio
 Cúpula em corda náutica
 Cabo em tecido ajustável
 Peso líquido 1,50kg
 Garantia de 1 ano
 IP 20

Lâmpadas indicadas

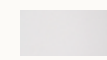
Filamento LED A60
 Filamento LED G95

| | |
|---|---------------|
|  | Ref. 48300160 |
|  | Ref. 48300110 |
|  | Ref. 48300260 |

Consulte combinações na pág. 28

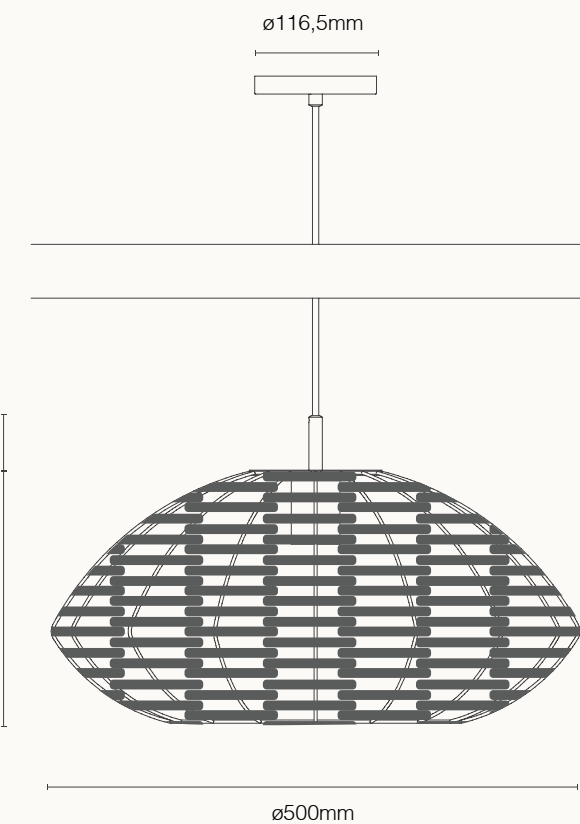



Base branca e corda azul marinho

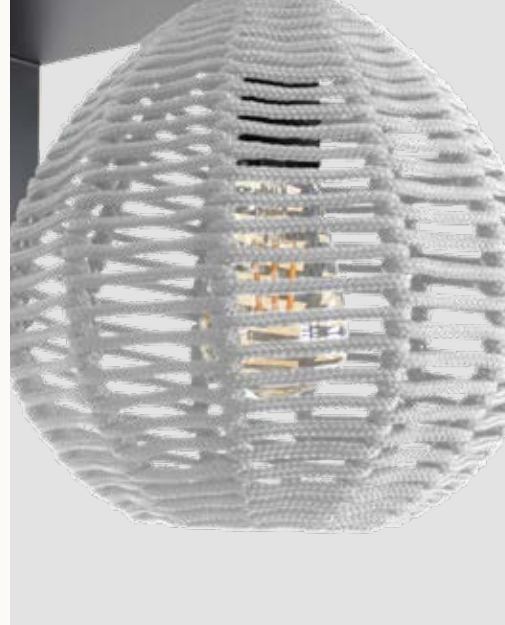

Base preta e corda branca



Base corten e corda areia



Base corten e corda areia



ARANDELA MARUNI

Especificações

Soquete 1xE27
 Potência máxima de 60W
 Tensão 100-240V | 50/60Hz
 Corrente 127V | 220V - 4A
 Corpo em aço e alumínio
 Cúpula em corda náutica
 Peso líquido 0,94kg
 Garantia de 1 ano
 IP 20

Lâmpadas indicadas

Filamento LED A60
 Filamento LED ST64

-  Ref. 48100160
-  Ref. 48100110
-  Ref. 48100260

Consulte combinações na pág. 28

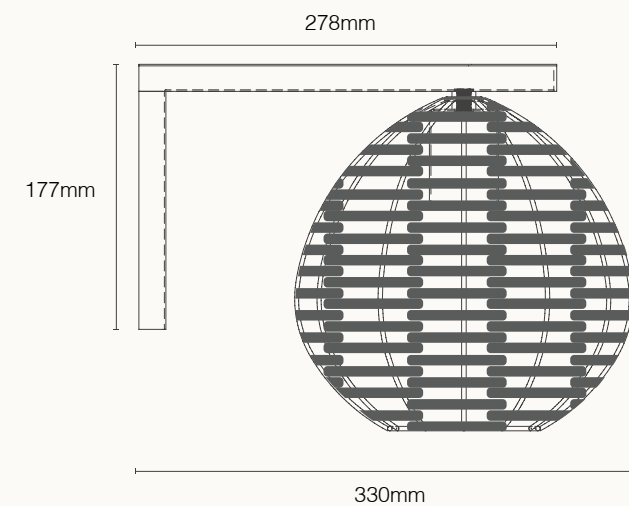
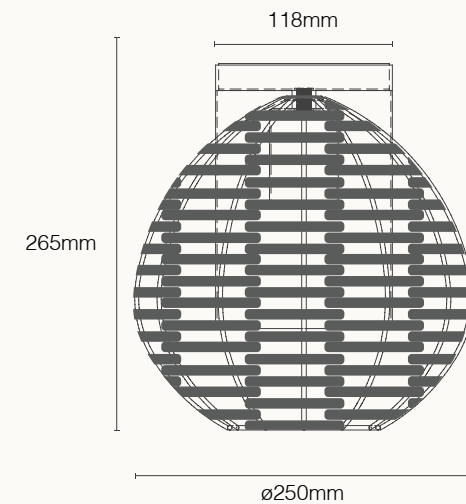



Base branca e corda natural



Base preta e corda areia



Base corten e corda azul marinho



Base preta e corda verde musgo



LANTERNA MARUNI

Especificações

Soquete 1xE27
Potência máxima de 60W
Tensão 100-240V | 50/60Hz
Corrente 127V | 220V - 4A
Corpo em aço e alumínio
Cúpula em corda náutica
Cabo em tecido com interruptor e plugue
Peso líquido 0,84kg
Garantia de 1 ano
IP 20

Lâmpadas indicadas

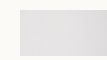
Filamento LED A60
Filamento LED G45

| | |
|---|---------------|
|  | Ref. 48800160 |
|  | Ref. 48800110 |
|  | Ref. 48800260 |

Consulte combinações na pág. 28

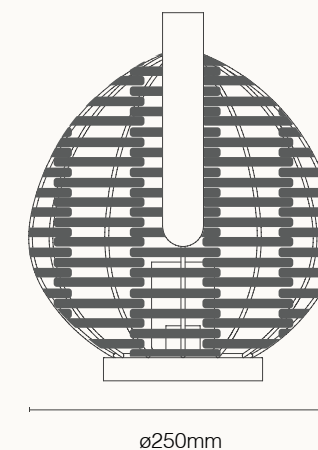

ø250mm

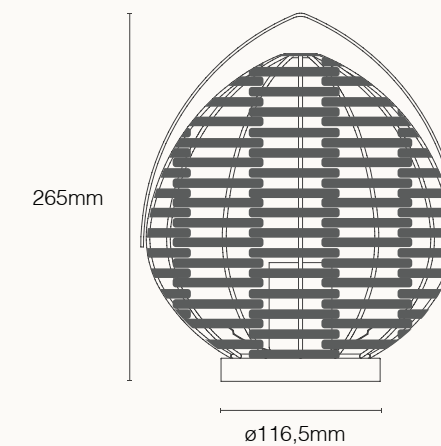

265mm

ø116,5mm

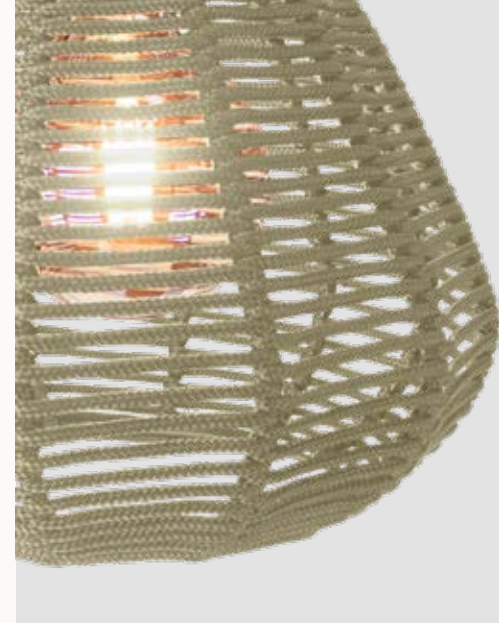

Base branca e corda areia



Base branca e corda marrom



Base preta e corda natural



LUMINÁRIA DE CHÃO MARUNI

Especificações

- Soquete 1xE27
- Potência máxima de 60W
- Tensão 100-240V | 50/60Hz
- Corrente 127V | 220V - 4A
- Corpo em aço e alumínio
- Cúpula em corda náutica
- Cabo em tecido com interruptor de chão e plugue
- Peso líquido 4,50kg
- Garantia de 1 ano
- IP 20

Lâmpadas indicadas

- Filamento LED G95
- Filamento LED ST64

-  Ref. 48700160
-  Ref. 48700110
-  Ref. 48700260

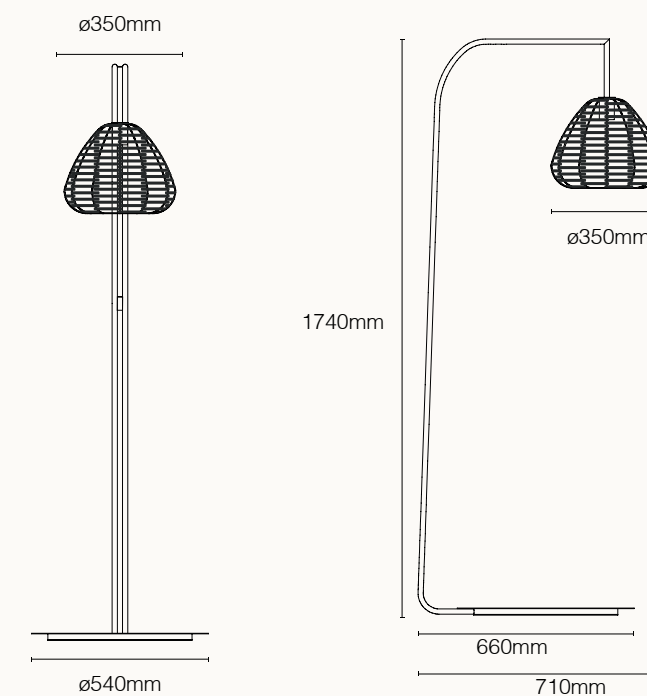



Base preta e corda verde musgo



Base preta e corda areia



Base branca e corda cinza



Base corten e corda areia

LUMINÁRIA DE MESA MARUNI

Especificações

Soquete 1xE27
Potência máxima de 60W
Tensão 100-240V | 50/60Hz
Corrente 127V | 220V - 4A
Corpo em aço e alumínio
Cúpula em corda náutica
Cabo em tecido com interruptor e plugue
Peso líquido 1,56kg
Garantia de 1 ano
IP 20

Lâmpadas indicadas

Filamento LED A60
Filamento LED G45

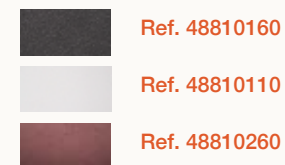

Consulte combinações na pág. 28

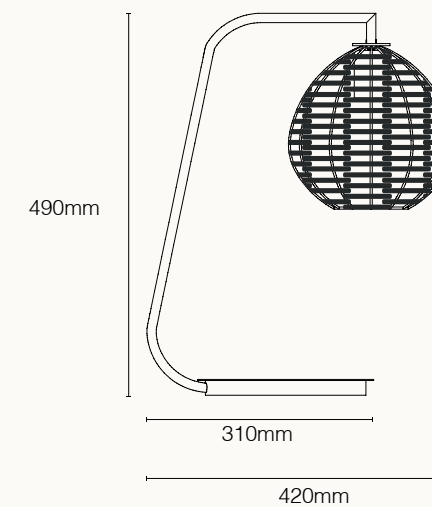
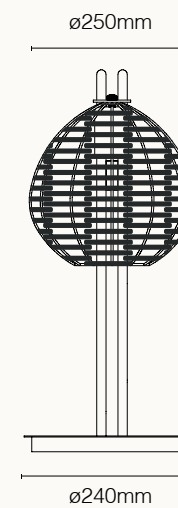



Base preta e corda cinza



Base preta e corda azul marinho

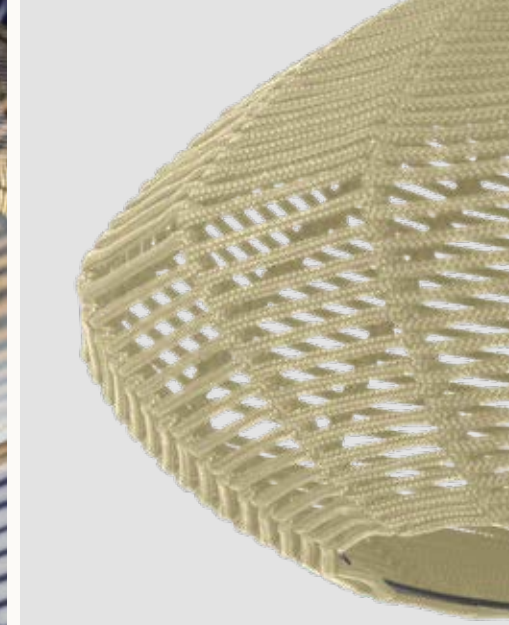

Base preta e corda areia

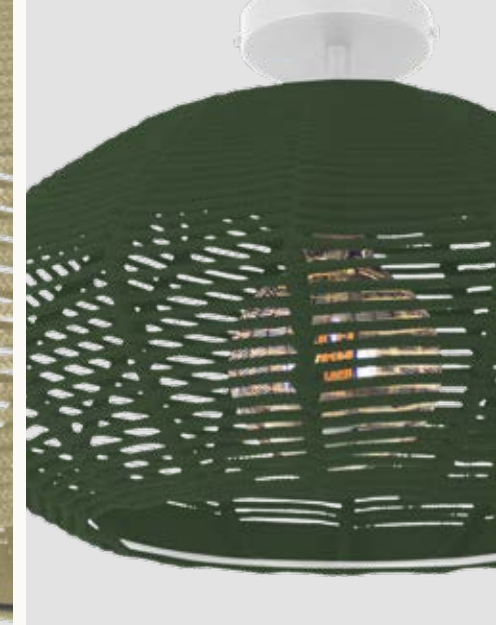

Base branca e corda verde musgo



PLAFON MARUNI

Especificações

Soquete 1xE27
Potência máxima de 60W
Tensão 100-240V | 50/60Hz
Corrente 127V | 220V - 4A
Corpo em aço e alumínio
Cúpula em corda náutica
Peso líquido 1,55kg
Garantia de 1 ano
IP 20

Lâmpadas indicadas

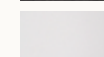
Filamento LED A60
Filamento LED G95

| | |
|---|---------------|
|  | Ref. 48900160 |
|  | Ref. 48900110 |
|  | Ref. 48900260 |

Consulte combinações na pág. 28

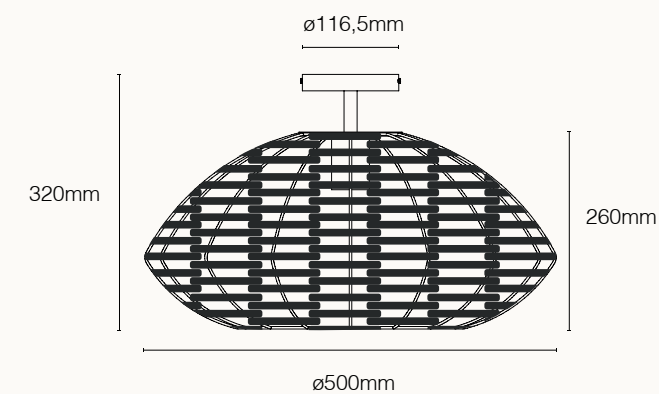

| Base | Corda | Pendente 350 | Pendente 500 | Arandela | Lanterna |
|-------------|----------------|---------------------|---------------------|-----------------|-----------------|
| Branco | Verde Musgo | 48310110-90 | 48300110-90 | 48100110-90 | 48800110-90 |
| Branco | Natural Branco | 48310110-91 | 48300110-91 | 48100110-91 | 48800110-91 |
| Branco | Areia | 48310110-92 | 48300110-92 | 48100110-92 | 48800110-92 |
| Branco | Marrom | 48310110-93 | 48300110-93 | 48100110-93 | 48800110-93 |
| Branco | Cinza | 48310110-94 | 48300110-94 | 48100110-94 | 48800110-94 |
| Branco | Azul Marinho | 48310110-95 | 48300110-95 | 48100110-95 | 48800110-95 |
| Preto | Verde Musgo | 48310160-90 | 48300160-90 | 48100160-90 | 48800160-90 |
| Preto | Natural Branco | 48310160-91 | 48300160-91 | 48100160-91 | 48800160-91 |
| Preto | Areia | 48310160-92 | 48300160-92 | 48100160-92 | 48800160-92 |
| Preto | Marrom | 48310160-93 | 48300160-93 | 48100160-93 | 48800160-93 |
| Preto | Cinza | 48310160-94 | 48300160-94 | 48100160-94 | 48800160-94 |
| Preto | Azul Marinho | 48310160-95 | 48300160-95 | 48100160-95 | 48800160-95 |
| Corten | Verde Musgo | 48310260-90 | 48300260-90 | 48100260-90 | 48800260-90 |
| Corten | Natural Branco | 48310260-91 | 48300260-91 | 48100260-91 | 48800260-91 |
| Corten | Areia | 48310260-92 | 48300260-92 | 48100260-92 | 48800260-92 |
| Corten | Marrom | 48310260-93 | 48300260-93 | 48100260-93 | 48800260-93 |
| Corten | Cinza | 48310260-94 | 48300260-94 | 48100260-94 | 48800260-94 |
| Corten | Azul Marinho | 48310260-95 | 48300260-95 | 48100260-95 | 48800260-95 |

| Base | Corda | Luminária Chão | Luminária Mesa | Plafon |
|-------------|----------------|-----------------------|-----------------------|---------------|
| Branco | Verde Musgo | 48700110-90 | 48810110-90 | 48900110-90 |
| Branco | Natural Branco | 48700110-91 | 48810110-91 | 48900110-91 |
| Branco | Areia | 48700110-92 | 48810110-92 | 48900110-92 |
| Branco | Marrom | 48700110-93 | 48810110-93 | 48900110-93 |
| Branco | Cinza | 48700110-94 | 48810110-94 | 48900110-94 |
| Branco | Azul Marinho | 48700110-95 | 48810110-95 | 48900110-95 |
| Preto | Verde Musgo | 48700160-90 | 48810160-90 | 48900160-90 |
| Preto | Natural Branco | 48700160-91 | 48810160-91 | 48900160-91 |
| Preto | Areia | 48700160-92 | 48810160-92 | 48900160-92 |
| Preto | Marrom | 48700160-93 | 48810160-93 | 48900160-93 |
| Preto | Cinza | 48700160-94 | 48810160-94 | 48900160-94 |
| Preto | Azul Marinho | 48700160-95 | 48810160-95 | 48900160-95 |
| Corten | Verde Musgo | 48700260-90 | 48810260-90 | 48900260-90 |
| Corten | Natural Branco | 48700260-91 | 48810260-91 | 48900260-91 |
| Corten | Areia | 48700260-92 | 48810260-92 | 48900260-92 |
| Corten | Marrom | 48700260-93 | 48810260-93 | 48900260-93 |
| Corten | Cinza | 48700260-94 | 48810260-94 | 48900260-94 |
| Corten | Azul Marinho | 48700260-95 | 48810260-95 | 48900260-95 |



A originalidade de nosso design resulta da aliança criativa entre profissionais de grande talento, sólida formação técnica, olhar atento para as tendências e gosto pelo desafio. Confrontamos ideias e mesclamos arte e tecnologia, para que cada projeto seja único. Desse processo, resulta um estilo de design perene e bem-sucedido, de qualidade reconhecida no Brasil e no exterior.

Asadesign



Para conhecer o nosso portfólio completo, aponte a câmera do seu celular para o QR code abaixo.



